



aerospace
climate control
electromechanical
filtration
fluid & gas handling
hydraulics
pneumatics
process control
sealing & shielding



Thermoplastic Hose for Hydraulics & Industry

Catalogue 4460-UK



ENGINEERING YOUR SUCCESS.



Hüttenfeld / Germany



Wissembourg / France



Almelo / Netherlands



Ravenna / Ohio



Stafford / Texas

For Your Safety!

Hose assemblies are used to transmit various kinds of fluids at considerable pressures. The critical zone of a hose assembly is the connection between flexible hose and rigid fitting (crimping area). Only the use of original **polyflex**® components (hose, fittings and tooling) and full compliance with the **polyflex**® assembly instructions can guarantee safety and conformity with standards.

When making and testing hose assemblies in connection with the respective field of application the guidelines and technical regulations as well as protection and hazard prevention rulings must be adhered to.

You as the manufacturer of **polyflex**® hose assemblies are obliged to mark the hose assemblies according to the regulations.

Non-compliance with these rules can lead to the failure of a hose assembly and the loss of warranty.

- !** - *Introduction and general statements*
- A** - *Hose and fitting selection*
- B** - *Push-Lok® hose and fittings*
- C** - *PTFE/Fluoropolymer hose and fittings*
- D** - *Hose and fittings for alternative fuels*
- E** - *Hose and fittings for hydraulic and industrial applications*
- F** - *Accessories*
- G** - *Workshop equipment*
- H** - *Technical information*
- I** - *Index of part numbers*

Parker Hannifin

- Polyflex Division

Parker Hannifin offers an extensive programme of systems and components for fluid technology. Parker is structured by sales offices and manufacturing divisions to guarantee optimum focus on our customers' demands and market interests at any time.

The Polyflex division, with headquarters located in Hüttenfeld, Germany, provides thermoplastic hoses and tubes. These are applied in a variety of different markets such as standard hydraulics, ultra high pressure applications, and oil & gas industry. As a market leader in many areas and with a unique product range we are pleased to assist you with all your queries.

This catalogue includes hoses and fittings for a pressure range up to 70 MPa. The indicated fittings are always adapted to the correspondent hose and offer optimum performance.

Other catalogues with thermoplastic hoses:

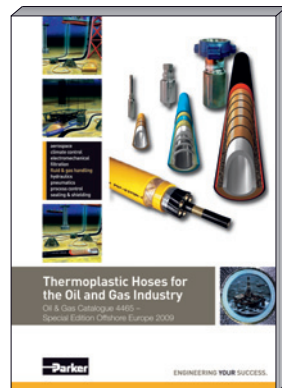
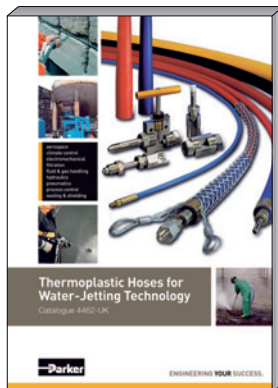



Introduction and general statements

Why should Parker thermoplastic hoses be your first choice?	IV
Practical examples.....	VII
Our services – We go the extra distance.....	VIII
Parker fittings and crimpers – Always the right connection.....	IX
The Parkrimp system.....	X
Part number system.....	XI
Explanation of symbols	XII

Why should Parker thermoplastic hoses be your first choice?

Listed below are the many reasons why you should consider Parker thermoplastic hoses for your next hydraulic or pneumatic application. This summary gives an overview of the features, advantages, and benefits of our fine and extensive line of thermoplastic hoses. Each hose is described in detail within this catalogue. We suggest reviewing this section before you proceed with your selection.

Easy and quick installation

- Very small sizes starting with inner diameters of 2 mm (DN2 or -012). Typical disadvantages such as extensive costs, waste of space, extensive weight, and complicated installation, which are caused by using oversized hoses, can be avoided.
- Lightweight by design – more than 50% weight reduction compared to conventional hydraulic hoses possible.
- Very small outer diameters due to compact design.
- Small bend radii to save installation space.
- Preformed hose assemblies acc. to customer's requirements.
Combine the advantages of
 - formed steel pipes and
 - flexible hose assemblies
- Long continuous hose lengths up to 4000 m help minimise scrap due to unusable cut-off pieces and often render connection joints unnecessary.
- Wide range of colours for easy identification of hose function and to harmonise the appearance of machine and hose.
- Easy cutting and processing, especially with textile fibre reinforced hose types.

Outstanding performance

- Very high working pressures up to 400 MPa (see special catalogue 4462 "Thermoplastic Hoses for Ultra High Pressure").
- Reduced pressure loss due to smooth core tubes.
- Electrically non-conductive hoses according to SAE J517.
- Volumetric expansion according to customers needs.
- High purity of the extremely smooth core tube reduces the danger of contamination of the hydraulic system caused by deposits in the hose.
- Excellent abrasion resistance.
- High collapse pressure.
- Long shelf life.
- Individual customer hose bundles.
- Customer specific hose marking.

Dedicated features

- Outstanding chemical resistance
 - of hose outer cover against environmental effects
 - of hose core tube against fluids
- Long life time due to excellent UV and ozone resistance.
- Sea water resistant hose materials.
- Wide temperature range from -73°C up to 232°C.
- Easy bonding of hoses together into twinline or multiline assemblies to achieve space saving and compact units.
- Suitable for industrial gases.

Applications and products

Wide range of applications

- Standard hydraulics
- Mini hydraulics
- Industrial hydraulics
- Mobile hydraulics
- Chemical industry
- Process engineering
- Industrial gases
- Alternative fuels
- Automotive and truck industry
- Boats and yachts
- Pneumatics

Products

- Push-Lok® self-grip hoses
- PTFE hoses and tubes
- Paint spray hoses
- Gas hoses
- Hoses for alternative fuels
- Hydraulic hoses
- Fittings
- Crimping presses and accessories



Practical examples



Our services

- We go the extra distance

- Parker Store**
 - Competent service for hydraulic & pneumatic systems**
Just in case - Broad product range – At close quarters – Trained personnel

- HOSE DOCTOR®**
 - Emergency Hose Repair and Replacement Service**
Immediate help – On site – Minimised downtimes – Proven Parker quality

- Parker® Tracking System**
 - Unique like a fingerprint**
Exactly your line – Just one call

- Parker Store Container Service**
 - Transportable complete workshop – Wherever you want – Complete service at the construction site*

- Technical Services & customised modifications**
 - Parker engineers – Conception – Installation – Individual modifications*

- Kitting**
 - Personalised Orders**
Modules – Only one reference number – Specially labelled packing units

- Breadman**
 - Delivery to the manufacturer's assembly line – Just in time – Stocks are reduced*

Parker fittings and crimpers **- Always the right connection**

Chromium-6 Free

Since 1st July 2007 the EU End-of-life Vehicle Directive (ELV) came into force.

European Community Directive 2000/53/EG of 27th July 2002 includes:

- Directive manages vehicle recycling
- Prohibition on the use of chromium-6, mercury and lead with specified exceptions and the prohibition of cadmium
- Metallic chromium and chromium-3 compounds may still be used

Chromium-6 has been classified in the EU Directive 67/548/ EWG as Category 2, which means that this material can under certain circumstances act as a carcinogenic. Skin contact can bring about allergic reactions.

Since 2006, all Parker steel fittings have been manufactured using trivalent chromate (Chromium-6-Free) plating. This new process enhances the corrosion resistance of the fittings, and is more environmentally friendly than the previous hexavalent chromate plating. While the fitting function will not change, the colour is now silver instead of gold. The new plating process is implemented worldwide at all Parker facilities.

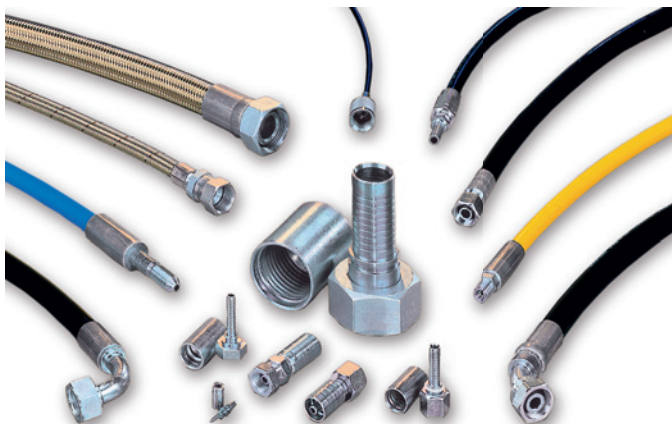

The Parkrimp system

Parker has developed a global system which offers a secure and functional crimping process without extensive training or complex machinery. The crimper provides a stop position. Thus there is no need for the user to make complicated adjustments – just use the correct combination of hose, fitting and die set.

The Parkrimp® crimping tools have been designed especially for Parflex® hoses. The die set segments are joined together and each die set is marked with identification grooves for quick assignment to the fitting series. Additionally they are colour coded with respect to the fitting size. Parkrimp® crimping tools are suitable for Parkrimp®, KaryKrimp® and MiniKrimp® crimping presses.

Of course Parker thermoplastic hoses can be assembled also with free adjustable crimpers. Please refer to pages H-1 ff. for the related crimp diameters and assembly procedures.





Part number system

Hoses



2370 N - 06 V10

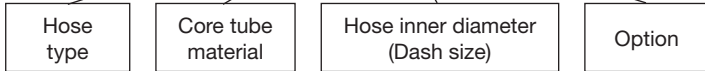



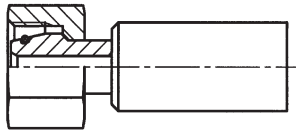



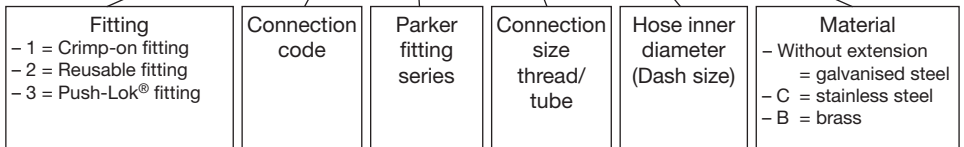



Fittings



1 C9 9X - 12 - 06 C



Explanation of symbols

Symbol	Definition	Symbol	Definition
#	Part number		Volumetric expansion
	Hose ID		Weight
	Hose OD		Thread size
	Working Pressure		Hex size
	Burst pressure		Diameter
	Minimum bend radius		Vacuum

Chapter A**Hose and fitting selection**

Hose selection.....	A-2
Hose selection by application.....	A-4
Hose selection by working pressure and ID	A-6
Hose selection by fluid compatibility/chemical resistance	A-8
Hose selection by standards and approvals.....	A-14
Determination of hose size	A-15
Pressure drop.....	A-16
Fitting selection.....	A-17
Fittings overview	A-18
Fittings cross reference table.....	A-24

Hose selection

Several criteria must be considered, when selecting the optimal hose for your application. According to the particular application there is – as a rule – at least one of these characteristics crucial for the selection. In this section you will find the most important criteria and relevant selection guidelines.



Hose selection

1) Hose selection by application

This overview designates some application ranges together with hoses, which have proved to be especially suited for the associated application. Please note that only the most important applications can be listed. Moreover, the suitability of the desired hose for the individual environmental conditions must be verified.

2) Hose selection by working pressure and ID

When working pressure and ID are given, use this table to select the possible hoses for the desired pressure range.

3) Hose selection by fluid compatibility/chemical resistance

Many applications require highly chemical resistant materials due to aggressive media. The table lists chemical fluids and rating codes for different hose materials.

4) Hose selection by standards and approvals

This overview lists hose types by international standards, approvals and certificates.

5) Determination of hose size

If you are not sure about the hose ID suitable for your application, the flow capacity nomogram and the pressure drop chart will assist you in selecting the correct hose size.

1) Hose selection by application

Application	Hose type														
	2010N	2010H	2020N	830M	838M	515H	550H	540N	560	510A	518C	1202LT	55LT	PTA	2040N
2-component systems															
Aluminium plants					●						●				
Cranes							●		●						
Chemical industry															
Steam applications															
Diagnosis & test systems	●		●												
Compressed-air systems				●	●										
Electrically non-conductive applications					●						●				
Energy chains							●								
Earth-moving machines/construction machines		●	●			●	●	●	●						
Paint spray systems (airless)															●
Fire fighting equipment															●
Motor and Sailing boats			●			●	●	●							●
Gas applications	●		●							●					●
Operating tables	●	●	●												
Platforms for lifting persons							●				●				
Hot melt applications															
High temperature applications															
Lifting devices/fork-lifts							●					●	●		
Cooling systems										●					
Agricultural machinery		●	●			●	●	●	●						
Food industry															
Mini hydraulics	●	●	●			●	●	●				●			●
General hydraulics			●			●	●		●						
Motors															
PU foaming															
Tyre press machines															
Hose reels							●								
Lubricating systems	●	●				●	●	●						●	
Welding robots				●											
Solar plants	●		●			●	●								
Telehandler	●		●												
Cryogenic applications (dynamic & static)												●	●		
Pilot lines	●	●				●	●								
Machine tools			●				●	●							
Wind turbines															
Page															
	E-3	E-3	E-4	B-2	B-3	E-6	E-7	E-8	E-9	E-10	E-11	E-12	E-13	E-15	E-16

Note: Please refer also to our safety guide when selecting hoses (page H-34 ff.)

2) Hose selection by working pressure and ID

Pressure and ID / Hose selection by working pressure

Hose selection	Working pressure (MPa)																Fitting series	P.	
	nom. size	DN	2	2.5	3	4	5	6	8	10	12	16	20	25	32	40			50
	size	-012	-016	-02	-025	-03	-04	-05	-06	-08	-10	-12	-16	-20	-24	-32			
	mm	2.0	2.4	3.2	4.0	4.8	6.4	7.9	9.5	12.7	15.9	19.0	25.4	31.8	38.1	50.8			
inch	5/64	3/32	1/8	5/32	3/16	1/4	5/16	3/8	1/2	5/8	3/4	1	1 1/4	1 1/2	2				
Push-Lok® hose																			
830M							1.6		1.6	1.6	1.6	1.6					82	B-2	
838M							1.6		1.6	1.6	1.6	1.6					82	B-3	
PTFE-/FEP hose																			
2030T					27.5	24.0	20.0	17.5	15.0	12.5	10.0	8.0					YX	C-3	
2030T-##R14						21.0	21.0	17.5	14.0	10.3	8.3	6.9					91N	C-4	
2030T-##CON						17.2	15.5	13.8	10.3	8.3	6.9	4.6	3.4				PC	C-5	
2030TB-##CON						17.2	15.5	13.8	10.3	8.3	6.9	4.6	3.4				PC	C-6	
2033T						27.5	25.0	22.5	20.0	17.5	15.0	11.0					PX/YX	C-7	
919U						21.0		17.5	14.0		8.3	6.9					91N	C-8	
929/929B						21.0		17.5	14.0		8.4	8.8					91N	C-9	
939/939B								10.3	9.5	6.9	7.5	6.9	6.9	5.0	1.7		93N	C-10	
2380F						42.5	37.5	35.0	32.5	30.0	27.5	22.5					NX	C-11	
2246F						41.5	37.5	34.0	32.5	30.0	26.5	21.0					NX	C-12	
Hose for alternative fuels																			
5CNG						34.5	34.5		34.5	34.5		34.5	34.5				55.58.58H	D-2	
8LPG						3.0	3.0	3.0	3.0								PX-LPG	D-4	
Small bore hose/Mini hydraulic hose																			
2010N	27.5																EX	E-3	
2010H				21.0													EX	E-3	
2020N (V30)	47.5	40.0	40.0	44.0													EX	E-4	
2020N (V50)	63.0			50.0													EX	E-4	
Medium pressure hose																			
515H						15.0	14.0	12.0	10.0	10.0							54	E-6	
550H						22.5	21.0	17.5	15.5	14.0	10.0	8.5	7.0				55/56	E-7	
540N			17.5			21.0	19.0	17.5	15.5	14.0	8.5						55/56/57	E-8	
560						24.0	22.5	21.0	19.0	17.5	14.0	12.0					55/56	E-9	
510A						21.0	19.0		15.5	14.0							55/56	E-10	
518C			17.5			22.5	20.7	17.5	15.5	15.5	10.5	8.5	7.0				55/56/57/58	E-11	
1202LT						21.0	21.0	21.0	21.0	21.0							55/56	E-12	
55LT			21.0			22.5	21.0	17.5	15.5	14.0		8.5					55/56/57	E-13	

nom. size		Working pressure (MPa)															Fitting series	P.	
		DN	2	2.5	3	4	5	6	8	10	12	16	20	25	32	40			50
		size	-012	-016	-02	-025	-03	-04	-05	-06	-08	-10	-12	-16	-20	-24			-32
		mm	2.0	2.4	3.2	4.0	4.8	6.4	7.9	9.5	12.7	15.9	19.0	25.4	31.8	38.1			50.8
inch	5/64	3/32	1/8	5/32	3/16	1/4	5/16	3/8	1/2	5/8	3/4	1	1 1/4	1 1/2	2				
High pressure hose																			
PTA				37.0		25.5	22.5	19.0									AF/AB	E-15	
2040N (V00)			35.0		34.0	31.0	25.0	24.0	18.5	14.0	12.5	10.0					56/PX	E-16	
2040N (V30)					37.5	31.0	25.0	24.0	19.5								PX	E-16	
2040H					34.0	31.0	25.0	24.0	18.5	14.0	12.5	10.0					56/PX	E-17	
520N					34.5	34.5	31.0	27.5	24.0								55/56	E-18	
528N					34.5	34.5	31.0	27.5	24.0								55/56	E-19	
580N						34.5		27.5	24.0	19.0	15.5	14.0					56/58	E-20	
588N						34.5		27.5	24.0	19.0	15.5	14.0					56/58	E-21	
590					34.5	34.5		27.5	24.0	21.0	17.5	14.0					55/56/58	E-22	
575X					34.5	34.5		34.5	34.5								55/56	E-23	
2370N						46.5	44.0	42.0	35.0								9X/NX	E-24	
2370H									30.0								9X	E-24	
2245N						45.0	40.0	37.5	35.0	33.0	30.0	27.5					NX	E-25	
2244N													27.5				NX	E-25	
Paint spray hose																			
2040N			35.0		34.0	31.0	25.0	24.0	18.5	14.0	12.5	10.0					56/PX	E-28	
2370N						46.5	44.0	42.0	35.0								9X/NX	E-29	
2030T					27.5	24.0	20.0	17.5	15.0	12.5	10.0	8.0					YX	E-30	
2033T						27.5	25.0	22.5	20.0	17.5	15.0	11.0					PX/YX	E-31	
Gas hose																			
2040N (V00)					34.0	31.0	25.0	24.0	18.5	14.0	12.5	10.0					56/PX	E-37	
2040N (V7_)						31.0											PX	E-38	
526BA					41.4	41.4		41.4									55	E-39	
5CNG					34.5	34.5		34.5	34.5		34.5	34.5					55. 58. 58H	E-40	
8LPG					3.0	3.0	3.0	3.0									PX-LPG	E-41	

3) Hose selection by fluid compatibility/ chemical resistance

Ratings code

- G : Good to excellent. Little or no swelling, tensile or surface changes. Preferred choice.
- L : Marginal or conditional. Noticeable effects but not necessarily indicating lack of safety. Further testing suggested for specific application.
- P : Poor or unsatisfactory. Not recommended without extensive and realistic testing.
- : Indicates that this was not tested.
- * : Biopetroleum must be tested individually due to its varying composition.

Material codes for hose core tubes		<i>polyflex</i> [®] / <i>Parflex</i> [®] Part No.
H	Polyester elastomer	2040H, 2370H, 515H, 518C, 550H, 55LT, 560, 590, 1202LT
N	Polyamide	2010N, 2020N, 2040N, 2244N, 2245N, 2370N, 520N, 528N, 540N, 575X, 580N, 588N, PTA, 8LPG
NC	Nylon copolymer	510A, 5CNG
TFE	Polytetrafluoroethylene (PTFE)	2030T (V70, R14, CON), 2033T, 929/929B, 939/939B, 919U
Material codes for hose covers		
U	Polyurethane	2010N, 2040N (V00), 2040H, 2244N, 2245N, 2370H, 2370N, 510, 830, 838, 515H, 510A, 540N, 550H, 560, 520N, 528N, 580N, 588N, 590, 919U, 5CNG
HF	Special elastomer	55LT, 1202LT
PFX	Special elastomer	518C
N	Polyamide	2010N, 2020N, 2040N (V30), 2245N, 2244N, 8LPG
Material code for sealing components		
V	NBR	

Notes on the chemical resistance table

- (1) The fluid resistance tables are simplified rating tabulations based on immersion tests at 24 °C. Higher temperatures tend to reduce ratings. Since final selection depends on pressure, fluid and ambient temperature and other factors not known to Parker Hannifin, no performance guarantee is expressed or implied. The indications do not imply any compliance with standards and regulations and do not refer to possible changes of colour, taste or smell. For food and drinking water specially approved materials have to be used. For fluids not listed or for advice on particular applications, please consult Parker Hannifin GmbH, **polyflex**® Division in Hüttenfeld, Germany.
- (2) Hose applications for these fluids must take into account legal and insurance regulations. The chemical resistance indicated does not express or imply approval by certain institutions.
- (3) Satisfactory at some concentrations and temperatures, unsatisfactory at others.
- (4) For gas applications, the cover should be pin-pricked and the pressure must not be released quickly. Special safety guard accessories are to be used to prevent damage or personal injury in the event of failure.
- (5) Chemical resistance does not imply low permeation rates. Please consult Parker Hannifin GmbH for a recommendation for your specific requirements.
- (6) The indication of chemical resistance does not imply any special food compatibility; it refers only to the chemical resistance of the material.
- (7) Chemical resistance does not imply acceptability for use in airless paint spray applications. These applications require a special, electrically conductive hose.

Hose and fitting selection

Hose selection by fluid compatibility/chemical resistance

Chemical	H	N	U	HF	V	NC	O	OC	PFX	HFR	FEP	TFE
Acetaldehyde	G	L	L	L	P	-	L	P	L	G	G	G
Acetic Acid Glacial	L	L	L	L	G	P	G	L	L	L	L	G
Acetone	L	G	P	P	P	G	P	P	P	L	G	G
Acetylene	-	-	-	-	-	-	-	-	-	-	-	-
Air (4)	G	G	G	G	G	G	G	G	G	G	G	G
Ammonium Chloride	G	P	G	G	G	P	G	G	G	G	L	G
Ammonium Hydroxyde	L	G	P	P	L	-	G	G	P	L	G	G
Anhydrous Ammonia	P	P	P	P	P	P	P	P	P	P	-	P
Aniline	P	P	P	P	P	P	L	P	P	P	G	G
Animal Oils (6)	G	G	G	G	G	G	P	P	G	G	-	G
Aromatic Hydrocarbons	L	G	L	L	P	G	P	-	L	L	-	G
Asphalt	G	G	G	G	G	G	L	L	G	G	L	G
Baygon (insecticide)	L	G	P	P	-	-	-	-	P	L	-	G
Beer	G	G	G	G	G	-	G	G	G	G	G	G
Benzene	L	G	L	L	P	L	P	P	L	L	G	G
Biopetroleum	*	*	*	*	*	*	*	*	*	*	*	*
Brake Fluid (DOT #3)	-	G	P	P	P	-	P	P	P	-	-	G
Butane (2) (4)	G	G	L	L	L	P	L	P	L	G	-	-
Butter (6)	G	G	G	G	G	-	G	G	G	G	-	G
Calcium Chloride	G	-	G	G	L	-	G	G	G	G	G	G
Carbon Dioxide (4)	G	G	G	G	G	G	G	G	G	G	-	-
Carbon Monoxide (4)	G	-	G	G	G	-	L	-	G	G	-	-
Carbon Tetrachloride	L	G	P	P	L	G	P	P	P	L	G	G
Castor Oil	G	L	L	L	G	L	P	P	L	G	-	G
Chlordane (insecticide)	L	G	P	P	-	-	-	-	P	L	-	-
Chlorinated Hydrocarbon Base Fluids	L	G	L	L	P	-	-	-	L	L	-	G
Chlorinated Petroleum Oil	G	G	L	L	-	L	-	-	L	G	-	-
Chlorinated Solvents	P	-	P	P	L	-	L	L	P	P	-	G
Chlorine, Gaseous, Dry	P	P	P	P	G	P	L	P	P	P	-	-
Chloroform	P	P	P	P	P	P	P	P	P	P	G	G
Chromic Acid	P	-	P	P	G	P	-	L	P	P	L	G
Citric Acid Solutions	G	G	L	L	G	G	G	G	L	G	G	G
Crude Petroleum Oil	G	G	G	G	G	G	P	P	G	G	-	G
Cyclohexane (2)	G	G	G	G	-	-	P	P	G	G	G	G
Cygon (insecticide)	L	G	P	P	-	-	-	-	P	L	-	-
Diazion (insecticide)	L	G	P	P	-	-	-	-	P	L	-	-
Diesel Fuel (2)	G	G	G	G	L	G	P	P	G	G	-	G
Diester Oils	L	G	P	P	P	-	P	P	P	L	-	G
Enamels	G	G	G	G	L	-	L	L	G	G	-	G
Ethanol (6)	G	G	L	L	L	L	G	G	L	G	-	G
Ethers	L	G	P	P	L	G	L	P	P	L	G	G
Ethylene Glycol	G	G	L	L	G	G	G	G	L	G	G	G
Ethylene Oxide	G	G	L	L	P	-	L	L	L	G	-	-
Fatty Acids	G	G	-	-	G	G	L	L	-	G	G	G
Formaldehyde	L	L	P	P	L	L	G	L	P	L	G	G
Formic Acid J	P	P	P	P	G	P	G	G	P	P	G	G

Hose selection

Chemical	H	N	U	HF	V	NC	O	OC	PFX	HFR	FEP	TFE
Freon 12 (5)	P	G	L	L	G	G	L	-	L	P	-	-
Freon 22 (5)	P	G	L	L	G	G	L	-	L	P	-	-
Fruit Juices	G	G	G	G	G	-	G	G	G	G	-	G
Fuel Oil (2)	G	G	L	L	L	G	P	P	L	G	G	G
Gas (Oil) (2)	G	G	G	G	G	G	P	P	G	G	-	G
Gasoline	G	G	-	-	P	G	P	P	-	G	G	G
Glue	-	-	-	-	-	-	-	-	-	-	-	-
Glycerine	G	G	L	L	G	G	G	G	L	G	G	G
Glycols (to 135 °F)	G	G	L	L	G	G	-	-	L	G	G	G
Grease (petroleum base)	G	G	G	L	G	G	L	L	G	G	-	G
Heptachlor (insecticide)	L	G	P	L	L	-	P	P	P	L	-	G
Hexane (2)	G	G	G	L	L	G	P	P	G	G	G	G
Houghto Safe-1000 Series (phosphate esters)	L	G	P	P	G	G	P	P	P	L	-	G
Houghto Safe-600 Series (hydraulic fluid)	G	G	L	L	G	G	G	L	L	G	-	G
Hydraulic Fluid (petroleum base)	G	G	G	G	G	G	L	L	G	G	L	G
Hydraulic Fluid (phosphate ester base)	L	G	L	L	L	G	P	P	P	L	-	G
Hydraulic Fluid (water glycol base)	G	G	G	G	L	G	-	-	G	G	-	G
Hydraulic Oil (petroleum base)	G	G	G	G	G	G	L	P	G	G	L	G
Hydrochloric Acid	P	L	P	P	L	P	L	P	P	P	G	G
Hydrofluoric Acid	P	P	P	P	L	P	L	P	P	P	G	G
Hydrolube (hydraulic fluid/water glycol base)	G	G	L	L	G	G	G	G	L	G	-	G
IRUS 902 (hydraulic fluid/water-oil emulsion)	G	G	G	G	G	G	L	P	G	G	-	G
Isocyanates (2)	L	L	L	L	P	-	L	P	L	L	-	G
Isooctane (2)	G	G	G	G	L	G	L	P	L	G	G	G
Isopropyl Alcohol	G	G	L	L	L	G	G	L	L	G	G	G
Kerosene (2)	G	G	L	L	L	G	L	P	P	G	G	G
Ketones	L	G	P	P	P	G	G	P	P	L	G	G
Lacquer Solvents	L	G	P	P	P	-	L	-	P	L	L	G
Lactic Acid	P	G	P	P	G	G	G	G	P	P	G	G
Lime (calcium oxide)	G	G	G	G	G	-	G	G	G	G	G	G
Lindol (hydraulic fluid/phosphate esters)	L	G	P	P	-	-	-	-	P	L	-	G
Linseed Oil	G	G	G	G	L	G	L	P	G	G	G	G
LP-Gas	-	-	-	-	-	-	-	-	-	-	-	-
Lubricating Oils (diester base)	L	G	P	P	-	G	-	-	P	L	-	G
Lubricating Oils (petroleum base)	G	G	G	G	G	G	L	P	G	G	G	G
Magnesium Hydroxide	L	G	L	L	G	-	G	G	L	L	G	G
Magnesium Salts	-	G	G	G	G	-	G	-	G	-	-	G
Malathion (insecticide)	L	G	P	P	-	-	-	-	P	L	-	G
Mercury	G	G	G	G	G	G	G	G	G	G	G	G
Meropa Oil (sulphur base)	G	G	-	-	-	-	-	-	-	-	-	G

Hose and fitting selection

Hose selection by fluid compatibility/chemical resistance

Chemical	H	N	U	HF	V	NC	O	OC	PFX	HFR	FEP	TFE
Methane	-	-	-	-	-	-	-	-	-	-	-	-
Methanol	G	G	P	P	P	G	L	P	P	G	-	G
Methoxychlor (insecticide)	L	G	P	P	-	-	-	-	P	L	-	G
Methyl Alcohol (6)	G	G	P	P	P	G	L	P	P	G	G	G
Methyl Ethyl Ketone (MEK)	L	G	P	P	P	G	G	L	P	L	G	G
Methyl Ethyl Ketone Peroxide (MEKP)	-	L	P	P	-	-	-	-	P	-	-	G
Methyl Isobutyl Ketone (MIBK)	L	G	P	P	P	G	L	P	P	L	G	G
Methylene Chloride	P	L	P	P	L	P	L	P	P	P	G	G
Milk (6)	G	G	G	G	G	-	G	G	G	G	G	G
Mineral Oil	G	G	G	G	G	G	L	P	G	G	G	G
Mineral Spirits	P	-	L	L	P	-	-	-	L	P	-	G
Motor Oils	G	G	G	G	G	G	-	-	G	G	G	G
Naphta	L	G	P	P	P	G	P	P	P	L	G	G
Natural Gas (4)	-	-	-	-	-	-	-	-	-	-	-	-
Nitric Acid	P	P	P	P	L	P	P	P	P	P	L	G
Nitrobenzene	P	G	P	P	P	G	P	P	P	P	G	G
Nitrogen, Gaseous (4) (5)	G	G	G	G	G	G	G	G	G	G	G	G
Nitrous Oxide	-	L	-	-	G	-	L	-	G	-	-	-
Oil (SAE)	G	G	G	G	G	G	L	L	G	G	-	G
Oil of Turpentine	G	G	P	P	G	G	P	P	P	G	-	G
Oleic Acid	G	G	G	G	L	G	L	L	G	G	G	G
OS 45 Type 3 Hydraulic Fluid (silicate esters)	L	G	L	L	P	-	P	P	L	L	-	-
Ozone	L	P	L	L	G	P	L	G	P	L	G	G
Paint (Oil Base) (7)	G	G	G	G	P	-	L	P	G	G	-	G
Paint Solvents (Oil base)	L	G	L	L	P	-	P	P	L	L	-	G
Pentane (2)	G	G	L	L	L	-	P	P	L	L	G	G
Perchloric Acid	P	P	P	P	L	P	P	P	P	P	L	G
Perchloroethylene	P	P	P	P	L	P	P	P	P	P	-	G
Petroleum Ether	-	-	-	-	P	-	P	P	-	-	-	-
Petroleum Oils	G	G	G	G	G	G	L	P	G	G	-	G
Phenols	P	P	P	P	L	P	P	P	P	P	-	G
Phosphate Esters (above 135 °F)	P	G	P	P	P	-	P	P	P	P	L	-
Phosphate Esters (to 135 °F)	G	G	P	P	P	G	P	P	P	G	-	G
Polyol Esters	L	G	P	P	P	-	-	-	P	L	-	G
Potassium Hydroxide, 50%	P	P	P	P	L	-	L	L	P	P	G	G
Propane (4) (5)	-	-	-	-	-	-	-	-	-	-	-	-
Propylene Glycol	-	-	G	G	G	-	G	L	-	-	G	G
Pydraul 312C, 625 (to 135 °F)	P	G	P	P	P	G	P	P	P	G	-	G
Pydraul F-9, 150, 160 (to 135 °F)	G	G	P	P	P	G	P	P	P	G	-	G
Quintolubric 822 Fluid	-	G	G	G	-	-	-	-	-	-	-	G
Salt Water	-	-	G	-	-	-	-	-	-	-	G	G
Sevin (insecticides in water)	G	G	G	G	-	-	-	-	G	G	-	G
Silicone Greases	G	G	G	G	G	G	-	-	G	G	-	G

Hose selection

Chemical	H	N	U	HF	V	NC	O	OC	PFX	HFR	FEP	TFE
Silicone Oils	G	G	G	G	G	G	-	-	G	G	-	G
Skydrol 500 & 7000	L	G	P	P	P	G	P	P	P	L	G	G
Soap Solutions	G	G	G	G	G	G	G	G	G	G	G	G
Soda Water	G	G	G	G	G	G	-	-	G	G	-	G
Sodium Borate	G	G	G	G	G	G	G	G	G	G	G	G
Sodium Carbonate	-	-	-	-	-	-	-	-	-	-	-	-
Sodium Chloride Solutions	G	G	G	G	G	-	G	-	G	G	G	G
Sodium Hydroxide, 50%	L	P	P	P	L	P	L	L	P	L	G	G
Sodium Hypochloride	L	P	P	P	L	-	-	-	P	L	G	G
Steam	P	P	P	P	P	P	P	P	P	P	G	G
Stoddard Solvent	P	G	P	P	L	G	P	P	P	P	G	G
Straight Synthetic Oils (phosphate esters)	L	G	P	P	P	G	-	-	P	L	-	G
Sulphur	G	G	G	P	G	-	L	G	G	G	G	G
Sulphur Dioxide	P	L	L	L	L	-	P	-	L	P	G	G
Sulphur Hexafluoride Gas (4) (5)	G	G	G	G	G	-	G	-	G	G	-	G
Sulphuric Acid	P	P	P	P	-	P	P	P	P	P	-	G
Toluol, Toluene	L	G	L	L	P	G	P	P	P	L	G	G
Transmission Fluid	G	G	G	G	P	G	-	-	G	G	-	G
Trichlorethylene	P	L	P	P	L	G	P	P	P	P	G	G
Trisodium Phosphate Solutions	L	G	P	P	G	G	G	G	P	L	G	G
Turpentine	G	G	L	L	L	G	P	P	P	G	G	G
Ucon (hydraulic fluid/water glycol base)	G	G	L	L	G	G	-	-	L	G	-	G
Varnish	G	G	G	G	P	G	G	L	G	G	-	G
Vinegar (6)	L	G	L	L	G	G	G	G	L	L	G	G
Water (above 60 °C) (6)	P	G	P	P	L	-	P	P	P	P	L	G
Water (to 60 °C) (6)	G	G	G	G	G	G	G	G	L	G	G	G
Water Glycols (above 60 °C)	P	G	P	P	L	-	P	P	P	P	-	G
Water Glycols (to 60 °C)	G	G	L	L	G	G	L	L	L	G	-	G
Water in oil Emulsions (above 60 °C)	P	G	P	P	L	-	-	-	P	P	-	G
Water in oil Emulsions (to 60 °C)	G	G	L	L	G	G	-	-	L	G	-	G
Whiskey, Wines (6)	G	G	L	L	G	G	G	G	G	G	G	G
Wood Oils	G	G	L	L	G	G	-	-	G	G	-	G
Xylene	L	G	P	P	P	G	P	P	P	L	G	G
Zinc Chloride	G	G	G	G	G	P	G	G	G	G	G	G

4) Hose selection by standards and approvals

Standards, approvals and certificates		<i>polyflex</i> [®] / <i>Parflex</i> [®] hose (page no.)
International standards	Pressure ratings for hydraulic service:	
	SAE 100R1	560 (E-9)
	SAE 100R2	590 (E-22)
	SAE 100R3	515H (E-6)
	SAE 100R7	550H (E-7), 540N (E-8), 510A (E-10), 518C (E-11), 55LT (E-13)
	SAE 100R8	520N (E-18), 528N (E-19), 580N (E-20), 588N (E-21)
	SAE 100R9	2245N / 2244N (E-25)
	SAE 100R14	2030T-##R14 (C-4)
	SAE 100R18	1202LT (E-12)
	ISO 3949 Typ R7	550H (E-7), 540N (E-8), 510A (E-10), 518C (E-11), 55LT (E-13)
	ISO 3949 Typ R8	520N (E-18), 528N (E-19), 580N (E-20), 588N (E-21)
	ISO 3949 Typ R18	1202LT (E-12)
	DIN EN 853-1SN	560 (E-9), 2040N (E-16), 2040H (E-17)
	DIN EN 853-2SN	2370N / 2370H (E-24)
	DIN EN 855 Typ R7	550H (E-7), 540N (E-8), 510A (E-10), 518C (E-11), 55LT (E-13)
	DIN EN 855 Typ R8	520N (E-18), 528N (E-19), 580N (E-20), 588N (E-21)
	Electrical non-conductivity:	
SAE J517	518C (E-11), 588N (E-21), 838M (B-3)	
Flame resistance:		
USCG, 46 CFR	520N, 540N, 550H, 560, 590, 919 (with fire sleeve)	
SAE J1942	919 (with fire sleeve)	
DIN 54837	528N-4 (E-19) with fire protection sleeve FS-S-11 (G-4)	
AS/NZS 1869	8LPG-3-FR, 8LPG-4-FR with additional flame resistant outer cover type -FR (D-4)	
Approvals and certificates	DNV (Det Norske Veritas):	
	Marine steel vessels, mobile and stationary offshore drilling units	540N (E-6), 560 (E-9), 520N (E-18), 580N (E-20), 588N (E-21), 590 (E-22), 575X (E-23), 2010N (E-3), 2020N (E-4), 2040N (E-16), 2040H (E-17), 2244N / 2245N (E-25)
	FDA approved material:	
	FDA 21 CFR 177.1550 (dry food contact)	2030T (C-3), 2030T-##R14 (C-4), 2030T-##CON (C-5), 2030TB-##CON (C-6), 2033T (C-7), 2246F (C-12), 2380F (C-11), 919U (C-8), 929 (C-9), 939 (C-10)
	German Lloyd:	
	92590-97HH	2040N for CO ₂ applications (E-37)
	CSA:	
	ANSI/IAS NGV4.2-CSA 12.52	5CNG (D-2)
	ECE:	
	ECE R110	5CNG-3 & 5CNG-8 (D-2)
ECE R67	8LPG-3, 8LPG-4, 8LPG-5, 8LPG-6 (D-4)	

5) Determination of hose size

Flow capacities of Parker hose at recommended flow velocities

The chart below is provided as an aid in the determination of the correct hose size.

Example:

At 10 gallons per minute (gal/min), what is the proper hose size within the recommended velocity range for pressure lines?

Locate 10 gallons per minute in the left-hand column and 25 feet per second in the right-hand column (the maximum recommended velocity range for pressure lines).

Lay a straight line across these two points. The inside diameter shown in the centre column is above -6 so we have to use -8 (1/2").

For suction lines, follow the same procedure except use recommended velocity range for intake lines in the right-hand column.

- where: Q = flow in gallons per minute (gal/min & l/min)
 V = velocity in feet per second (f/s & m/s)
 d = hose inside diameter (mm & dash size)

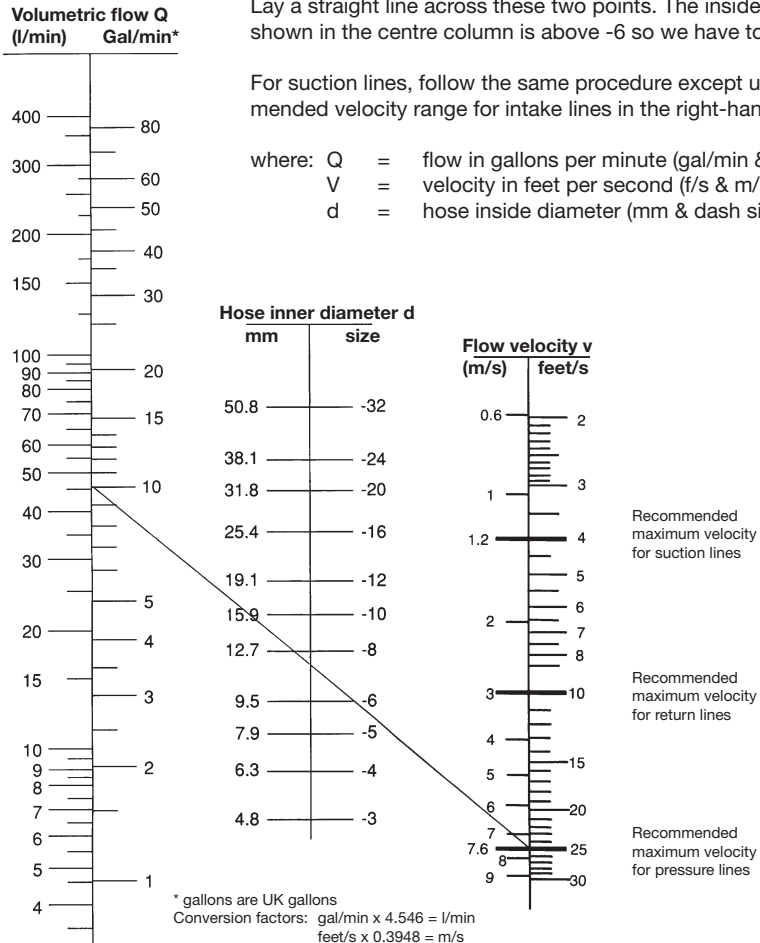

* Recommended velocities are according to hydraulic fluids of maximum viscosity 315 S.S.U. at 38 °C working at room temperature within 18 ° and 68 °C.

Hose selection

Pressure drop

When sizing hydraulic systems, internal pressure drops must be taken into account. These pressure drops result from friction loss of the flowing hydraulic fluids.

For calculation of the pressure drop in a straight line the following pressure loss diagram can be used, when flow quantity Q and nominal size are given.

The resulting pressure drop Δp applies to one metre line length.

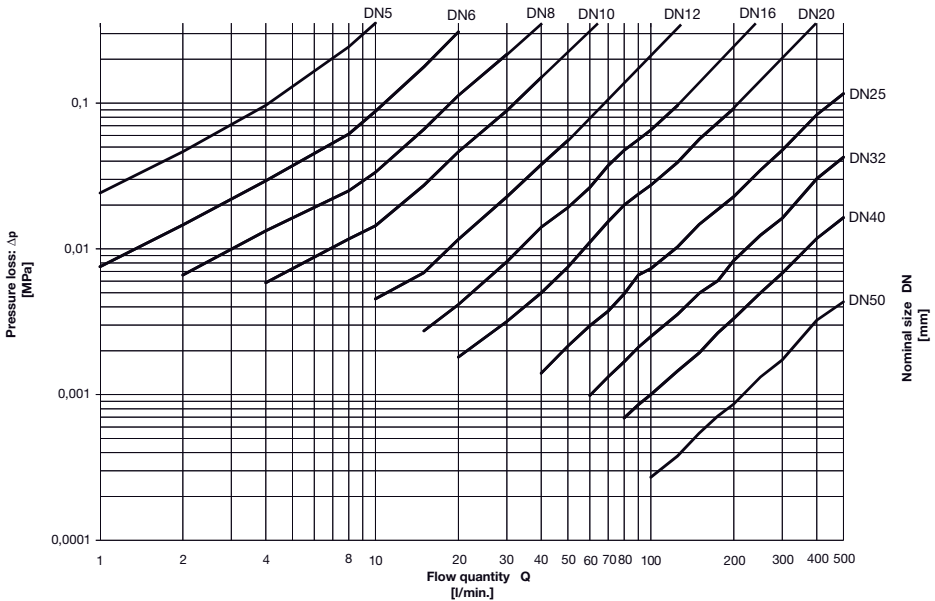

Fitting selection

Which is the approved fitting series for the selected hose?

For each hose type at least one fitting series is approved. Please refer to the related hose table contained in each hose description to find out which fitting series is available for the desired hose type.







Which is the correct fitting with the required end connection for the relevant hose assembly?

Each end connection in this catalogue has its own alphanumeric code. For example, the alphanumeric code for a DKOL connection with 90° elbow is "CF". Pages A-18 to A-23 show a complete overview of all end connections and the related codes.

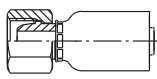
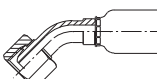
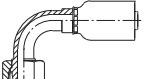
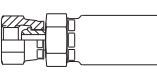
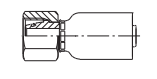
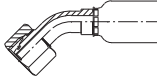
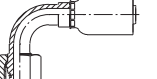
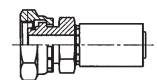
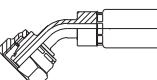
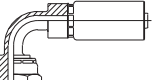
The fittings cross reference table on pages A-24 to A-26 lists the page numbers where the end connections of the different fitting series are located in this catalogue.

Fittings overview

Metric DIN fittings

<p>C3 Metric female swivel 24°/60°</p> <p>Light series – Metric swivel nut</p>  <table border="0"> <tr><td>54</td><td>.....</td><td>E-48</td></tr> <tr><td>55</td><td>.....</td><td>E-53</td></tr> <tr><td>56</td><td>.....</td><td>E-68</td></tr> <tr><td>91N</td><td>.....</td><td>C-13</td></tr> <tr><td>9X</td><td>.....</td><td>E-92</td></tr> <tr><td>AB</td><td>.....</td><td>E-96</td></tr> <tr><td>NX</td><td>.....</td><td>E-105</td></tr> <tr><td>PC</td><td>.....</td><td>C-33</td></tr> <tr><td>PX</td><td>.....</td><td>E-115</td></tr> <tr><td>PX-LPG</td><td>.....</td><td>D-5</td></tr> <tr><td>YX</td><td>.....</td><td>C-45</td></tr> <tr><td>82</td><td>.....</td><td>B-4</td></tr> </table>	54	E-48	55	E-53	56	E-68	91N	C-13	9X	E-92	AB	E-96	NX	E-105	PC	C-33	PX	E-115	PX-LPG	D-5	YX	C-45	82	B-4	<p>C4 Metric female swivel 24°/60°</p> <p>45° elbow – Light series – Metric swivel nut</p>  <table border="0"> <tr><td>54</td><td>.....</td><td>E-48</td></tr> <tr><td>55</td><td>.....</td><td>E-54</td></tr> <tr><td>56</td><td>.....</td><td>E-69</td></tr> <tr><td>82</td><td>.....</td><td>B-5</td></tr> </table>	54	E-48	55	E-54	56	E-69	82	B-5	<p>C5 Metric female swivel 24°/60°</p> <p>90° elbow – Light series – Metric swivel nut</p>  <table border="0"> <tr><td>54</td><td>.....</td><td>E-49</td></tr> <tr><td>55</td><td>.....</td><td>E-54</td></tr> <tr><td>56</td><td>.....</td><td>E-69</td></tr> <tr><td>82</td><td>.....</td><td>B-6</td></tr> </table>	54	E-49	55	E-54	56	E-69	82	B-6									
54	E-48																																																																					
55	E-53																																																																					
56	E-68																																																																					
91N	C-13																																																																					
9X	E-92																																																																					
AB	E-96																																																																					
NX	E-105																																																																					
PC	C-33																																																																					
PX	E-115																																																																					
PX-LPG	D-5																																																																					
YX	C-45																																																																					
82	B-4																																																																					
54	E-48																																																																					
55	E-54																																																																					
56	E-69																																																																					
82	B-5																																																																					
54	E-49																																																																					
55	E-54																																																																					
56	E-69																																																																					
82	B-6																																																																					
<p>C6 Metric female swivel 24°/60°</p> <p>Heavy series – Metric swivel nut</p>  <table border="0"> <tr><td>55</td><td>.....</td><td>E-53</td></tr> <tr><td>56</td><td>.....</td><td>E-68</td></tr> <tr><td>58</td><td>.....</td><td>E-81</td></tr> <tr><td>NX</td><td>.....</td><td>E-105</td></tr> </table>	55	E-53	56	E-68	58	E-81	NX	E-105																																																											
55	E-53																																																																					
56	E-68																																																																					
58	E-81																																																																					
NX	E-105																																																																					
<p>CA Metric female swivel 24° with O-ring</p> <p>Light series – Metric swivel nut – ISO 12151-2</p>  <table border="0"> <tr><td>54</td><td>.....</td><td>E-49</td></tr> <tr><td>55</td><td>.....</td><td>E-55</td></tr> <tr><td>56</td><td>.....</td><td>E-70</td></tr> <tr><td>58</td><td>.....</td><td>E-81</td></tr> <tr><td>EX</td><td>.....</td><td>E-98</td></tr> <tr><td>PC</td><td>.....</td><td>C-34</td></tr> <tr><td>PX</td><td>.....</td><td>E-116</td></tr> <tr><td>YX</td><td>.....</td><td>C-46</td></tr> <tr><td>82</td><td>.....</td><td>B-8</td></tr> </table>	54	E-49	55	E-55	56	E-70	58	E-81	EX	E-98	PC	C-34	PX	E-116	YX	C-46	82	B-8	<p>CE Metric female swivel 24° with O-ring</p> <p>45° elbow – Light series – Metric swivel nut – ISO 12151-2</p>  <table border="0"> <tr><td>54</td><td>.....</td><td>E-50</td></tr> <tr><td>55</td><td>.....</td><td>E-56</td></tr> <tr><td>56</td><td>.....</td><td>E-71</td></tr> <tr><td>58</td><td>.....</td><td>E-82</td></tr> <tr><td>PC</td><td>.....</td><td>C-35</td></tr> <tr><td>PX</td><td>.....</td><td>E-117</td></tr> <tr><td>82</td><td>.....</td><td>B-9</td></tr> </table>	54	E-50	55	E-56	56	E-71	58	E-82	PC	C-35	PX	E-117	82	B-9	<p>CF Metric female swivel 24° with O-ring</p> <p>90° elbow – Light series – Metric swivel nut – ISO 12151-2</p>  <table border="0"> <tr><td>54</td><td>.....</td><td>E-50</td></tr> <tr><td>55</td><td>.....</td><td>E-56</td></tr> <tr><td>56</td><td>.....</td><td>E-72</td></tr> <tr><td>58</td><td>.....</td><td>E-83</td></tr> <tr><td>PC</td><td>.....</td><td>C-36</td></tr> <tr><td>PX</td><td>.....</td><td>E-118</td></tr> <tr><td>82</td><td>.....</td><td>B-9</td></tr> </table>	54	E-50	55	E-56	56	E-72	58	E-83	PC	C-36	PX	E-118	82	B-9
54	E-49																																																																					
55	E-55																																																																					
56	E-70																																																																					
58	E-81																																																																					
EX	E-98																																																																					
PC	C-34																																																																					
PX	E-116																																																																					
YX	C-46																																																																					
82	B-8																																																																					
54	E-50																																																																					
55	E-56																																																																					
56	E-71																																																																					
58	E-82																																																																					
PC	C-35																																																																					
PX	E-117																																																																					
82	B-9																																																																					
54	E-50																																																																					
55	E-56																																																																					
56	E-72																																																																					
58	E-83																																																																					
PC	C-36																																																																					
PX	E-118																																																																					
82	B-9																																																																					
<p>C9 Metric female swivel 24° with O-ring</p> <p>Heavy series – Metric swivel nut – ISO 12151-2</p>  <table border="0"> <tr><td>55</td><td>.....</td><td>E-55</td></tr> <tr><td>56</td><td>.....</td><td>E-70</td></tr> <tr><td>58</td><td>.....</td><td>E-82</td></tr> <tr><td>9X</td><td>.....</td><td>E-92</td></tr> <tr><td>EX</td><td>.....</td><td>E-98</td></tr> <tr><td>NX</td><td>.....</td><td>E-106</td></tr> <tr><td>PC</td><td>.....</td><td>C-34</td></tr> <tr><td>PX</td><td>.....</td><td>E-116</td></tr> <tr><td>YX</td><td>.....</td><td>C-46</td></tr> </table>	55	E-55	56	E-70	58	E-82	9X	E-92	EX	E-98	NX	E-106	PC	C-34	PX	E-116	YX	C-46	<p>0C Metric female swivel 24° with O-ring</p> <p>45° elbow – Heavy series – Metric swivel nut – ISO 12151-2</p>  <table border="0"> <tr><td>56</td><td>.....</td><td>E-71</td></tr> <tr><td>58</td><td>.....</td><td>E-83</td></tr> <tr><td>9X</td><td>.....</td><td>E-93</td></tr> <tr><td>NX</td><td>.....</td><td>E-106</td></tr> <tr><td>PC</td><td>.....</td><td>C-35</td></tr> <tr><td>PX</td><td>.....</td><td>E-117</td></tr> </table>	56	E-71	58	E-83	9X	E-93	NX	E-106	PC	C-35	PX	E-117	<p>1C Metric female swivel 24° with O-ring</p> <p>90° elbow – Heavy series – Metric swivel nut – ISO 12151-2</p>  <table border="0"> <tr><td>56</td><td>.....</td><td>E-72</td></tr> <tr><td>58</td><td>.....</td><td>E-84</td></tr> <tr><td>9X</td><td>.....</td><td>E-93</td></tr> <tr><td>NX</td><td>.....</td><td>E-107</td></tr> <tr><td>PC</td><td>.....</td><td>C-36</td></tr> <tr><td>PX</td><td>.....</td><td>E-118</td></tr> </table>	56	E-72	58	E-84	9X	E-93	NX	E-107	PC	C-36	PX	E-118						
55	E-55																																																																					
56	E-70																																																																					
58	E-82																																																																					
9X	E-92																																																																					
EX	E-98																																																																					
NX	E-106																																																																					
PC	C-34																																																																					
PX	E-116																																																																					
YX	C-46																																																																					
56	E-71																																																																					
58	E-83																																																																					
9X	E-93																																																																					
NX	E-106																																																																					
PC	C-35																																																																					
PX	E-117																																																																					
56	E-72																																																																					
58	E-84																																																																					
9X	E-93																																																																					
NX	E-107																																																																					
PC	C-36																																																																					
PX	E-118																																																																					
<p>5C Metric female swivel 60° cone</p>  <table border="0"> <tr><td>82</td><td>.....</td><td>B-12</td></tr> </table>	82	B-12	<p>6C Metric female swivel 60° cone</p> <p>45° elbow</p>  <table border="0"> <tr><td>82</td><td>.....</td><td>B-12</td></tr> </table>	82	B-12	<p>7C Metric female swivel 60° cone</p> <p>90° elbow</p>  <table border="0"> <tr><td>82</td><td>.....</td><td>B-13</td></tr> </table>	82	B-13																																																												
82	B-12																																																																					
82	B-12																																																																					
82	B-13																																																																					
<p>9B Metric female swivel</p> <p>45° elbow – Light series</p>  <table border="0"> <tr><td>82</td><td>.....</td><td>B-7</td></tr> </table>	82	B-7	<p>9C Metric female swivel</p> <p>90° elbow – Light series</p>  <table border="0"> <tr><td>82</td><td>.....</td><td>B-7</td></tr> </table>	82	B-7																																																																
82	B-7																																																																					
82	B-7																																																																					

Metric DIN fittings

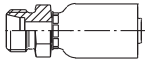
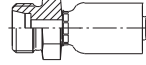
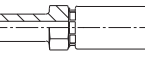
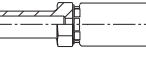
<p>D0 Metric male 24°</p> <p>Light series – ISO 12151-2</p>  <table border="1"> <tr><td>55</td><td>.....</td><td>E-57</td></tr> <tr><td>56</td><td>.....</td><td>E-73</td></tr> <tr><td>58</td><td>.....</td><td>E-84</td></tr> <tr><td>91N</td><td>.....</td><td>C-14</td></tr> <tr><td>PC</td><td>.....</td><td>C-37</td></tr> <tr><td>PX</td><td>.....</td><td>E-119</td></tr> <tr><td>YX</td><td>.....</td><td>C-47</td></tr> <tr><td>82</td><td>.....</td><td>B-10</td></tr> </table>	55	E-57	56	E-73	58	E-84	91N	C-14	PC	C-37	PX	E-119	YX	C-47	82	B-10	<p>D2 Metric male 24°</p> <p>Heavy series – ISO 12151-2</p>  <table border="1"> <tr><td>55</td><td>.....</td><td>E-57</td></tr> <tr><td>56</td><td>.....</td><td>E-73</td></tr> <tr><td>58</td><td>.....</td><td>E-85</td></tr> <tr><td>9X</td><td>.....</td><td>E-84</td></tr> <tr><td>NX</td><td>.....</td><td>E-107</td></tr> <tr><td>PC</td><td>.....</td><td>C-37</td></tr> <tr><td>PX</td><td>.....</td><td>E-119</td></tr> <tr><td>YX</td><td>.....</td><td>C-47</td></tr> </table>	55	E-57	56	E-73	58	E-85	9X	E-84	NX	E-107	PC	C-37	PX	E-119	YX	C-47
55	E-57																																															
56	E-73																																															
58	E-84																																															
91N	C-14																																															
PC	C-37																																															
PX	E-119																																															
YX	C-47																																															
82	B-10																																															
55	E-57																																															
56	E-73																																															
58	E-85																																															
9X	E-84																																															
NX	E-107																																															
PC	C-37																																															
PX	E-119																																															
YX	C-47																																															
<p>1D Metric standpipe</p> <p>Light series</p>  <table border="1"> <tr><td>54</td><td>.....</td><td>E-51</td></tr> <tr><td>55</td><td>.....</td><td>E-58</td></tr> <tr><td>56</td><td>.....</td><td>E-74</td></tr> <tr><td>91N</td><td>.....</td><td>C-15</td></tr> <tr><td>AB</td><td>.....</td><td>E-96</td></tr> <tr><td>EX</td><td>.....</td><td>E-99</td></tr> <tr><td>PC</td><td>.....</td><td>C-38</td></tr> <tr><td>PX</td><td>.....</td><td>E-120</td></tr> <tr><td>PX-LPG</td><td>.....</td><td>D-7</td></tr> <tr><td>YX</td><td>.....</td><td>C-48</td></tr> <tr><td>82</td><td>.....</td><td>B-11</td></tr> </table>	54	E-51	55	E-58	56	E-74	91N	C-15	AB	E-96	EX	E-99	PC	C-38	PX	E-120	PX-LPG	D-7	YX	C-48	82	B-11	<p>3D Metric standpipe</p> <p>Heavy series</p>  <table border="1"> <tr><td>55</td><td>.....</td><td>E-58</td></tr> <tr><td>56</td><td>.....</td><td>E-74</td></tr> <tr><td>91N</td><td>.....</td><td>C-16</td></tr> <tr><td>AB</td><td>.....</td><td>E-97</td></tr> <tr><td>EX</td><td>.....</td><td>E-99</td></tr> </table>	55	E-58	56	E-74	91N	C-16	AB	E-97	EX	E-99
54	E-51																																															
55	E-58																																															
56	E-74																																															
91N	C-15																																															
AB	E-96																																															
EX	E-99																																															
PC	C-38																																															
PX	E-120																																															
PX-LPG	D-7																																															
YX	C-48																																															
82	B-11																																															
55	E-58																																															
56	E-74																																															
91N	C-16																																															
AB	E-97																																															
EX	E-99																																															

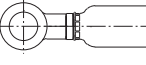
<p>49 Banjo union</p> <p>DIN 7642</p> 	<table border="1"> <tr><td>56</td><td>.....</td><td>E-76</td></tr> <tr><td>EX</td><td>.....</td><td>E-103</td></tr> <tr><td>PX-LPG</td><td>.....</td><td>D-5</td></tr> <tr><td>82</td><td>.....</td><td>B-27</td></tr> </table>	56	E-76	EX	E-103	PX-LPG	D-5	82	B-27
56	E-76											
EX	E-103											
PX-LPG	D-5											
82	B-27											

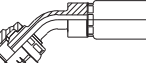

BSP fittings

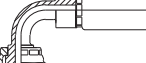
<p>92 BSP female swivel 60° cone</p>  <table border="1"> <tr><td>54</td><td>.....</td><td>E-51</td></tr> <tr><td>55</td><td>.....</td><td>E-59</td></tr> <tr><td>56</td><td>.....</td><td>E-75</td></tr> <tr><td>58</td><td>.....</td><td>E-85</td></tr> <tr><td>91N</td><td>.....</td><td>C-17</td></tr> <tr><td>9X</td><td>.....</td><td>E-94</td></tr> <tr><td>EX</td><td>.....</td><td>E-100</td></tr> <tr><td>NX</td><td>.....</td><td>E-108</td></tr> <tr><td>PC</td><td>.....</td><td>C-38</td></tr> <tr><td>PX</td><td>.....</td><td>E-120</td></tr> <tr><td>YX</td><td>.....</td><td>C-48</td></tr> <tr><td>82</td><td>.....</td><td>B-14</td></tr> </table>	54	E-51	55	E-59	56	E-75	58	E-85	91N	C-17	9X	E-94	EX	E-100	NX	E-108	PC	C-38	PX	E-120	YX	C-48	82	B-14	<p>B1 BSP female swivel 60° cone</p> <p>45° elbow</p>  <table border="1"> <tr><td>54</td><td>.....</td><td>E-52</td></tr> <tr><td>55</td><td>.....</td><td>E-75</td></tr> <tr><td>PC</td><td>.....</td><td>C-39</td></tr> <tr><td>PX</td><td>.....</td><td>E-121</td></tr> <tr><td>YX</td><td>.....</td><td>C-49</td></tr> <tr><td>82</td><td>.....</td><td>B-15</td></tr> </table>	54	E-52	55	E-75	PC	C-39	PX	E-121	YX	C-49	82	B-15
54	E-51																																																					
55	E-59																																																					
56	E-75																																																					
58	E-85																																																					
91N	C-17																																																					
9X	E-94																																																					
EX	E-100																																																					
NX	E-108																																																					
PC	C-38																																																					
PX	E-120																																																					
YX	C-48																																																					
82	B-14																																																					
54	E-52																																																					
55	E-75																																																					
PC	C-39																																																					
PX	E-121																																																					
YX	C-49																																																					
82	B-15																																																					

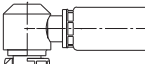
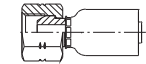
<p>B2 BSP female swivel 60° cone</p> <p>90° elbow</p> 	<table border="1"> <tr><td>54</td><td>.....</td><td>E-52</td></tr> <tr><td>55</td><td>.....</td><td>E-59</td></tr> <tr><td>56</td><td>.....</td><td>E-76</td></tr> <tr><td>58</td><td>.....</td><td>E-86</td></tr> <tr><td>PC</td><td>.....</td><td>C-39</td></tr> <tr><td>PX</td><td>.....</td><td>E-121</td></tr> <tr><td>YX</td><td>.....</td><td>C-49</td></tr> <tr><td>82</td><td>.....</td><td>B-15</td></tr> </table>	54	E-52	55	E-59	56	E-76	58	E-86	PC	C-39	PX	E-121	YX	C-49	82	B-15
54	E-52																							
55	E-59																							
56	E-76																							
58	E-86																							
PC	C-39																							
PX	E-121																							
YX	C-49																							
82	B-15																							

<p>B4 BSP female swivel 60° cone</p> <p>90° compact elbow</p>  <table border="1"> <tr><td>55</td><td>.....</td><td>E-60</td></tr> <tr><td>56</td><td>.....</td><td>E-76</td></tr> <tr><td>PX</td><td>.....</td><td>E-122</td></tr> <tr><td>YX</td><td>.....</td><td>C-50</td></tr> </table>	55	E-60	56	E-76	PX	E-122	YX	C-50	<p>U0 BSP female swivel (ballnose)</p> <p>BSP swivel nut</p>  <table border="1"> <tr><td>NX</td><td>.....</td><td>E-108</td></tr> <tr><td>PC</td><td>.....</td><td>C-40</td></tr> <tr><td>PX</td><td>.....</td><td>E-122</td></tr> <tr><td>PX-LPG</td><td>.....</td><td>D-6</td></tr> <tr><td>YX</td><td>.....</td><td>C-50</td></tr> </table>	NX	E-108	PC	C-40	PX	E-122	PX-LPG	D-6	YX	C-50
55	E-60																										
56	E-76																										
PX	E-122																										
YX	C-50																										
NX	E-108																										
PC	C-40																										
PX	E-122																										
PX-LPG	D-6																										
YX	C-50																										

<p>NM BSP male with ED sealing</p> <p>ISO 1179</p> 	<table border="1"> <tr><td>82</td><td>.....</td><td>B-25</td></tr> </table>	82	B-25
82	B-25		





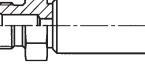
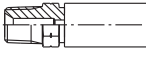



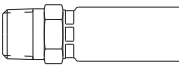
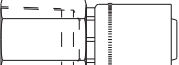
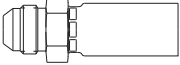

<p>AF BSP male with O-ring sealing</p>  <table border="1"> <tr><td>82</td><td>.....</td><td>B-24</td></tr> </table>	82	B-24	<p>D9 BSP male</p> <p>DIN 3852 Form A</p>  <table border="1"> <tr><td>55</td><td>.....</td><td>E-60</td></tr> <tr><td>56</td><td>.....</td><td>E-77</td></tr> <tr><td>58</td><td>.....</td><td>E-86</td></tr> <tr><td>91N</td><td>.....</td><td>C-17</td></tr> <tr><td>EX</td><td>.....</td><td>E-100</td></tr> <tr><td>PC</td><td>.....</td><td>C-40</td></tr> <tr><td>PX</td><td>.....</td><td>E-123</td></tr> <tr><td>YX</td><td>.....</td><td>C-51</td></tr> <tr><td>Push-Lok®</td><td>.....</td><td>B-16</td></tr> </table>	55	E-60	56	E-77	58	E-86	91N	C-17	EX	E-100	PC	C-40	PX	E-123	YX	C-51	Push-Lok®	B-16
82	B-24																													
55	E-60																													
56	E-77																													
58	E-86																													
91N	C-17																													
EX	E-100																													
PC	C-40																													
PX	E-123																													
YX	C-51																													
Push-Lok®	B-16																													

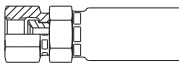
<p>BP BSP female</p> <p>Rigid</p> 	<table border="1"> <tr><td>EX</td><td>.....</td><td>E-101</td></tr> </table>	EX	E-101
EX	E-101		

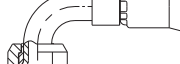
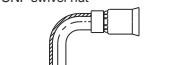

<p>3B BSP male 60° flare</p>  <table border="1"> <tr><td>NX</td><td>.....</td><td>E-109</td></tr> <tr><td>PC</td><td>.....</td><td>C-41</td></tr> <tr><td>PX</td><td>.....</td><td>E-125</td></tr> <tr><td>YX</td><td>.....</td><td>C-51</td></tr> </table>	NX	E-109	PC	C-41	PX	E-125	YX	C-51	<p>91 BSP male taper pipe</p>  <table border="1"> <tr><td>PX</td><td>.....</td><td>E-125</td></tr> <tr><td>82</td><td>.....</td><td>B-17</td></tr> </table>	PX	E-125	82	B-17
NX	E-109																	
PC	C-41																	
PX	E-125																	
YX	C-51																	
PX	E-125																	
82	B-17																	

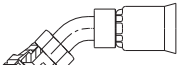
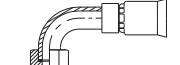
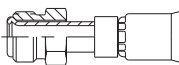
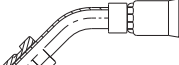
<p>BP BSP female</p> <p>Rigid</p> 	<table border="1"> <tr><td>EX</td><td>.....</td><td>E-101</td></tr> </table>	EX	E-101
EX	E-101		

SAE and JIC fittings

<p>01 National Pipe Tapered (NPT) male</p>  <table border="0"> <tr><td>55</td><td>.....</td><td>E-61</td></tr> <tr><td>57</td><td>.....</td><td>E-80</td></tr> <tr><td>58</td><td>.....</td><td>E-87</td></tr> <tr><td>91N</td><td>.....</td><td>C-18</td></tr> <tr><td>93N</td><td>.....</td><td>C-30</td></tr> <tr><td>EX</td><td>.....</td><td>E-101</td></tr> <tr><td>NX</td><td>.....</td><td>E-109</td></tr> <tr><td>PC</td><td>.....</td><td>C-42</td></tr> <tr><td>PX</td><td>.....</td><td>E-126</td></tr> <tr><td>YX</td><td>.....</td><td>C-52</td></tr> <tr><td>82</td><td>.....</td><td>B-18</td></tr> </table>	55	E-61	57	E-80	58	E-87	91N	C-18	93N	C-30	EX	E-101	NX	E-109	PC	C-42	PX	E-126	YX	C-52	82	B-18	<p>02 National Pipe Tapered (NPT) female</p> <p>Rigid</p>  <table border="0"> <tr><td>93N</td><td>.....</td><td>C-30</td></tr> <tr><td>82</td><td>.....</td><td>B-19</td></tr> </table>	93N	C-30	82	B-19	<p>03 SAE (JIC) 37° male</p>  <table border="0"> <tr><td>55</td><td>.....</td><td>E-62</td></tr> <tr><td>NX</td><td>.....</td><td>E-110</td></tr> <tr><td>PC</td><td>.....</td><td>C-42</td></tr> <tr><td>PX</td><td>.....</td><td>E-126</td></tr> <tr><td>YX</td><td>.....</td><td>C-52</td></tr> <tr><td>82</td><td>.....</td><td>B-20</td></tr> </table>	55	E-62	NX	E-110	PC	C-42	PX	E-126	YX	C-52	82	B-20																					
55	E-61																																																																														
57	E-80																																																																														
58	E-87																																																																														
91N	C-18																																																																														
93N	C-30																																																																														
EX	E-101																																																																														
NX	E-109																																																																														
PC	C-42																																																																														
PX	E-126																																																																														
YX	C-52																																																																														
82	B-18																																																																														
93N	C-30																																																																														
82	B-19																																																																														
55	E-62																																																																														
NX	E-110																																																																														
PC	C-42																																																																														
PX	E-126																																																																														
YX	C-52																																																																														
82	B-20																																																																														
<p>13 National Pipe Tapered (NPT) male swivel</p> <p>SAE (JIC) J476A – J516</p>  <table border="0"> <tr><td>82</td><td>.....</td><td>B-19</td></tr> </table>			82	B-19																																																																											
82	B-19																																																																														
<p>06 SAE (JIC) 37° female swivel</p> <p>UNF swivel nut</p>  <table border="0"> <tr><td>55</td><td>.....</td><td>E-63</td></tr> <tr><td>56</td><td>.....</td><td>E-77</td></tr> <tr><td>57</td><td>.....</td><td>E-80</td></tr> <tr><td>58</td><td>.....</td><td>E-88</td></tr> <tr><td>91N</td><td>.....</td><td>C-19</td></tr> <tr><td>93N</td><td>.....</td><td>C-31</td></tr> <tr><td>9X</td><td>.....</td><td>E-95</td></tr> <tr><td>EX</td><td>.....</td><td>E-102</td></tr> <tr><td>NX</td><td>.....</td><td>E-110</td></tr> <tr><td>PC</td><td>.....</td><td>C-43</td></tr> <tr><td>PX</td><td>.....</td><td>E-127</td></tr> <tr><td>YX</td><td>.....</td><td>C-53</td></tr> <tr><td>82</td><td>.....</td><td>B-21</td></tr> </table>	55	E-63	56	E-77	57	E-80	58	E-88	91N	C-19	93N	C-31	9X	E-95	EX	E-102	NX	E-110	PC	C-43	PX	E-127	YX	C-53	82	B-21	<p>37 SAE (JIC) 37° female swivel</p> <p>45° elbow – UNF swivel nut</p>  <table border="0"> <tr><td>55</td><td>.....</td><td>E-64</td></tr> <tr><td>91N</td><td>.....</td><td>C-20</td></tr> <tr><td>PC</td><td>.....</td><td>C-44</td></tr> <tr><td>PX</td><td>.....</td><td>E-128</td></tr> <tr><td>YX</td><td>.....</td><td>C-54</td></tr> <tr><td>82</td><td>.....</td><td>B-22</td></tr> </table>	55	E-64	91N	C-20	PC	C-44	PX	E-128	YX	C-54	82	B-22	<p>39 SAE (JIC) 37° female swivel</p> <p>90° elbow – UNF swivel nut</p>  <table border="0"> <tr><td>55</td><td>.....</td><td>E-64</td></tr> <tr><td>58</td><td>.....</td><td>E-89</td></tr> <tr><td>91N</td><td>.....</td><td>C-21</td></tr> <tr><td>PC</td><td>.....</td><td>C-44</td></tr> <tr><td>PX</td><td>.....</td><td>E-128</td></tr> <tr><td>YX</td><td>.....</td><td>C-54</td></tr> <tr><td>82</td><td>.....</td><td>B-22</td></tr> </table>	55	E-64	58	E-89	91N	C-21	PC	C-44	PX	E-128	YX	C-54	82	B-22
55	E-63																																																																														
56	E-77																																																																														
57	E-80																																																																														
58	E-88																																																																														
91N	C-19																																																																														
93N	C-31																																																																														
9X	E-95																																																																														
EX	E-102																																																																														
NX	E-110																																																																														
PC	C-43																																																																														
PX	E-127																																																																														
YX	C-53																																																																														
82	B-21																																																																														
55	E-64																																																																														
91N	C-20																																																																														
PC	C-44																																																																														
PX	E-128																																																																														
YX	C-54																																																																														
82	B-22																																																																														
55	E-64																																																																														
58	E-89																																																																														
91N	C-21																																																																														
PC	C-44																																																																														
PX	E-128																																																																														
YX	C-54																																																																														
82	B-22																																																																														
<p>41 SAE (JIC) 37° female swivel</p> <p>90° elbow – Long drop length – UNF swivel nut</p>  <table border="0"> <tr><td>91N</td><td>.....</td><td>C-21</td></tr> </table>	91N	C-21	<p>05 UNF male with O-ring</p>  <table border="0"> <tr><td>55</td><td>.....</td><td>E-62</td></tr> </table>	55	E-62	<p>07 NPSM female swivel</p>  <table border="0"> <tr><td>91N</td><td>.....</td><td>C-20</td></tr> <tr><td>NX</td><td>.....</td><td>E-111</td></tr> <tr><td>PC</td><td>.....</td><td>C-43</td></tr> <tr><td>PX</td><td>.....</td><td>E-127</td></tr> <tr><td>YX</td><td>.....</td><td>C-53</td></tr> </table>	91N	C-20	NX	E-111	PC	C-43	PX	E-127	YX	C-53																																																									
91N	C-21																																																																														
55	E-62																																																																														
91N	C-20																																																																														
NX	E-111																																																																														
PC	C-43																																																																														
PX	E-127																																																																														
YX	C-53																																																																														
<p>08 SAE (JIC) 45° female swivel</p> <p>UNF swivel nut</p>  <table border="0"> <tr><td>91N</td><td>.....</td><td>C-22</td></tr> <tr><td>JJ</td><td>.....</td><td>D-3</td></tr> <tr><td>82</td><td>.....</td><td>B-23</td></tr> </table>	91N	C-22	JJ	D-3	82	B-23	<p>77 SAE (JIC) 45° female swivel</p> <p>45° elbow – UNF swivel nut</p>  <table border="0"> <tr><td>91N</td><td>.....</td><td>C-22</td></tr> </table>	91N	C-22	<p>79 SAE (JIC) 45° female swivel</p> <p>90° elbow – UNF swivel nut</p>  <table border="0"> <tr><td>91N</td><td>.....</td><td>C-23</td></tr> </table>	91N	C-23																																																															
91N	C-22																																																																														
JJ	D-3																																																																														
82	B-23																																																																														
91N	C-22																																																																														
91N	C-23																																																																														
<p>28 SAE (JIC) 45° male swivel</p> <p>UNF male swivel</p>  <table border="0"> <tr><td>91N</td><td>.....</td><td>C-23</td></tr> <tr><td>PX-LPG</td><td>.....</td><td>D-7</td></tr> </table>	91N	C-23	PX-LPG	D-7	<p>67 SAE (JIC) 45° male swivel</p> <p>45° elbow – UNF male swivel</p>  <table border="0"> <tr><td>91N</td><td>.....</td><td>C-24</td></tr> </table>	91N	C-24	<p>69 SAE (JIC) 45° male swivel</p> <p>90° elbow – UNF male swivel</p>  <table border="0"> <tr><td>91N</td><td>.....</td><td>C-24</td></tr> </table>	91N	C-24																																																																		
91N	C-23																																																																														
PX-LPG	D-7																																																																														
91N	C-24																																																																														
91N	C-24																																																																														

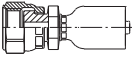
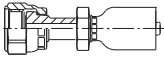
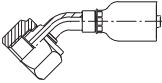
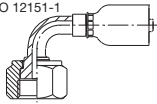
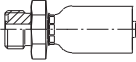
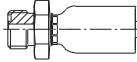
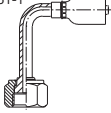
ORFS fittings





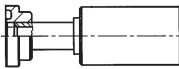
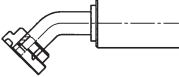
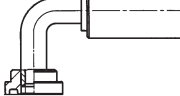
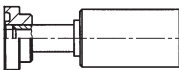
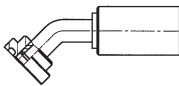
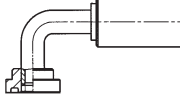

<p>JC O-Lok® ORFS swivel nut</p> <p>Short version – UNF swivel nut ISO 12151-1</p> 	<p>JS O-Lok® ORFS swivel nut</p> <p>Long version – UNF swivel nut ISO 12151-1</p> 
<p>J7 O-Lok® ORFS swivel nut</p> <p>45° elbow – UNF swivel nut ISO 12151-1</p> 	<p>J9 O-Lok® ORFS swivel nut</p> <p>90° elbow – UNF swivel nut ISO 12151-1</p> 
<p>J0 O-Lok® ORFS male</p> <p>ISO 12151-1</p> 	<p>JM O-Lok® ORFS male</p> <p>ISO 12151-1</p> 
<p>J1 O-Lok® ORFS swivel nut</p> <p>90° elbow – Long drop length – UNF swivel nut ISO 12151-1</p> 	<p>J6 O-Lok® ORFS male</p> <p>ISO 12151-1</p> 

Fitting selection

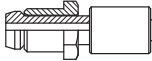

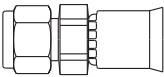
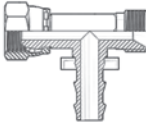
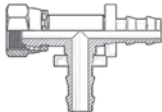
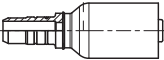
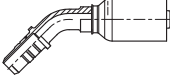
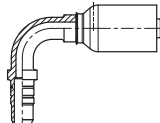
Flanges

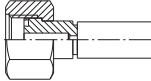
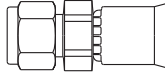
<p>15 SAE (JIC) code 61 flange</p> <p>Standard version – ISO 12151-3</p> 	<p>17 SAE (JIC) code 61 flange</p> <p>45° elbow – Standard version – ISO 12151-3</p> 	<p>19 SAE (JIC) code 61 flange</p> <p>90° elbow – Standard version – ISO 12151-3</p> 
<p>6A SAE (JIC) code 61 flange</p> <p>Heavy series – ISO 12151-3</p> 	<p>6F SAE (JIC) code 61 flange</p> <p>45° elbow – Heavy series – ISO 12151-3</p> 	<p>6N SAE (JIC) code 61 flange</p> <p>90° elbow – Heavy series – ISO 12151-3</p> 

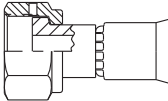
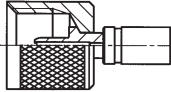
Others

<p>34 Inch sized standpipe</p>  <p>82 B-17</p>	<p>7A LPG 30° male swivel</p>  <p>PX-LPG..... D-6</p>	<p>82 Push-Lok® connector</p>  <p>82 B-28</p>
<p>AL A-Lok® connector with clamp ring</p>  <p>91N C-27</p>	<p>DP Metric female swivel Tee / male stud</p>  <p>82 B-28</p>	<p>DR Metric female swivel Tee / male stud</p>  <p>82 B-29</p>
<p>EN Universal Push to Connect</p>  <p>56 E-78</p>	<p>EU Universal Push to Connect</p> <p>45° elbow</p>  <p>56 E-79</p>	<p>ET Universal Push to Connect</p> <p>90° elbow</p>  <p>56 E-79</p>
<p>FF Metru-Lok female swivel</p>  <p>82 B-24</p>	<p>GA Female gas joint</p> <p>according to NEN 176</p>  <p>PX E-131</p>	<p>P6 CPI® connector with female swivel and clamp ring</p>  <p>91N C-27</p>
<p>PH LPG quick connector</p>  <p>PX-LPG..... D-7</p>	<p>Q1 "Ultra Seal" connector</p> <p>UNF swivel nut</p>  <p>91N C-28</p>	<p>R8 Quick connect fitting with metric swivel nut</p> <p>Knurled</p>  <p>EX E-103</p>

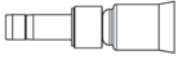
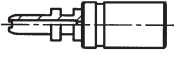
Others

<p>TU A-Lok® tube stub end</p>  <p>91N C-28</p>	<p>YW A-Lok® metric standpipe</p>  <p>91N C-29 82 B-25</p>
<p>YP Quick connect fitting with clip</p>  <p>EX E-104</p>	<p>YR Quick connect fitting with metric swivel nut</p>  <p>EX E-104</p>
<p>VW12 BSP female swivel</p> <p>acc. VW standard 39-V-16 631</p>  <p>82 B-26</p>	

Fitting selection

Fittings cross reference table

Parker end connection code	Fitting series																	
	54	55	56	57	58	91N	93N	9X	AB	EX	JJ	NX	PC	PX	PX-LPG	YX	82*	
01	-	E-61	-	E-80	E-87	C-18	C-30	-	-	E-101	-	E-109	C-42	E-126	-	C-52	B-18	
02	-	-	-	-	-	-	C-30	-	-	-	-	-	-	-	-	B-19	-	
03	-	E-62	-	-	-	-	-	-	-	-	-	E-110	C-42	E-126	-	C-52	B-20	
05	-	E-62	-	-	-	-	-	-	-	-	-	-	-	-	-	-	-	
06	-	E-63	E-77	E-80	E-88	C-19	C-31	E-95	-	E-102	-	E-110	C-43	E-127	-	C-53	B-21	
07	-	-	-	-	-	C-20	-	-	-	-	-	E-111	C-43	E-127	-	C-53	-	
08	-	-	-	-	-	C-22	-	-	-	-	D-3	-	-	-	-	-	B-23	
0C	-	-	E-71	-	E-83	-	-	E-93	-	-	-	E-106	C-35	E-117	-	-	-	
13	-	-	-	-	-	-	-	-	-	-	-	-	-	-	-	-	B-19	
15	-	-	-	-	-	-	-	-	-	-	-	E-111	-	-	-	-	-	
17	-	-	-	-	-	-	-	-	-	-	-	E-112	-	-	-	-	-	
19	-	-	-	-	-	-	-	-	-	-	-	E-112	-	-	-	-	-	
1C	-	-	E-72	-	E-84	-	-	E-93	-	-	-	E-107	C-36	E-118	-	-	-	
1D	E-51	E-58	E-74	-	-	C-15	-	-	E-96	E-99	-	-	C-38	E-120	D-7	C-48	B-11	
28	-	-	-	-	-	C-23	-	-	-	-	-	-	-	-	D-7	-	-	
34	-	-	-	-	-	-	-	-	-	-	-	-	-	-	-	-	B-17	
37	-	E-64	-	-	-	C-20	-	-	-	-	-	-	C-44	E-128	-	C-54	B-22	
39	-	E-64	-	-	E-89	C-21	-	-	-	-	-	-	C-44	E-128	-	C-54	B-22	
3B	-	-	-	-	-	-	-	-	-	-	-	E-109	C-41	E-125	-	C-51	-	
3D	-	E-58	E-74	-	-	C-16	-	-	E-97	E-99	-	-	-	-	-	-	-	
41	-	-	-	-	-	C-21	-	-	-	-	-	-	-	-	-	-	-	
49	-	-	E-78	-	-	-	-	-	-	E-103	-	-	-	-	D-5	-	B-27	
5C	-	-	-	-	-	-	-	-	-	-	-	-	-	-	-	-	B-12	
67	-	-	-	-	-	C-24	-	-	-	-	-	-	-	-	-	-	-	
69	-	-	-	-	-	C-24	-	-	-	-	-	-	-	-	-	-	-	
6A	-	-	-	-	-	-	-	-	-	-	-	E-113	-	-	-	-	-	
6C	-	-	-	-	-	-	-	-	-	-	-	-	-	-	-	-	B-12	
6F	-	-	-	-	-	-	-	-	-	-	-	E-113	-	-	-	-	-	
6N	-	-	-	-	-	-	-	-	-	-	-	E-114	-	-	-	-	-	
77	-	-	-	-	-	C-22	-	-	-	-	-	-	-	-	-	-	-	
79	-	-	-	-	-	C-23	-	-	-	-	-	-	-	-	-	-	-	
7A	-	-	-	-	-	-	-	-	-	-	-	-	-	-	D-6	-	-	

* Push-Lok®

Parker end connection code	Fitting series																
	54	55	56	57	58	91N	93N	9X	AB	EX	NX	PC	PX	PX-LPG	YX	82*	
7C	-	-	-	-	-	-	-	-	-	-	-	-	-	-	-	-	B-13
82	-	-	-	-	-	-	-	-	-	-	-	-	-	-	-	-	B-28
91	-	-	-	-	-	-	-	-	-	-	-	-	E-125	-	-	-	B-17
92	E-51	E-59	E-75	-	E-85	C-17	-	E-94	-	E-100	E-108	C-38	E-120	-	C-48	-	B-14
9B	-	-	-	-	-	-	-	-	-	-	-	-	-	-	-	-	B-7
9C	-	-	-	-	-	-	-	-	-	-	-	-	-	-	-	-	B-7
AF	-	-	-	-	-	-	-	-	-	-	-	-	-	-	-	-	B-24
AL	-	-	-	-	-	C-27	-	-	-	-	-	-	-	-	-	-	-
B1	E-52	-	E-75	-	-	-	-	-	-	-	-	C-39	E-121	-	C-49	-	B-15
B2	E-52	E-59	E-76	-	E-86	-	-	-	-	-	-	C-39	E-121	-	C-49	-	B-15
B4	-	E-60	E-76	-	-	-	-	-	-	-	-	-	E-122	-	C-50	-	-
BP	-	-	-	-	-	-	-	-	-	E-101	-	-	-	-	-	-	-
C3	E-48	E-53	E-68	-	-	C-13	-	E-92	E-96	-	E-105	C-33	E-115	D-5	C-45	-	B-4
C4	E-48	E-54	E-69	-	-	-	-	-	-	-	-	-	-	-	-	-	B-5
C5	E-49	E-54	E-69	-	-	-	-	-	-	-	-	-	-	-	-	-	B-6
C6	-	E-53	E-68	-	E-81	-	-	-	-	-	E-105	-	-	-	-	-	-
C9	-	E-55	E-70	-	E-82	-	-	E-92	-	E-98	E-106	C-34	E-116	-	C-46	-	-
CA	E-49	E-55	E-70	-	E-81	-	-	-	-	E-98	-	C-34	E-116	-	C-46	-	B-8
CE	E-50	E-56	E-71	-	E-82	-	-	-	-	-	-	C-35	E-117	-	-	-	B-9
CF	E-50	E-56	E-72	-	E-83	-	-	-	-	-	-	C-36	E-118	-	-	-	B-9
D0	-	E-57	E-73	-	E-84	C-14	-	-	-	-	-	C-37	E-119	-	C-47	-	B-10
D2	-	E-57	E-73	-	E-85	-	-	E-94	-	-	E-107	C-37	E-119	-	C-47	-	-
D9	-	E-60	E-77	-	E-86	C-17	-	-	-	E-100	-	C-40	E-123	-	C-51	-	B-16
DP	-	-	-	-	-	-	-	-	-	-	-	-	-	-	-	-	B-28
DR	-	-	-	-	-	-	-	-	-	-	-	-	-	-	-	-	B-29
EN	-	-	E-78	-	-	-	-	-	-	-	-	-	-	-	-	-	-
ET	-	-	E-79	-	-	-	-	-	-	-	-	-	-	-	-	-	-
EU	-	-	E-79	-	-	-	-	-	-	-	-	-	-	-	-	-	-
FF	-	-	-	-	-	-	-	-	-	-	-	-	-	-	-	-	B-24
GA	-	-	-	-	-	-	-	-	-	-	-	-	E-131	-	-	-	-
J0	-	E-66	-	-	-	-	-	-	-	-	-	-	-	-	-	-	-
J1	-	E-67	-	-	-	C-26	-	-	-	-	-	-	-	-	-	-	-

* Push-Lok®

Fittings cross reference table

Parker end connection code	Fitting series															
	54	55	56	57	58	91N	93N	9X	AB	EX	NX	PC	PX	PX-LPG	YX	82*
J7	-	E-66	-	-	E-90	C-25	C-32	-	-	-	-	-	-	-	-	-
J9	-	E-67	-	-	E-91	C-26	C-32	-	-	-	-	-	E-131	-	-	-
JC	-	E-65	-	-	E-89	C-25	C-31	-	-	E-102	-	-	E-129	-	-	B-23
JM	-	-	-	-	-	-	-	-	-	-	-	-	E-130	-	-	-
JS	-	E-65	-	-	E-90	-	-	-	-	-	-	-	E-129	-	-	-
NM	-	-	-	-	-	-	-	-	-	-	-	-	-	-	-	B-25
P6	-	-	-	-	-	C-27	-	-	-	-	-	-	-	-	-	-
PH	-	-	-	-	-	-	-	-	-	-	-	-	-	D-7	-	-
Q1	-	-	-	-	-	C-28	-	-	-	-	-	-	-	-	-	-
R8	-	-	-	-	-	-	-	-	-	E-103	-	-	-	-	-	-
TU	-	-	-	-	-	C-28	-	-	-	-	-	-	-	-	-	-
U0	-	-	-	-	-	-	-	-	-	-	E-108	C-40	E-122	D-6	C-50	-
VW121	-	-	-	-	-	-	-	-	-	-	-	-	-	-	-	B-26
YP	-	-	-	-	-	-	-	-	-	E-104	-	-	-	-	-	-
YR	-	-	-	-	-	-	-	-	-	E-104	-	-	-	-	-	-
YW	-	-	-	-	-	C-29	-	-	-	-	-	-	-	-	-	B-25

* Push-Lok®

Chapter B**Push-Lok® hose and fittings****Push-Lok® hose**

830M	– Push-Lok® self-grip hose.....	B-2
838M	– Push-Lok® self-grip hose, electrically non-conductive	B-3

Fittings for Push-Lok® hose

82 series	B-4
-----------------	-----

830M – Push-Lok® self-grip hose

Labs free

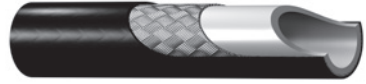

MAIN FEATURES

- **High abrasion resistance**
- **Free of paint effecting substances (labs free)**
(complies with the requirements of the automotive industry)
- Colour variety
- Assembly with Parker Push-Lok® fittings (no additional clamps required)
- **Excellent UV and OZONE resistance**

APPLICATIONS

Factory air systems, many hydraulic applications (fluid compatibility see page A-8 ff.); automotive applications for air, water, lubricating oils and antifreeze fluids.

Not recommended for applications where extreme pulsations are encountered.

CONSTRUCTION

Core tube : Polyurethane
Pressure reinforcement : One layer of high tensile synthetic fibre

Cover : Polyurethane
Colour : black, red, green, blue, grey

TEMPERATURE RANGE

-40°C up to +80°C.

Part No. #	DN size		mm	inch	mm	Max. working pressure		Min. burst pressure		Min. bend radius	Weight	Fittings
	mm	inch				MPa	psi	MPa	psi			
830M-4-xxx-RL	6	-04	6.3	1/4	11.2	1.6	232	6.4	928	30	0.10	82
830M-6-xxx-RL	10	-06	9.5	3/8	15.0	1.6	232	6.4	928	50	0.14	82
830M-8-xxx-RL	12	-08	12.7	1/2	19.1	1.6	232	6.4	928	70	0.18	82
830M-10-xxx-RL	16	-10	16	5/8	23.0	1.6	232	6.4	928	90	0.24	82
830M-12-xxx-RL	20	-12	19	3/4	26.0	1.6	232	6.4	928	110	0.28	82

NOTES

Colour code (xxx):
BLK = black
BLU = blue
GRN = green
GRY = grey
RED = red

Example: 830M-6-GRN-RL

838M – Push-Lok® self-grip hose

Electrically non-conductive / labs free



MAIN FEATURES

- **Electrically non-conductive**
- High abrasion resistance
- Free of paint effecting substances (labs free)
(complies with the requirements of the automotive industry)
- Assembly with Parker Push-Lok® fittings
- Excellent UV and OZONE resistance

APPLICATIONS

Especially for applications where a non-conductive hose is required (min. 5 MΩ/m), e.g. for **non-conductive cooling systems with de-ionised water**; factory air systems; many hydraulic applications (fluid compatibility see page A-8 ff.)

Not recommended for applications where extreme pulsations are encountered.

CONSTRUCTION

Core tube : Polyurethane
Pressure reinforcement : One layer of high tensile synthetic fibre

Cover : Polyurethane
Colour : orange

TEMPERATURE RANGE

-40°C up to +80°C.

Part No. #	DN size				mm	Max. working pressure		Min. burst pressure		Min. bend radius	Weight	Fittings
	mm	inch	mm	inch		MPa	psi	MPa	psi			
838M-4-RL	6	-04	6.3	1/4	11.2	1.6	232	6.4	928	30	0.10	82
838M-6-RL	10	-06	9.5	3/8	15.0	1.6	232	6.4	928	50	0.14	82
838M-8-RL	12	-08	12.7	1/2	19.1	1.6	232	6.4	928	70	0.18	82
838M-10-RL	16	-10	16	5/8	23.0	1.6	232	6.4	928	90	0.24	82
838M-12-RL	20	-12	19	3/4	26.0	1.6	232	6.4	928	110	0.28	82

NOTES

Electrically non-conductive acc. to SAE J517 (less than 50 µA leakage under 250,000 Volts per metre).

3C382 – Metric female swivel 24°/60° Light series

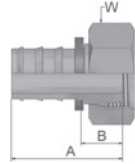

MATERIAL Galvanised steel with transparent Cr(IV)-free plating.
B: Brass; C: Stainless steel; K: without plastic ring.

Part No. #	DN size				Connection type		A mm	B mm	W mm	Max. WP MPa
	mm	inch	Thread size metric	Tube OD mm						
3C382-6-4	6	-4	6.3	1/4	M12x1.5	6	33	14	14	1.6
3C382-6-4B	6	-4	6.3	1/4	M12x1.5	6	33	14	14	1.6
3C382-6-4BK	6	-4	6.3	1/4	M12x1.5	6	33	14	14	1.6
3C382-6-4C	6	-4	6.3	1/4	M12x1.5	6	35	16	14	1.6
3C382-8-4	6	-4	6.3	1/4	M14x1.5	8	33	14	17	1.6
3C382-8-4B	6	-4	6.3	1/4	M14x1.5	8	36	17	19	1.6
3C382-8-4BK	6	-4	6.3	1/4	M14x1.5	8	36	17	19	1.6
3C382-8-4C	6	-4	6.3	1/4	M14x1.5	8	33	14	17	1.6
3C382-10-4	6	-4	6.3	1/4	M16x1.5	10	34	15	19	1.6
3C382-10-4BK	6	-4	6.3	1/4	M16x1.5	10	34	15	19	1.6
3C382-10-4C	6	-4	6.3	1/4	M16x1.5	10	36	17	19	1.6
3C382-10-6	10	-6	9.5	3/8	M16x1.5	10	37	15	19	1.6
3C382-10-6B	10	-6	9.5	3/8	M16x1.5	10	40	17	19	1.6
3C382-10-6BK	10	-6	9.5	3/8	M16x1.5	10	40	17	19	1.6
3C382-10-6C	10	-6	9.5	3/8	M16x1.5	10	40	17	19	1.6
3C382-12-6	10	-6	9.5	3/8	M18x1.5	12	38	16	22	1.6
3C382-12-6BK	10	-6	9.5	3/8	M18x1.5	12	40	17	22	1.6
3C382-12-6C	10	-6	9.5	3/8	M18x1.5	12	38	15	22	1.6
3C382-15-8	12	-8	12.7	1/2	M22x1.5	15	42	15	27	1.6
3C382-15-8B	12	-8	12.7	1/2	M22x1.5	15	46	19	27	1.6
3C382-15-8C	12	-8	12.7	1/2	M22x1.5	15	44	17	27	1.6
3C382-15-8BK	12	-8	12.7	1/2	M22x1.5	15	46	19	27	1.6
3C382-15-10	16	-10	15.9	5/8	M22x1.5	15	56	19	27	1.6
3C382-18-10	16	-10	15.9	5/8	M26x1.5	18	53	17	32	1.6
3C382-18-10C	16	-10	15.9	5/8	M26x1.5	18	54	17	32	1.6
3C382-22-12	20	-12	19.0	3/4	M30x2	22	53	17	36	1.6
3C382-22-12B	20	-12	19.0	3/4	M30x2	22	58	22	36	1.6
3C382-22-12BK	20	-12	19.1	3/4	M30x2	22	58	22	36	1.6
3C382-28-16	25	-16	25.4	1	M36x2	28	58	22	41	1.6
3C382-28-16BK	25	-16	25.4	1	M36x2	28	58	22	41	1.6
3C382-28-16C-K	25	-16	25.4	1	M36x2	28	58	20	41	1.6

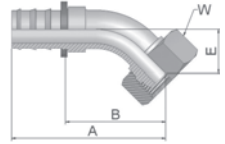
**3C482 – Metric female swivel 24°/60°
45° elbow – Light series**

MATERIAL Galvanised steel with transparent Cr(IV)-free plating.
B: Brass; C: Stainless steel; K: without plastic ring.

Part No. #	DN size				Connection type		A mm	B mm	E mm	W mm	Max. WP MPa
	mm	inch	Thread size metric	Tube OD mm							
3C482-6-4	6	-4	6.3	1/4	M12x1.5	6	51	32	16	14	1.6
3C482-6-4B	6	-4	6.3	1/4	M12x1.5	6	51	32	16	14	1.6
3C482-8-4	6	-4	6.3	1/4	M14x1.5	8	51	32	16	17	1.6
3C482-8-4B	6	-4	6.3	1/4	M14x1.5	8	51	32	16	17	1.6
3C482-8-4C	6	-4	6.3	1/4	M14x1.5	8	49	30	14	17	1.6
3C482-10-6	10	-6	9.5	3/8	M16x1.5	10	58	35	18	19	1.6
3C482-10-6B	10	-6	9.5	3/8	M16x1.5	10	58	35	18	19	1.6
3C482-10-6C	10	-6	9.5	3/8	M16x1.5	10	59	36	19	19	1.6
3C482-12-6	10	-6	9.5	3/8	M18x1.5	12	59	36	18	22	1.6
3C482-12-6B	10	-6	9.5	3/8	M18x1.5	12	59	36	18	22	1.6
3C482-15-8	12	-8	12.7	1/2	M22x1.5	15	68	41	19	27	1.6
3C482-15-8B	12	-8	12.7	1/2	M22x1.5	15	68	41	19	27	1.6
3C482-15-10	16	-10	15.9	5/8	M22x1.5	15	82	45	21	27	1.6
3C482-15-10B	16	-10	15.9	5/8	M22x1.5	15	82	45	21	27	1.6
3C482-18-10	16	-10	15.9	5/8	M26x1.5	18	81	45	21	32	1.6
3C482-18-10B	16	-10	15.9	5/8	M26x1.5	18	81	44	21	32	1.6
3C482-18-12	20	-12	19.1	3/4	M26x1.5	18	99	62	31	32	1.6
3C482-22-12	20	-12	19.1	3/4	M30x2	22	88	52	23	36	1.6
3C482-22-12B	20	-12	19.1	3/4	M30x2	22	88	52	23	36	1.6
3C482-28-16-K	25	-16	25.4	1	M36x2	28	105	67	30	41	1.6

3C582 – Metric female swivel 24°/60° 90° elbow – Light series

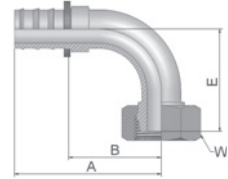

MATERIAL Galvanised steel with transparent Cr(IV)-free plating.
B: Brass; C: Stainless steel; K: without plastic ring.

Part No. #	DN size				Connection type		A mm	B mm	E mm	W mm	Max. WP MPa
	mm	inch	Thread size metric	Tube OD mm							
3C582-6-4	6	-4	6.3	1/4	M12x1.5	6	42	23	29	14	1.6
3C582-6-4B	6	-4	6.3	1/4	M12x1.5	6	42	23	29	14	1.6
3C582-8-4	6	-4	6.3	1/4	M14x1.5	8	42	23	29	17	1.6
3C582-8-4B	6	-4	6.3	1/4	M14x1.5	8	42	23	29	17	1.6
3C582-10-4	6	-4	6.3	1/4	M16x1.5	10	42	23	29	19	1.6
3C582-10-4C	6	-4	6.3	1/4	M16x1.5	10	43	23	31	19	1.6
3C582-10-6	10	-6	9.5	3/8	M16x1.5	10	49	27	33	19	1.6
3C582-10-6B	10	-6	9.5	3/8	M16x1.5	10	49	27	33	19	1.6
3C582-10-6C	10	-6	9.5	3/8	M16x1.5	10	49	27	33	19	1.6
3C582-12-6	10	-6	9.5	3/8	M18x1.5	12	49	27	34	22	1.6
3C582-12-6B	10	-6	9.5	3/8	M18x1.5	12	49	27	34	22	1.6
3C582-12-6C	10	-6	9.5	3/8	M18x1.5	12	49	27	34	22	1.6
3C582-15-8	12	-8	12.7	1/2	M22x1.5	15	60	34	39	27	1.6
3C582-15-8B	12	-8	12.7	1/2	M22x1.5	15	60	34	39	27	1.6
3C582-15-8C	12	-8	12.7	1/2	M22x1.5	15	60	34	39	27	1.6
3C582-18-10	16	-10	15.9	5/8	M26x1.5	18	74	37	43	32	1.6
3C582-22-12	20	-12	19.1	3/4	M30x2	22	88	51	50	36	1.6
3C582-22-12B	20	-12	19.1	3/4	M30x2	22	88	51	50	36	1.6
3C582-22-12C	20	-12	19.1	3/4	M30x2	22	88	51	54	36	1.6
3C582-28-16-K	25	-16	25.4	1	M36x2	28	99	61	70	41	1.6

39B82 – Metric female swivel

45° elbow – Light series

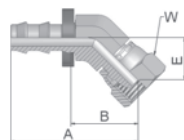

MATERIAL B: Brass; standard version without plastic ring.
When ordering with plastic ring: use Part No. without “K”.

Part No. #	DN size				Connection type		A mm	B mm	E mm	W mm	Max. WP MPa
	mm	inch	Thread size metric	Tube OD mm							
39B82-6-4BK	6	-4	6.3	1/4	M12x1.5	6	44	23	16	14	1.6
39B82-8-4BK	6	-4	6.3	1/4	M14x1.5	8	43	23	15	19	1.6
39B82-10-6BK	10	-6	9.5	3/8	M16x1.5	10	48	25	16	19	1.6
39B82-12-6BK	10	-6	9.5	3/8	M18x1.5	12	50	26	17	22	1.6
39B82-15-8BK	12	-8	12.7	1/2	M22x1.5	15	54	26	18	27	1.6

Push-Lok®

39C82 – Metric female swivel

90° elbow – Light series

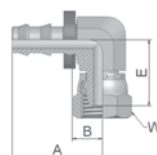

MATERIAL B: Brass; standard version without plastic ring.
When ordering with plastic ring: use Part No. without “K”.

Part No. #	DN size				Connection type		A mm	B mm	E mm	W mm	Max. WP MPa
	mm	inch	Thread size metric	Tube OD mm							
39C82-6-4BK	6	-4	6.3	1/4	M12x1.5	6	30	10	22	14	1.6
39C82-8-4BK	6	-4	6.3	1/4	M14x1.5	8	30	10	22	19	1.6
39C82-10-6BK	10	-6	9.5	3/8	M16x1.5	10	34	10	25	19	1.6
39C82-12-6BK	10	-6	9.5	3/8	M18x1.5	12	34	10	25	22	1.6
39C82-15-8BK	12	-8	12.7	1/2	M22x1.5	15	43	15	32	27	1.6

3CA82 – Metric female swivel 24° with O-ring

Light series – ISO 12151-2-SWS-L – DKOL

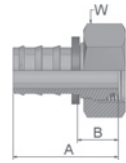

MATERIAL

Galvanised steel with transparent Cr(IV)-free plating.

B: Brass; Fittings with standard O-ring seals can be used for working temperatures from -30 °C up to +105 °C.

Part No. #	DN size				Connection type		A mm	B mm	W mm	Max. WP MPa
	mm	inch	mm	inch	Thread size metric	Tube OD mm				
3CA82-6-4	6	-4	6.3	1/4	M12x1.5	6	40	21	14	1.6
3CA82-6-4B	6	-4	6.3	1/4	M12x1.5	6	40	21	14	1.6
3CA82-8-4	6	-4	6.3	1/4	M14x1.5	8	36	17	17	1.6
3CA82-8-4B	6	-4	6.3	1/4	M14x1.5	8	36	17	17	1.6
3CA82-10-4	6	-4	6.3	1/4	M16x1.5	10	36	17	19	1.6
3CA82-10-6	10	-6	9.5	3/8	M16x1.5	10	40	17	19	1.6
3CA82-10-6B	10	-6	9.5	3/8	M16x1.5	10	40	17	19	1.6
3CA82-12-6	10	-6	9.5	3/8	M18x1.5	12	40	17	22	1.6
3CA82-12-6B	10	-6	9.5	3/8	M18x1.5	12	40	17	22	1.6
3CA82-15-8	12	-8	12.7	1/2	M22x1.5	15	44	18	27	1.6
3CA82-15-8B	12	-8	12.7	1/2	M22x1.5	15	44	18	27	1.6
3CA82-15-10	16	-10	15.9	5/8	M22x1.5	15	60	23	27	1.6
3CA82-15-10B	16	-10	15.9	5/8	M22x1.5	15	60	23	27	1.6
3CA82-18-10	16	-10	15.9	5/8	M26x1.5	18	56	19	32	1.6
3CA82-22-12	20	-12	19.1	3/4	M30x2	22	58	21	36	1.6
3CA82-22-12B	20	-12	19.1	3/4	M30x2	22	58	21	36	1.6

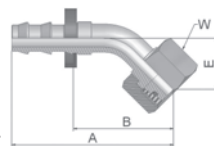
3CE82 – Metric female swivel 24° with O-ring
45° elbow – Light series – ISO 12151-2-SWS45-L – DKOL 45°

MATERIAL Galvanised steel with transparent Cr(IV)-free plating.
B: Brass; Fittings with standard O-ring seals can be used for working temperatures from -30 °C up to +105 °C.

Part No. #	DN size				Connection type		A mm	B mm	E mm	W mm	Max. WP MPa
	mm	inch	Thread size metric	Tube OD mm							
3CE82-6-4	6	-4	6.3	1/4	M12x1.5	6	56	37	21	14	1.6
3CE82-8-4	6	-4	6.3	1/4	M14x1.5	8	51	31	16	17	1.6
3CE82-10-6	10	-6	9.5	3/8	M16x1.5	10	59	37	19	19	1.6
3CE82-12-6	10	-6	9.5	3/8	M18x1.5	12	60	37	19	22	1.6
3CE82-15-8	12	-8	12.7	1/2	M22x1.5	15	69	43	21	27	1.6
3CE82-18-10	16	-10	15.9	5/8	M26x1.5	18	83	46	23	32	1.6
3CE82-22-12	20	-12	19.1	3/4	M30x2	22	97	60	26	36	1.6

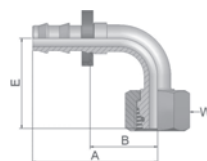
3CF82 – Metric female swivel 24° with O-ring
90° elbow – Light series – ISO 12151-2-SWS-L – DKOL 90°

MATERIAL Brass nipple, galvanised steel swivel nut.
Fittings with standard O-ring seals can be used for working temperatures from -30 °C up to +105 °C.

Part No. #	DN size				Connection type		A mm	B mm	E mm	W mm	Max. WP MPa
	mm	inch	Thread size metric	Tube OD mm							
3CF82-6-4	6	-4	6.3	1/4	M12x1.5	6	42	23	36	14	1.6
3CF82-8-4	6	-4	6.3	1/4	M14x1.5	8	42	23	32	17	1.6
3CF82-10-4	6	-4	6.3	1/4	M16x1.5	10	42	23	31	19	1.6
3CF82-10-6	10	-6	9.5	3/8	M16x1.5	10	49	27	35	19	1.6
3CF82-10-6B	10	-6	9.5	3/8	M16x1.5	10	49	27	35	19	1.6
3CF82-12-6	10	-6	9.5	3/8	M18x1.5	12	49	27	36	22	1.6
3CF82-12-6B	10	-6	9.5	3/8	M18x1.5	12	49	27	36	22	1.6
3CF82-15-8	12	-8	12.7	1/2	M22x1.5	15	58	32	41	27	1.6
3CF82-18-10	16	-10	15.9	5/8	M26x1.5	18	74	37	45	32	1.6
3CF82-22-12	20	-12	19.1	3/4	M30x2	22	88	51	55	36	1.6

3D082 – Metric male 24°

Light series – ISO 12151-2-S-L – CEL

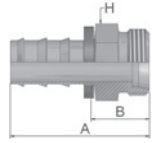

MATERIAL Galvanised steel with transparent Cr(IV)-free plating.
 B: Brass; C: Stainless steel; K: without plastic ring.

Part No. #	DN size				Connection type		A mm	B mm	H mm	Max. WP MPa
	mm	inch	Thread size metric	Tube OD mm						
3D082-6-4	6	-4	6.3	1/4	M12x1.5	6	35	16	12	1.6
3D082-8-4	6	-4	6.3	1/4	M14x1.5	8	36	17	14	1.6
3D082-10-6	10	-6	9.5	3/8	M16x1.5	10	41	18	17	1.6
3D082-10-6B	10	-6	9.5	3/8	M16x1.5	10	41	18	17	1.6
3D082-10-6C	10	-6	9.5	3/8	M16x1.5	10	41	18	17	1.6
3D082-12-6	10	-6	9.5	3/8	M18x1.5	12	41	18	19	1.6
3D082-12-6B	10	-6	9.5	3/8	M18x1.5	12	41	18	19	1.6
3D082-12-6C	10	-6	9.5	3/8	M18x1.5	12	41	18	19	1.6
3D082-15-8	12	-8	12.7	1/2	M22x1.5	15	49	23	22	1.6
3D082-15-8B	12	-8	12.7	1/2	M22x1.5	15	49	23	22	1.6
3D082-15-8BK	12	-8	12.7	1/2	M22x1.5	15	49	22	22	1.6
3D082-15-8C	12	-8	12.7	1/2	M22x1.5	15	49	22	22	1.6
3D082-18-8	12	-8	12.7	1/2	M26x1.5	18	48	21	27	1.6
3D082-18-10	16	-10	15.9	5/8	M26x1.5	18	58	21	27	1.6
3D082-22-12	20	-12	19.1	3/4	M30x2	22	63	27	30	1.6
3D082-22-12B	20	-12	19.1	3/4	M30x2	22	63	27	30	1.6

31D82 – Metric standpipe

Light series – ISO 8434-1 – BEL

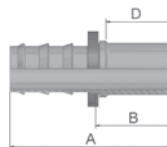

MATERIAL Galvanised steel with transparent Cr(IV)-free plating.
B: Brass; C: Stainless steel; K: without plastic ring.

Part No. #	DN	size		Tube OD mm	A mm	B mm	D mm	Max. WP MPa	
		mm	inch						
31D82-6-4	6	-4	6.3	1/4	6	44	25	22	1.6
31D82-6-4B	6	-4	6.3	1/4	6	44	25	22	1.6
31D82-8-4	6	-4	6.3	1/4	8	44	25	22	1.6
31D82-8-4B	6	-4	6.3	1/4	8	44	25	22	1.6
31D82-10-6	10	-6	9.5	3/8	10	49	26	23	1.6
31D82-10-6B	10	-6	9.5	3/8	10	49	26	23	1.6
31D82-10-6C	10	-6	9.5	3/8	10	49	26	23	1.6
31D82-12-6	10	-6	9.5	3/8	12	49	27	23	1.6
31D82-12-6B	10	-6	9.5	3/8	12	49	27	23	1.6
31D82-12-6C	10	-6	9.5	3/8	12	49	27	23	1.6
31D82-15-8	12	-8	12.7	1/2	15	55	29	25	1.6
31D82-15-8B	12	-8	12.7	1/2	15	55	29	25	1.6
31D82-15-8C	12	-8	12.7	1/2	15	55	29	25	1.6
31D82-18-10	16	-10	15.9	5/8	18	67	30	26	1.6
31D82-18-10B	16	-10	15.9	5/8	18	67	30	26	1.6
31D82-22-12	20	-12	19.1	3/4	22	69	32	28	1.6
31D82-22-12B	20	-12	19.1	3/4	22	69	32	28	1.6

CAUTION For assembly of progressive ring or cutting ring use the pre-assembly body.

35C82 – Metric female swivel 60° cone

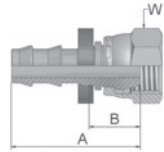

MATERIAL B: Brass; K: without plastic ring.

Part No. #	DN	size		Thread size metric	A mm	B mm	W mm	Max. WP MPa	
		mm	inch						
35C82-12x1-4BK	6	-4	6.3	1/4	M12x1	33	13	14	1.6
35C82-6-4BK	6	-4	6.3	1/4	M12x1.5	33	14	14	1.6
35C82-10-6BK	10	-6	9.5	3/8	M16x1.5	38	15	19	1.6
35C82-10-6B	10	-6	9.5	3/8	M16x1.5	38	15	19	1.6
35C82-15-8BK	12	-8	12.7	1/2	M22x1.5	44	18	27	1.6
35C82-15-8B	12	-8	12.7	1/2	M22x1.5	44	18	27	1.6
35C82-18-10BK	16	-10	15.9	5/8	M26x1.5	56	18	32	1.6

36C82 – Metric female swivel 60° cone 45° elbow

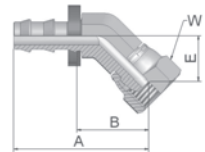

MATERIAL B: Brass; K: without plastic ring.

Part No. #	DN	size		Thread size metric	A mm	B mm	E mm	W mm	Max. WP MPa	
		mm	inch							
36C82-12x1-4BK	6	-4	6.3	1/4	M12x1	43	22	15	14	1.6
36C82-6-4BK	6	-4	6.3	1/4	M12x1.5	44	25	16	14	1.6
36C82-6-4B	6	-4	6.3	1/4	M12x1.5	44	25	16	14	1.6
36C82-10-6BK	10	-6	9.5	3/8	M16x1.5	48	26	16	19	1.6
36C82-10-6B	10	-6	9.5	3/8	M16x1.5	48	26	16	19	1.6
36C82-15-8BK	12	-8	12.7	1/2	M22x1.5	54	28	18	27	1.6

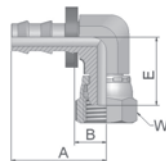
**37C82 – Metric female swivel 60° cone
90° elbow****MATERIAL** B: Brass; K: without plastic ring.

Part No. #	DN	size		Thread size metric	A mm	B mm	E mm	W mm	Max. WP MPa	
		mm	inch							
37C82-12x1-4BK	6	-4	6.3	1/4	M12x1	30	10	22	14	1.6
37C82-12x1-4B	6	-4	6.3	1/4	M12x1	30	10	22	14	1.6
37C82-6-4BK	6	-4	6.3	1/4	M12x1.5	30	11	22	14	1.6
37C82-6-4B	6	-4	6.3	1/4	M12x1.5	30	11	22	14	1.6
37C82-10-6BK	10	-6	9.5	3/8	M16x1.5	34	11	25	19	1.6
37C82-10-6B	10	-6	9.5	3/8	M16x1.5	34	11	25	19	1.6
37C82-15-8BK	12	-8	12.7	1/2	M22x1.5	43	16	32	27	1.6
37C82-15-8B	12	-8	12.7	1/2	M22x1.5	43	16	32	27	1.6

39282 – BSP female swivel 60° cone BS5200-A – DKR

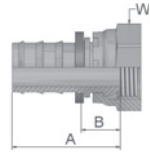

MATERIAL Galvanised steel with transparent Cr(IV)-free plating.
B: Brass; C: Stainless steel.

Part No. #	DN size				Thread size BSP	A mm	B mm	W mm	Max. WP MPa
	mm	inch	mm	inch					
39282-4-4	6	-4	6.3	1/4	1/4x19	33	14	17	1.6
39282-4-4B	6	-4	6.3	1/4	1/4x19	33	14	17	1.6
39282-4-4C	6	-4	6.3	1/4	1/4x19	33	14	19	1.6
39282-6-4B	6	-4	6.3	1/4	3/8x19	37	18	22	1.6
39282-6-6	10	-6	9.5	3/8	3/8x19	37	14	19	1.6
39282-6-6B	10	-6	9.5	3/8	3/8x19	37	14	19	1.6
39282-6-6C	10	-6	9.5	3/8	3/8x19	40	17	22	1.6
39282-8-8	12	-8	12.7	1/2	1/2x14	42	15	27	1.6
39282-8-8B	12	-8	12.7	1/2	1/2x14	42	15	27	1.6
39282-8-8C	12	-8	12.7	1/2	1/2x14	43	16	27	1.6
39282-10-10	16	-10	15.9	5/8	5/8x14	53	16	30	1.6
39282-10-10B	16	-10	15.9	5/8	5/8x14	55	18	30	1.6
39282-12-10C	16	-10	15.9	5/8	3/4x14	55	18	32	1.6
39282-12-12	20	-12	19.0	3/4	3/4x14	58	21	32	1.6
39282-12-12B	20	-12	19.0	3/4	3/4x14	58	21	32	1.6
39282-16-16	25	-16	25.4	1	1x11	57	20	41	1.6

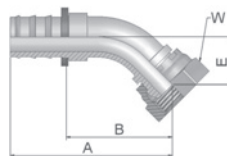
3B182 – BSP female swivel 60° cone
45° elbow – BS5200-D – DKR 45°

MATERIAL Galvanised steel with transparent Cr(IV)-free plating.
B: Brass; C: Stainless steel.

Part No. #	DN	size	mm	inch	Thread size BSP	A mm	B mm	E mm	W mm	Max. WP MPa
3B182-4-4	6	-4	6.3	1/4	1/4x19	51	32	16	17	1.6
3B182-6-6	10	-6	9.5	3/8	3/8x19	58	35	18	19	1.6
3B182-6-6B	10	-6	9.5	3/8	3/8x19	69	46	17	19	1.6
3B182-8-8	12	-8	12.7	1/2	1/2x14	68	41	19	27	1.6
3B182-8-8B	12	-8	12.7	1/2	1/2x14	68	41	19	27	1.6
3B182-10-10	16	-10	15.9	5/8	5/8x14	81	45	21	30	1.6
3B182-12-12	20	-12	19.0	3/4	3/4x14	92	55	27	32	1.6
3B182-16-16-K	25	-16	25.4	1	1x11	106	68	31	41	1.6

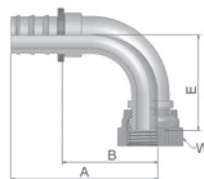
3B282 – BSP female swivel 60° cone
90° elbow – BS5200-B – DKR 90°

MATERIAL Galvanised steel with transparent Cr(IV)-free plating.
B: Brass; C: Stainless steel.

Part No. #	DN	size	mm	inch	Thread size BSP	A mm	B mm	E mm	W mm	Max. WP MPa
3B282-4-4	6	-4	6.3	1/4	1/4x19	42	23	29	17	1.6
3B282-4-4B	6	-4	6.3	1/4	1/4x19	42	23	29	17	1.6
3B282-6-6	10	-6	9.5	3/8	3/8x19	49	27	33	19	1.6
3B282-6-6B	10	-6	9.5	3/8	3/8x19	49	27	33	19	1.6
3B282-8-8	12	-8	12.7	1/2	1/2x14	60	34	39	27	1.6
3B282-8-8B	12	-8	12.7	1/2	1/2x14	60	34	39	27	1.6
3B282-10-8	12	-8	12.7	1/2	5/8x14	58	32	40	30	1.6
3B282-10-10	16	-10	15.9	5/8	5/8x14	74	37	43	30	1.6
3B282-10-10B	16	-10	15.9	5/8	5/8x14	74	37	44	30	1.6
3B282-12-12	20	-12	19.1	3/4	3/4x14	88	51	53	32	1.6
3B282-12-12B	20	-12	19.1	3/4	3/4x14	88	51	53	32	1.6
3B282-16-16-K	25	-16	25.4	1	1x11	99	61	68	41	1.6

3D982 – BSP male BS5200 – AGR

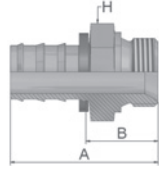

MATERIAL Galvanised steel with transparent Cr(IV)-free plating.
B: Brass

Part No. #	DN size				Thread size BSP	A mm	B mm	H mm	Max. WP MPa
	mm	inch	mm	inch					
3D982-2-4	6	-4	6.3	1/4	1/8x28	36	17	14	1.6
3D982-4-4	6	-4	6.3	1/4	1/4x19	41	23	19	1.6
3D982-4-4B	6	-4	6.3	1/4	1/4x19	41	23	19	1.6
3D982-4-6	10	-6	9.5	3/8	1/4x19	44	21	19	1.6
3D982-4-6B	10	-6	9.5	3/8	1/4x19	44	21	19	1.6
3D982-6-6	10	-6	9.5	3/8	3/8x19	45	23	22	1.6
3D982-6-6B	10	-6	9.5	3/8	3/8x19	45	23	22	1.6
3D982-8-8	12	-8	12.7	1/2	1/2x14	53	27	27	1.6
3D982-8-8B	12	-8	12.7	1/2	1/2x14	53	27	27	1.6
3D982-10-10	16	-10	15.9	5/8	5/8x14	65	28	30	1.6
3D982-10-10B	16	-10	15.9	5/8	5/8x14	65	28	30	1.6
3D982-12-12	20	-12	19.1	3/4	3/4x14	65	28	32	1.6
3D982-12-12B	20	-12	19.1	3/4	3/4x14	65	28	32	1.6

39182 – BSP male taper pipe

BS5200 – AGR-K

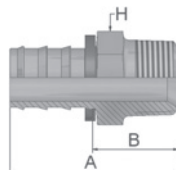

MATERIAL Galvanised steel with transparent Cr(IV)-free plating.
B: Brass

Part No. #	DN size				Thread size BSP	A mm	B mm	H mm	Max. WP MPa
	mm	inch	mm	inch					
39182-2-4B	6	-4	6.3	1/4	1/8x28	37	18	12	1.6
39182-2-4	6	-4	6.3	1/4	1/8x28	37	18	12	1.6
39182-4-4	6	-4	6.3	1/4	1/4x19	40	21	14	1.6
39182-4-4B	6	-4	6.3	1/4	1/4x19	40	21	14	1.6
39182-4-6	10	-6	9.5	3/8	1/4x19	44	21	14	1.6
39182-4-6B	10	-6	9.5	3/8	1/4x19	44	21	14	1.6
39182-6-6	10	-6	9.5	3/8	3/8x19	45	22	19	1.6
39182-6-6B	10	-6	9.5	3/8	3/8x19	45	22	19	1.6
39182-6-8B	12	-8	12.7	1/2	3/8x19	49	22	19	1.6
39182-8-8	12	-8	12.7	1/2	1/2x14	55	29	22	1.6
39182-8-8B	12	-8	12.7	1/2	1/2x14	55	29	22	1.6
39182-8-10B	16	-10	15.9	5/8	1/2x14	65	28	22	1.6
39182-12-10B	16	-10	15.9	5/8	3/4x14	68	31	27	1.6
39182-12-12	20	-12	19.1	3/4	3/4x14	68	31	27	1.6
39182-12-12B	20	-12	19.1	3/4	3/4x14	68	31	27	1.6
39182-16-16B	25	-16	25.4	1	1x11	74	38	36	1.6

33482 – Inch sized standpipe

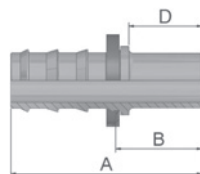

MATERIAL B: Brass

Part No. #	DN size				Tube OD mm	A mm	B mm	D mm	Max. WP MPa
	mm	inch	mm	inch					
33482-4-4B	6	-4	6.3	1/4	1/4	48	29	26	1.6
33482-6-6B	10	-6	9.5	3/8	3/8	57	34	31	1.6
33482-8-8B	12	-8	12.7	1/2	1/2	55	28	25	1.6
33482-10-10B	16	-10	15.9	5/8	5/8	67	30	25	1.6
33482-12-12B	20	-12	19.1	3/4	3/4	67	30	25	1.6

30182 – National Pipe Tapered (NPT) male SAE J476A – J516

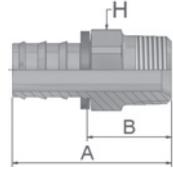

MATERIAL Galvanised steel with transparent Cr(IV)-free plating.
B: Brass; C: Stainless steel; SM: Metric wrench size

Part No. #	DN size				Thread size NPTF	A mm	B mm	H inch	Max. WP MPa
	mm	inch	mm	inch					
30182-2-4	6	-4	6.3	1/4	1/8x27	35	16	7/16	1.6
30182-2-4B	6	-4	6.3	1/4	1/8x27	35	16	7/16	1.6
30182-2-4-SM	6	-4	6.3	1/4	1/8x27	35	16	12 mm	1.6
30182-4-4	6	-4	6.3	1/4	1/4x18	40	21	9/16	1.6
30182-4-4-SM	6	-4	6.3	1/4	1/4x18	40	21	14 mm	1.6
30182-4-4B	6	-4	6.3	1/4	1/4x18	40	21	9/16	1.6
30182-4-4C	6	-4	6.3	1/4	1/4x18	40	21	9/16	1.6
30182-8-4C	6	-4	6.3	1/4	1/2x14	48	29	7/8	1.6
30182-4-6	10	-6	9.5	3/8	1/4x18	45	22	9/16	1.6
30182-4-6B	10	-6	9.5	3/8	1/4x18	45	22	9/16	1.6
30182-4-6-SM	10	-6	9.5	3/8	1/4x18	45	22	14 mm	1.6
30182-6-6	10	-6	9.5	3/8	3/8x18	45	22	11/16	1.6
30182-6-6B	10	-6	9.5	3/8	3/8x18	45	22	11/16	1.6
30182-6-6-SM	10	-6	9.5	3/8	3/8x18	45	22	22 mm	1.6
30182-6-6C	10	-6	9.5	3/8	3/8x18	45	23	11/16	1.6
30182-8-6-SM	10	-6	9.5	3/8	1/2x14	52	29	22 mm	1.6
30182-8-6B-SM	10	-6	9.5	3/8	1/2x14	52	29	22 mm	1.6
30182-6-8	12	-8	12.7	1/2	3/8x18	49	22	11/16	1.6
30182-6-8B	12	-8	12.7	1/2	3/8x18	49	22	11/16	1.6
30182-8-8	12	-8	12.7	1/2	1/2x14	55	29	7/8	1.6
30182-8-8B	12	-8	12.7	1/2	1/2x14	55	29	7/8	1.6
30182-8-8B-SM	12	-8	12.7	1/2	1/2x14	55	29	22 mm	1.6
30182-8-8C	12	-8	12.7	1/2	1/2x14	55	29	7/8	1.6
30182-8-10-SM	16	-10	15.9	5/8	1/2x14	66	29	22 mm	1.6
30182-8-10B	16	-10	15.9	5/8	1/2x14	66	29	7/8	1.6
30182-8-12-SM	20	-12	19.1	3/4	1/2x14	66	29	22 mm	1.6
30182-8-12B	20	-12	19.1	3/4	1/2x14	66	29	7/8	1.6
30182-12-12	20	-12	19.1	3/4	3/4x14	66	29	1-1/16	1.6
30182-12-12C	20	-12	19.1	3/4	3/4x14	66	29	1-1/16	1.6
30182-12-12B	20	-12	19.1	3/4	3/4x14	66	29	1-1/16	1.6

31382 – National Pipe Tapered (NPT) male swivel

SAE J476A – J516

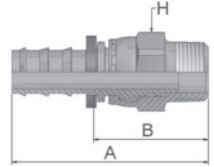

MATERIAL Galvanised steel with transparent Cr(IV)-free plating.

Part No. #	DN size				Thread size NPTF	A mm	B mm	H inch	Max. WP MPa
	mm	inch	mm	inch					
31382-4-4	6	-4	6.3	1/4	1/4x18	41	22	9/16	1.6
31382-4-6	10	-6	9.5	3/8	1/4x18	45	23	11/16	1.6
31382-6-6	10	-6	9.5	3/8	3/8x18	45	23	11/16	1.6
31382-8-8	12	-8	12.7	1/2	1/2x14	56	29	7/8	1.6
31382-12-12	20	-12	19.1	3/4	3/4x14	94	58	1-1/4	1.6

NOTE This fitting allows for minor movement under pressure to relieve the torsion on hose, but it is not to be used for continuous or extreme swiveling. Internal O-ring is not compatible with phosphate ester fluids.

30282 – National Pipe Tapered (NPT) female

Straight – SAE J476A – J516

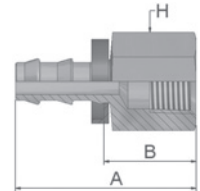

MATERIAL Galvanised steel with transparent Cr(IV)-free plating.
B: Brass; C: Stainless steel; K: without plastic ring;
SM: Metric wrench size

Part No. #	DN size				Thread size NPTF	A mm	B mm	H inch	Max. WP MPa
	mm	inch	mm	inch					
30282-4-4B	6	-4	6.3	1/4	1/4x18	40	21	3/4	1.6
30282-4-4C-SM	6	-4	6.3	1/4	1/4x18	40	21	19 mm	1.6
30282-6-6B	10	-6	9.5	3/8	3/8x18	46	23	7/8	1.6
30282-8-8C	12	-8	12.7	1/2	1/2x14	55	28	1-1/16	1.6
30282-8-8B	12	-8	12.7	1/2	1/2x14	55	28	1-1/16	1.6

30382 – SAE (JIC) 37° male ISO 12151-5-S – AGJ

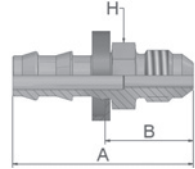

MATERIAL Galvanised steel with transparent Cr(IV)-free plating.
B: Brass

Part No. #	DN size				Thread size UNF	A mm	B mm	H inch	Max. WP MPa
	mm	inch	mm	inch					
30382-4-4	6	-4	6.3	1/4	7/16x20	40	21	1/2	1.6
30382-4-4B	6	-4	6.3	1/4	7/16x20	40	21	1/2	1.6
30382-6-6	10	-6	9.5	3/8	9/16x18	45	22	5/8	1.6
30382-6-6B	10	-6	9.5	3/8	9/16x18	45	22	5/8	1.6
30382-8-8	12	-8	12.7	1/2	3/4x16	52	26	3/4	1.6
30382-8-8B	12	-8	12.7	1/2	3/4x16	52	26	3/4	1.6
30382-12-12	20	-12	19.1	3/4	1-1/16x12	69	32	1-1/8	1.6
30382-12-12B	20	-12	19.1	3/4	1-1/16x12	69	32	1-1/8	1.6

30682/36882 – SAE (JIC) 37° female swivel ISO 12151-5-SWES – DKJ 90°

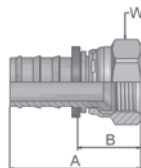

MATERIAL Galvanised steel with transparent Cr(IV)-free plating.
C: Stainless steel; SM: Metric wrench size

Part No. #	DN size				Thread size UNF	A mm	B mm	W inch	Max. WP MPa
	mm	inch	mm	inch					
30682-4-4	6	-4	6.3	1/4	7/16x20	39	19	9/16	1.6
30682-4-4-SM	6	-4	6.3	1/4	7/16x20	40	21	14 mm	1.6
30682-4-4B	6	-4	6.3	1/4	7/16x20	39	19	9/16	1.6
30682-4-4C	6	-4	6.3	1/4	7/16x20	39	19	9/16	1.6
30682-5-4	6	-4	6.3	1/4	1/2x20	40	21	5/8	1.6
30682-5-4B	6	-4	6.3	1/4	1/2x20	40	21	5/8	1.6
36882-5-4C-SM	6	-4	6.3	1/4	1/2x20	40	21	17 mm	1.6
30682-6-4B	6	-4	6.3	1/4	9/16x18	42	22	11/16	1.6
30682-5-6B	10	-6	9.5	3/8	1/2x20	44	21	5/8	1.6
30682-6-6	10	-6	9.5	3/8	9/16x18	46	22	11/16	1.6
30682-6-6-SM	10	-6	9.5	3/8	9/16x18	45	22	19 mm	1.6
30682-6-6B-SM	10	-6	9.5	3/8	9/16x18	45	22	19 mm	1.6
30682-6-6C	10	-6	9.5	3/8	9/16x18	46	22	11/16	1.6
30682-6-6C-SM	10	-6	9.5	3/8	9/16x18	45	22	19 mm	1.6
30682-8-6B	10	-6	9.5	3/8	3/4x16	47	24	7/8	1.6
36882-8-6-SM	10	-6	9.5	3/8	3/4x16	48	25	22 mm	1.6
36882-8-6C-SM	10	-6	9.5	3/8	3/4x16	48	25	22 mm	1.6
30682-8-8	12	-8	12.7	1/2	3/4x16	51	25	7/8	1.6
30682-8-8B	12	-8	12.7	1/2	3/4x16	51	25	7/8	1.6
30682-10-8B	12	-8	12.7	1/2	7/8x14	52	25	1	1.6
30682-10-8-SM	12	-8	12.7	1/2	7/8x14	65	28	27 mm	1.6
30682-10-10	16	-10	15.9	5/8	7/8x14	52	25	1	1.6
30682-10-10-SM	16	-10	15.9	5/8	7/8x14	65	28	27 mm	1.6
30682-10-10B	16	-10	15.9	5/8	7/8x14	62	25	1	1.6
36882-10-10C-SM	16	-10	15.9	5/8	7/8x14	65	28	27 mm	1.6
30682-12-12	20	-12	19.1	3/4	1-1/16x12	67	30	1-1/4	1.6
30682-12-12-SM	20	-12	19.1	3/4	1-1/16x12	67	30	32 mm	1.6
30682-12-12B	20	-12	19.1	3/4	1-1/16x12	67	30	1-1/4	1.6
30682-12-12B-SM	20	-12	19.1	3/4	1-1/16x12	67	30	32 mm	1.6
30682-12-12C	20	-12	19.1	3/4	1-1/16x12	67	30	1-1/4	1.6
30682-12-12C-SM	20	-12	19.1	3/4	1-1/16x12	67	30	32 mm	1.6
30682-16-16-SM	25	-16	25.4	1	1-5/16x12	70	33	41 mm	1.6
30682-16-16C-SM	25	-16	25.4	1	1-5/16x12	70	33	41 mm	1.6

33782/33V82 – SAE (JIC) 37° female swivel 45° elbow – ISO 12151-5-SWE45 – DKJ 45°

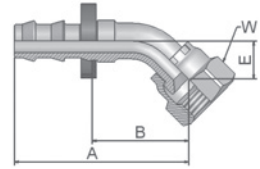

MATERIAL Galvanised steel with transparent Cr(IV)-free plating.
B: Brass; SM: Metric wrench size

Part No. #	DN size				Thread size UNF	A mm	B mm	E mm	W inch	Max. WP MPa
	mm	inch	mm	inch						
33782-4-4	6	-4	6.3	1/4	7/16x20	39	20	8	9/16	1.6
33V82-4-4B-SM	6	-4	6.3	1/4	7/16x20	44	25	10	17 mm	1.6
33782-6-6	10	-6	9.5	3/8	9/16x18	53	30	10	11/16	1.6
33782-6-6-SM	10	-6	9.5	3/8	9/16x18	51	28	11	19 mm	1.6
33782-8-8	12	-8	12.7	1/2	3/4x16	54	35	14	7/8	1.6

33982/33W82 – SAE (JIC) 37° female swivel 90° elbow – ISO 12151-5-SWES – DKJ 90°

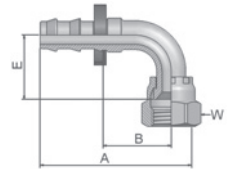

MATERIAL Galvanised steel with transparent Cr(IV)-free plating.
C: Stainless steel; SM: Metric wrench size

Part No. #	DN size				Thread size UNF	A mm	B mm	E mm	W inch	Max. WP MPa
	mm	inch	mm	inch						
33982-4-4	6	-4	6.3	1/4	7/16x20	39	20	17	5/8	1.6
33W82-4-4C-SM	6	-4	6.3	1/4	7/16x20	39	20	21	17 mm	1.6
33982-6-6	10	-6	9.5	3/8	9/16x18	50	28	22	11/16	1.6
33982-6-6-SM	10	-6	9.5	3/8	9/16x18	47	25	23	19 mm	1.6
33982-6-6C-SM	10	-6	9.5	3/8	9/16x18	47	25	23	19 mm	1.6
33982-8-8	12	-8	12.7	1/2	3/4x16	59	33	28	7/8	1.6
33W82-8-8-SM	12	-8	12.7	1/2	3/4x16	55	29	28	22 mm	1.6
33982-10-10	16	-10	15.9	5/8	7/8x14	74	37	31	1	1.6
33982-12-12	20	-12	19.1	3/4	1-1/16x12	84	46	46	1-1/4	1.6
33982-12-12-SM	20	-12	19.1	3/4	1-1/16x12	83	46	48	32 mm	1.6

30882 – SAE (JIC) 45° female swivel

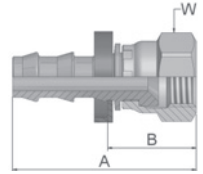

MATERIAL Galvanised steel with transparent Cr(IV)-free plating.
B: Brass

Part No. #	DN	size	mm	inch	Thread size UNF	A mm	B mm	W inch	Max. WP MPa
30882-4-4	6	-4	6.3	1/4	7/16x20	39	19	9/16	1.6
30882-4-4B	6	-4	6.3	1/4	7/16x20	39	19	9/16	1.6
30882-5-4B	6	-4	6.3	1/4	1/2x20	40	21	5/8	1.6
30882-6-6	10	-6	9.5	3/8	5/8x18	46	23	3/4	1.6
30882-6-6B	10	-6	9.5	3/8	5/8x18	46	23	3/4	1.6
30882-8-8	12	-8	12.7	1/2	3/4x16	51	25	7/8	1.6
30882-8-8B	12	-8	12.7	1/2	3/4x16	51	25	7/8	1.6
30882-10-10	16	-10	15.9	5/8	7/8x14	65	28	1	1.6
30882-10-10B	16	-10	15.9	5/8	7/8x14	65	28	1	1.6
30882-12-12	20	-12	19.1	3/4	1-1/16x14	67	30	1-1/4	1.6
30882-12-12B	20	-12	19.1	3/4	1-1/16x14	67	30	1-1/4	1.6

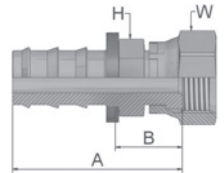
3JC82 – O-Lok® ORFS swivel nut
ISO 12151-1-SWSA – SAE J516 – ORFS

MATERIAL Galvanised steel with transparent Cr(IV)-free plating.
SM: Metric wrench size

Part No. #	DN	size	mm	inch	Thread size UNF	A mm	B mm	H mm	W inch	Max. WP MPa
3JC82-4-4	6	-4	6.3	1/4	9/16x18	36	17	9/16	11/16	1.6
3JC82-6-6	10	-6	9.5	3/8	11/16x16	40	18	11/16	13/16	1.6
3JC82-6-6-SM	10	-6	9.5	3/8	11/16x16	41	18	19	22 mm	1.6
3JC82-8-6-SM	10	-6	9.5	3/8	13/16x16	43	20	22	24 mm	1.6
3JC82-8-8	12	-8	12.7	1/2	13/16x16	47	20	22	15/16	1.6
3JC82-8-8-SM	12	-8	12.7	1/2	13/16x16	47	20	22	24 mm	1.6
3JC82-8-10	16	-10	15.9	5/8	13/16x16	57	21	3/4	15/16	1.6
3JC82-8-10-SM	16	-10	15.9	5/8	13/16x16	57	21	22	24 mm	1.6
3JC82-10-10	16	-10	15.9	5/8	1x14	61	24	15/16	1-1/8	1.6
3JC82-10-12	20	-12	19.1	3/4	1x14	61	24	1	1-1/8	1.6
3JC82-12-12	20	-12	19.1	3/4	1-3/16x12	67	30	1-1/8	1-3/8	1.6

3FF82 – Metru-Lok female swivel

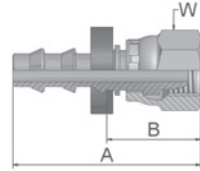

MATERIAL B: Brass

Part No. #	DN size				Connection type		A mm	B mm	W mm	Max. WP MPa
	mm	inch	Thread size metric	Tube OD mm						
3FF82-6-4B	6	-4	6.3	1/4	M10x1	6	36	16	14	1.6
3FF82-8-4B	6	-4	6.3	1/4	M12x1	8	31	12	14	1.6
3FF82-10-6B	10	-6	9.5	3/8	M14x1	10	35	12	17	1.6
3FF82-12-6B	10	-6	9.5	3/8	M16x1	12	35	12	19	1.6
3FF82-14-8B	12	-8	12.7	1/2	M18x1	14	38	12	22	1.6
3FF82-16-8B	12	-8	12.7	1/2	M22x1.5	16	38	12	24	1.6
3FF82-18-10B	16	-10	15.9	5/8	M24x1.5	18	51	15	27	1.6
3FF82-22-12B	20	-12	19.1	3/4	M28x1.5	22	51	15	32	1.6

3AF82 – BSP male with O-ring sealing

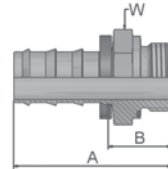

MATERIAL B: Brass; C: Stainless steel

Part No. #	DN size				Thread size BSP	A mm	B mm	W mm	Max. WP MPa
	mm	inch	Thread size BSP						
3AF82-2-4B	6	-4	6.3	1/4	1/8x28	34	15	17	1.6
3AF82-4-4B	6	-4	6.3	1/4	1/4x19	39	20	19	1.6
3AF82-4-4C	6	-4	6.3	1/4	1/4x19	39	20	19	1.6
3AF82-4-6B	10	-6	9.5	3/8	1/4x19	43	20	19	1.6
3AF82-6-6B	10	-6	9.5	3/8	3/8x19	46	23	22	1.6
3AF82-6-8B	12	-8	12.7	1/2	3/8x19	49	22	22	1.6
3AF82-8-8B	12	-8	12.7	1/2	1/2x14	53	26	27	1.6
3AF82-8-10B	16	-10	15.9	5/8	1/2x14	63	26	27	1.6

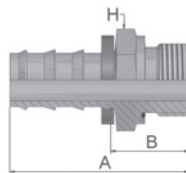
3NM82 – BSP male with ED sealing
ISO 1179**MATERIAL** B: Brass

Part No. #	DN size				Thread size BSP	A mm	B mm	H mm	Max. WP MPa
	mm	inch	mm	inch					
3NM82-6-8B	12	-8	12.7	1/2	3/8x19	52	26	22	1.6
3NM82-8-8B	12	-8	12.7	1/2	1/2x14	55	28	27	1.6
3NM82-12-12B	20	-12	19.1	3/4	3/4x14	65	28	32	1.6

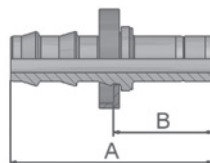

NOTE Fittings are delivered with ED-Seal.
Working temperature from -30 °C up to +105 °C.**3YW82 – A-Lok® metric standpipe****MATERIAL** C: Stainless steel

Part No. #	DN size				A mm	B mm	Max. WP MPa
	mm	inch	mm	inch			
3YW82-6-4C-ROUND	6	-4	6.3	1/4	39	20	1.6
3YW82-8-4C-ROUND	6	-4	6.3	1/4	40	21	1.6
3YW82-10-6C-ROUND	10	-6	9.5	3/8	44	22	1.6
3YW82-12-8C-ROUND	12	-8	12.7	1/2	54	27	1.6
3YW82-18-10C-ROUND	16	-10	15.9	5/8	65	29	1.6

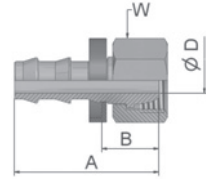
VW121 – BSP female swivel
 acc. VW standard 39-V-16 631



MATERIAL Brass
 *: Stainless steel nipple, stainless steel swivel nut
 **: Brass nipple, stainless steel swivel nut

Part No. #	DN	size	mm	inch	Thread size BSP 	A mm	B mm	D mm	W mm 	Max. WP MPa 
VW121-8937*	6	-4	6.3	1/4	1/4x19	32	13	5.0	17	1.6
VW121-8938	10	-6	9.5	3/8	3/8x19	38	15	7.5	19	1.6
VW121-8939	12	-8	12.7	1/2	1/2x14	46	19	11.0	27	1.6
VW121-8940	16	-10	15.9	5/8	3/4x14	58	21	14.0	32	1.6
VW121-8941**	20	-12	19.0	3/4	1x11	53	16	17.0	41	1.6

34982 – Banjo union

DIN 7642

MATERIAL Galvanised steel with transparent Cr(IV)-free plating.
C: Stainless steel

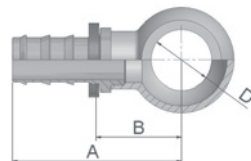

Part No. #	DN	size	mm	inch	D mm	A mm	B mm	Max. WP MPa
34982-8-4	6	-4	6.3	1/4	8	36	17	1.6
34982-10-4	6	-4	6.3	1/4	10	38	19	1.6
34982-12-4	6	-4	6.3	1/4	12	40	21	1.6
34982-14-4	6	-4	6.3	1/4	14	42	23	1.6
34982-14-4C	6	-4	6.3	1/4	14	42	23	1.6
34982-10-6	10	-6	9.5	3/8	10	42	19	1.6
34982-12-6	10	-6	9.5	3/8	12	44	21	1.6
34982-14-6	10	-6	9.5	3/8	14	47	24	1.6
34982-14-6C	10	-6	9.5	3/8	14	47	24	1.6
34982-16-6	10	-6	9.5	3/8	16	49	26	1.6
34982-17-6	10	-6	9.5	3/8	17	49	26	1.6
34982-17-6C	10	-6	9.5	3/8	17	49	26	1.6
34982-14-8	12	-8	12.7	1/2	14	51	25	1.6
34982-18-8	12	-8	12.7	1/2	18	55	28	1.6
34982-22-8	12	-8	12.7	1/2	22	58	31	1.6
34982-22-10	16	-10	15.9	5/8	22	68	32	1.6
34982-26-12	20	-12	19.1	3/4	26	73	37	1.6

38282 – Push-Lok® connector

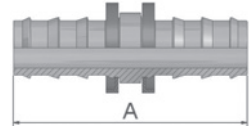

MATERIAL Galvanised steel with transparent Cr(IV)-free plating.
B: Brass

Part No. #	DN	size	mm	inch	A mm	Max. WP MPa
38282-4-4	6	-4	6.3	1/4	45	1.6
38282-4-4B	6	-4	6.3	1/4	45	1.6
38282-6-6	10	-6	9.5	3/8	54	1.6
38282-6-6B	10	-6	9.5	3/8	54	1.6
38282-8-8	12	-8	12.7	1/2	64	1.6
38282-8-8B	12	-8	12.7	1/2	64	1.6
38282-10-10	16	-10	15.9	5/8	84	1.6
38282-10-10B	16	-10	15.9	5/8	84	1.6
38282-12-12	20	-12	19.0	3/4	84	1.6
38282-12-12B	20	-12	19.1	3/4	84	1.6

DP – Metric female swivel Tee / male stud

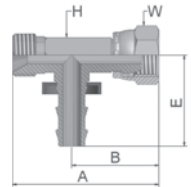



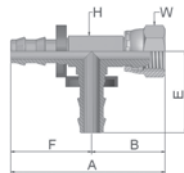

MATERIAL Brass nipple, galvanised steel swivel nut.
Standard version without plastic ring.
When ordering with plastic ring: use Part No. without “K”.

Part No. #	DN	size	mm	inch	Thread size metric	A mm	B mm	E mm	H mm	W mm	Max. WP MPa
DP-6-6-4BK	6	-4	6.3	1/4	M12x1	43	24	30	11	14	1.6
DP-8-8-4BK	6	-4	6.3	1/4	M14x1.5	43	24	30	11	14	1.6
DP-10-10-6BK	10	-6	9.5	3/8	M16x1.5	48	26	34	13	19	1.6
DP-15-15-8BK	12	-8	12.7	1/2	M22x1.5	58	32	42	17	27	1.6

DR – Metric female swivel Tee / male stud

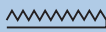

MATERIAL Galvanised steel with transparent Cr(IV)-free plating.
B: Brass; C: Stainless steel; K: without plastic ring

Part No. #	DN	size	mm	inch	Thread size metric	A mm	B mm	E mm	F mm	H mm	W mm	Max. WP MPa
												
DR-6-4-4BK	6	-4	6.3	1/4	M12x1	54	24	30	30	11	14	1.6
DR-10-6-6BK	10	-6	9.5	3/8	M16x1.5	59	25	34	34	13	19	1.6
DR-15-8-8BK	12	-8	12.7	1/2	M22x1.5	74	32	42	42	17	27	1.6

Chapter C**PTFE/Fluoropolymer hose and fittings****PTFE hose**

General statements	C-2
2030T – PTFE hose.....	C-3
2030T-##R14 – PTFE hose acc. to SAE 100 R14	C-4
2030T-##CON – PTFE hose – convoluted	C-5
2030TB-##CON – PTFE hose – convoluted, conductive	C-6
2033T – PTFE hose.....	C-7
919U – PTFE hose with PU cover	C-8
929/929B – Heavy-wall PTFE hose.....	C-9
939/939B – PTFE hose – convoluted	C-10
2380F – FEP high pressure hose	C-11
2246F – FEP high pressure hose	C-12

Fittings for PTFE hose

91N series	C-13
93N series	C-30
PC series	C-33
YX series	C-45

PTFE hose

PTFE/Fluoropolymer hose – General statements

Why is PTFE a superior hose core material?

PTFE (polytetrafluoroethylene) is a high performance fluoroplastic with high crystallinity and high molecular weight, discovered in 1938 by DuPont chemist, Dr. Roy J. Plunkett. PTFE is more commonly known as Teflon®, the DuPont trade name for PTFE.

Parker PTFE hose provides full conveyance solutions for a wide array of markets and applications because of the unique properties of PTFE.

Unique properties of PTFE

- Chemical resistance:** inert to virtually all chemicals
- Extreme temperature ranges:** applicable from -70 °C up to +230 °C (depending on hose type)
- Smooth surface:** minimizes pressure drop and deposits on hose inner surface, easy to clean
- Extremely flexibel:** convoluted designs have excellent bend radius properties
- Resists moisture:** low tendency to hydrolysis
- Unlimited shelf life of bulk hose**

Static dissipation and PTFE hoses

In the case of a PTFE hose, static electricity is caused when a non-conducting fluid flows at a high velocity through the PTFE natural core tube. When a static charge builds up in the tube of a PTFE hose, it will look for the path of least resistance to ground. If the tube is non-conductive, then the path of least resistance may be to pierce through the wall of the PTFE tube to the conductive stainless steel braid and eventually to the metal fittings and back to ground through the equipment to which the hose assembly is connected.

The purpose of a static dissipating tube on the inside of the hose is to provide an acceptable path of less resistance and allow the static buildup to dissipate through the core tube to the metal fittings and eventually to ground. Parker static-dissipating hose is designated with a B after the product number. Example: Hose type 919B-6 is the static-dissipative version of hose type 919-6.

2030T – PTFE hose



MAIN FEATURES

- Suitable for high temperatures
- Inert to virtually all hydraulic and chemical fluids

APPLICATIONS

Medium pressure service for use with hydraulic fluids at high temperatures and aggressive chemicals in the chemical industry, surface engineering, 2-component systems.

The core tube material conforms to FDA 21 CFR177.1550.

CONSTRUCTION

Core tube : Polytetrafluoroethylene (Teflon® T62)
Pressure reinforcement : One braided layer of stainless steel wire

Cover : –

Colour : –

TEMPERATURE RANGE

-50°C up to +150°C permanent temperature
 +230°C at working pressures up to 2 MPa

Part No. #	DN	size		mm	mm	Max. working pressure		Min. burst pressure		Min. bend radius	Weight	Fittings
		mm	inch			MPa	psi	MPa	psi			
2030T-03V70	5	-03	4.7	3/16	7.8	27.5	3,985	110.0	15,950	50	0.09	YX
2030T-04V70	6	-04	6.3	1/4	9.5	24.0	3,480	96.0	13,920	75	0.13	YX
2030T-05V70	8	-05	8.2	5/16	11.5	20.0	2,900	80.0	11,600	100	0.17	YX
2030T-06V70	10	-06	9.7	3/8	13.0	17.5	2,535	70.0	10,150	120	0.19	YX
2030T-08V70	12	-08	12.8	1/2	16.7	15.0	2,175	60.0	8,700	135	0.29	YX
2030T-10V70	16	-10	16.0	5/8	20.0	12.5	1,810	50.0	7,250	160	0.34	YX
2030T-12V70	20	-12	19.4	3/4	23.5	10.0	1,450	40.0	5,800	200	0.41	YX
2030T-16V70	25	-16	25.0	1	29.0	8.0	1,160	32.0	4,640	250	0.51	YX

NOTES

- Not recommended for dynamic applications.
- Teflon® is a registered trademark of the DuPont company.

2030T-##R14 – PTFE hose

Performance acc. to SAE 100 R14



MAIN FEATURES

- **Conforms to requirements of SAE 100R14**
- 100% working pressure at continuous temperatures of 204 °C max.
- Inert to virtually all hydraulic and chemical fluids
- One-piece fittings suitable for the Parker assembly system

APPLICATIONS

Medium pressure service for use with hydraulic fluids at high temperatures, steam and aggressive chemicals in the chemical industry. Especially suitable for the food industry.
The core tube material conforms to FDA 21 CFR177.1550.

CONSTRUCTION

Core tube : Polytetrafluoroethylene (Teflon® T62)
Pressure reinforcement : One braided layer of stainless steel wire

Cover : -

Colour : -

TEMPERATURE RANGE

-54°C up to +232°C (100% working pressure at 204°C)

Part No. #	ID		AD		Wall thickness mm	Max. working pressure MPa / psi		Min. burst pressure MPa / psi		Min. bend radius mm	Weight kg/m	Fittings
	mm	inch	mm	inch								
2030T-04R14	4.8	3/16	7.9	5/16	0.76	21.0	3,000	83.0	12,000	51	0.09	91N
2030T-05R14	6.4	1/4	9.5	3/8	0.76	21.0	3,000	83.0	12,000	76	0.13	91N
2030T-06R14	7.9	5/16	11.1	7/16	0.76	17.5	2,500	69.0	10,000	101	0.15	91N
2030T-08R14	10.3	13/32	13.5	17/32	0.76	14.0	2,000	56.0	8,000	127	0.19	91N
2030T-10R14	12.7	1/2	15.9	5/8	0.76	10.3	1,500	41.5	6,000	165	0.22	91N
2030T-12R14	15.9	5/8	19.1	3/4	0.76	8.3	1,200	34.5	5,000	191	0.28	91N
2030T-16R14	22.2	7/8	26.2	1 1/32	0.89	6.9	1,000	27.5	4,000	229	0.40	91N

NOTES

Teflon® is a registered trademark of the DuPont company.

2030T-##CON – PTFE hose – convoluted



MAIN FEATURES

- Suitable for high temperatures
- Inert to virtually all hydraulic and chemical fluids
- **Extremely flexible and small bend radius**

APPLICATIONS

Medium pressure service for use with hydraulic fluids at **high temperatures** and **aggressive fluids** in the chemical and other industries, when **small bend radii and high flexibility** are required.

The core tube material conforms to FDA 21 CFR177.1550. Due to its high purity the hose can also be used in the food industry.

CONSTRUCTION

Core tube : Polytetrafluoroethylene (Teflon® T62)
Pressure reinforcement : One braided layer of stainless steel wire (AISI 304)

Cover : -

Colour : -

TEMPERATURE RANGE

-70°C up to +230°C

Part No. #	DN size				min. mm		max. mm		Max. working pressure		Min. burst pressure		Min. bend radius	Weight	Fittings
	mm	inch	mm	inch	mm	mm	MPa	psi	MPa	psi	mm	kg/m			
2030T-04CON	6	-04	6.4	1/4	9.3	9.9	17.2	2,500	68.8	10,000	18	0.11	PC		
2030T-05CON	8	-05	8.2	5/16	12.3	12.9	15.5	2,250	62.0	9,000	25	0.16	PC		
2030T-06CON	10	-06	9.9	3/8	13.8	14.5	13.8	2,000	55.2	8,000	30	0.21	PC		
2030T-08CON	12	-08	12.8	1/2	17.8	18.5	10.3	1,500	41.2	6,000	40	0.25	PC		
2030T-10CON	16	-10	16.0	5/8	22.2	23.1	8.3	1,200	33.2	4,800	51	0.30	PC		
2030T-12CON	20	-12	19.3	3/4	24.0	25.2	6.9	1,000	27.6	4,000	64	0.37	PC		
2030T-16CON	25	-16	25.5	1	32.2	33.3	4.6	670	18.4	2,680	89	0.54	PC		
2030T-20CON	32	-20	32.2	1 1/4	40.2	41.5	3.4	490	13.6	1,960	125	0.69	1)		

NOTES

- 1) Factory made assemblies only for size -20.
- For temperatures above 120 °C working pressure is to be adjusted by 1% for each temperature increase of 1 °C (Example: for 170 °C the max. WP is 50% of the value indicated in the table).
 - Bigger sizes available on request.
 - Teflon® is a registered trademark of the DuPont company.

2030TB-##CON – PTFE hose – convoluted, conductive



MAIN FEATURES

- Suitable for high temperatures
- Inert to virtually all hydraulic and chemical fluids
- **Extremely flexible and small bend radius**
- **For use in explosion protected areas with black, conductive core tube**

APPLICATIONS

Medium pressure service for use with hydraulic fluids at **high temperatures** and **aggressive fluids** in the chemical and other industries, when **small bend radii and high flexibility** are required.

CONSTRUCTION

Core tube : Polytetrafluoroethylene (Teflon® T62), conductive
Pressure reinforcement : One braided layer of stainless steel wire (AISI 304)

Cover : -

Colour : -

TEMPERATURE RANGE

-70°C up to +230°C

Part No. #	DN size				min. max.		Max. working pressure		Min. burst pressure		Min. bend	Weight	Fittings
	mm	inch	mm	mm	MPa / psi	MPa / psi	radius	kg/m					
2030TB-04CON	6	-04	6.4	1/4	9.1	9.7	17.2	2,500	68.8	10,000	18	0.18	PC
2030TB-05CON	8	-05	7.9	5/16	12.2	12.7	15.5	2,250	62.0	9,000	25	0.20	PC
2030TB-06CON	10	-06	9.5	3/8	12.9	14.0	13.8	2,000	55.2	8,000	30	0.21	PC
2030TB-08CON	12	-08	12.7	1/2	18.2	19.2	10.3	1,500	41.2	6,000	40	0.30	PC
2030TB-10CON	16	-10	15.9	5/8	21.6	22.6	8.3	1,200	33.2	4,800	51	0.36	PC
2030TB-12CON	20	-12	19.1	3/4	24.0	25.3	6.9	1,000	27.6	4,000	80	0.43	PC
2030TB-16CON	25	-16	25.4	1	32.1	33.7	4.6	670	18.4	2,680	89	0.65	PC
2030TB-20CON	32	-20	32.2	1 1/4	40.2	41.2	3.4	490	13.6	1,960	125	0.75	1)

NOTES

- 1) Factory made assemblies only for size -20.
- For temperatures above 120 °C working pressure is to be adjusted by 1% for each temperature increase of 1 °C (Example: for 170 °C the max. WP is 50% of the value indicated in the table).
 - Bigger sizes available on request.
 - Teflon® is a registered trademark of the DuPont company.

2033T – PTFE hose



MAIN FEATURES

- Increased working pressure due to two braided layers of stainless steel wire
- Suitable for high temperatures
- Inert to virtually all hydraulic and chemical fluids

APPLICATIONS

Medium pressure service for use with hydraulic fluids at high temperatures and aggressive chemicals in the chemical industry, surface engineering, 2-component systems.

The core tube material conforms to FDA 21 CFR177.1550.

CONSTRUCTION

Core tube : Polytetrafluoroethylene (Teflon® T62)
Pressure reinforcement : Two braided layers of stainless steel wire

Cover : –

Colour : –

TEMPERATURE RANGE

-50°C up to +150°C permanent temperature
 +230°C at working pressures up to 2 MPa

Part No. #	DN size				mm	Max. working pressure		Min. burst pressure		Min. bend radius	Weight	Fittings
	mm	inch	mm	mm		MPa / psi	MPa / psi	mm	kg/m			
2033T-04V70	6	-04	6.3	1/4	11.0	27.5	3,985	110.0	15,950	75	0.23	PX 1)
2033T-05V70	8	-05	8.2	5/16	13.2	25.0	3,625	100.0	14,500	100	0.26	PX 1)
2033T-06V70	10	-06	9.7	3/8	15.0	22.5	3,260	90.0	13,050	120	0.34	PX 1)
2033T-08V70	12	-08	12.8	1/2	18.6	20.0	2,900	80.0	11,600	135	0.47	PX 1)
2033T-10V70	16	-10	16.0	5/8	21.5	17.5	2,535	70.0	10,150	160	0.53	YX
2033T-12V70	20	-12	19.4	3/4	25.5	15.0	2,175	60.0	8,700	200	0.69	YX
2033T-16V70	25	-16	25.0	1	31.0	11.0	1,595	44.0	6,380	250	0.81	YX

NOTES

- 1) Please refer to chapter E for the PX series fittings (page E-115 ff.).
- Not recommended for dynamic applications.
 - Teflon® is a registered trademark of the DuPont company.

919U – PTFE hose with PU cover

Performance exceeds SAE 100 R14A



MAIN FEATURES

- With polyurethane cover
- Inert to virtually all hydraulic and chemical fluids
- One-piece fittings suitable for the Parker assembly system

APPLICATIONS

Medium pressure service for use with hydraulic fluids at high temperatures and aggressive chemicals in the chemical industry, when **high abrasion resistance** is required. Suitable for the food industry. The core tube material conforms to FDA 21 CFR177.1550.

CONSTRUCTION

Core tube : Polytetrafluoroethylene
Pressure reinforcement : One braided layer of stainless steel wire

Cover : Polyurethane
Colour : black

TEMPERATURE RANGE

-40°C up to +135°C

Part No. #	ID		AD		Wall thickness mm	Max. working pressure MPa / psi		Min. burst pressure MPa / psi		Min. bend radius mm	Weight kg/m	Fittings
	mm	inch	mm	inch								
919U-4	4.8	3/16	9.5	3/8	0.76	21.0	3,000	83.0	12,000	51	0.12	91N
919U-6	7.9	5/16	12.7	1/2	0.76	17.5	2,500	69.0	10,000	101	0.20	91N
919U-8	10.3	13/32	15.9	5/8	0.76	14.0	2,000	56.0	8,000	127	0.22	91N
919U-12	15.9	5/8	21.4	27/32	0.76	8.3	1,200	34.5	5,000	191	0.33	91N
919U-16	22.2	7/8	27.0	1 1/16	0.89	6.9	1,000	27.5	4,000	229	0.47	91N

NOTES

- Vacuum rating: 95 kPa (13,8 psi) size -4 up to -8
40 kPa (5,8 psi) size -12
47 kPa (6,8 psi) size -16.
- Cover must be skived prior to fitting attachment.

929/929B – Heavy-wall PTFE hose

929: Performance acc./exceeds SAE 100 R14A

929B: Performance exceeds SAE 100 R14B

**MAIN FEATURES**

- **Heavy-wall core tube**
- Suitable for high temperatures
- Inert to virtually all hydraulic and chemical fluids
- One-piece fittings suitable for the Parker assembly system

APPLICATIONS

Medium pressure service for use with hydraulic fluids at high temperatures, steam and aggressive chemicals in the chemical industry, when **low permeation is essential**.

Suitable for the food industry. The core tube material conforms to FDA 21 CFR177.1550 (except 929B).

CONSTRUCTION

Core tube : Heavy-wall polytetrafluoroethylene; 929B: conductive
Pressure reinforcement : One braided layer of stainless steel wire

Cover : –

Colour : –

TEMPERATURE RANGE

-73°C up to +232°C

Part No. #	ID		AD		Wall thickness mm	Max. working pressure MPa / psi		Min. burst pressure MPa / psi		Min. bend radius mm	Weight kg/m	Fittings
	mm	inch	mm	inch								
929/929B-4	4.8	3/16	7.9	5/16	1.02	21.0	3,000	83.0	12,000	38	0.12	91N
929/929B-6	7.9	5/16	11.1	7/16	1.02	17.5	2,500	69.0	10,000	89	0.18	91N
929/929B-8	10.3	13/32	14.3	9/16	1.07	14.0	2,000	56.0	8,000	114	0.23	91N
929/929B-12	15.9	5/8	19.1	3/4	1.22	8.4	1,200	33.6	4,800	165	0.28	91N
929/929B-16	22.2	7/8	28.6	1 1/8	1.22	8.8	1,250	35.0	5,000	188	0.73	91N

NOTES

- Vacuum rating: 95 kPa (13,8 psi) size -4 up to -8
40 kPa (5,8 psi) size -12
47 kPa (6,8 psi) size -16.
- 929B for use in explosion protected areas with black, static dissipative core tube.

939/939B – PTFE hose – convoluted



MAIN FEATURES

- Suitable for high temperatures
- Inert to virtually all hydraulic and chemical fluids
- **Extremely flexible and small bend radius**

APPLICATIONS

Medium pressure service for use with hydraulic fluids at **high temperatures** and **aggressive fluids** in the chemical and other industries, when **small bend radii and high flexibility** are required.
The core tube material conforms to FDA 21 CFR177.1550 (except 939B).

CONSTRUCTION

Core tube : Polytetrafluoroethylene, 939B: conductive
Pressure reinforcement : One braided layer of stainless steel wire

Cover : –

Colour : –

TEMPERATURE RANGE

-73°C up to +232°C

Part No. #	DN size				mm	Max. working pressure		Min. burst pressure		Min. bend radius	Weight	Fittings
	mm	inch	mm	inch		MPa	psi	MPa	psi			
939/939B-6	10	-06	9.5	3/8	15.0	10.3	1,500	41.5	6,000	57	0.18	93N
939/939B-8	12	-08	12.7	1/2	20.1	9.5	1,350	37.5	5,400	73	0.31	93N
939/939B-10	16	-10	15.9	5/8	22.4	6.9	1,000	27.5	4,000	76	0.36	93N
939/939B-12	20	-12	19.1	3/4	27.7	7.5	1,100	30.5	4,400	95	0.47	93N
939/939B-16	25	-16	25.4	1	33.8	6.9	1,000	27.5	4,000	127	0.67	93N
939/939B-20	32	-20	31.8	1 1/4	44.5	6.9	1,000	27.5	4,000	159	1.04	93N
939/939B-24	40	-24	38.1	1 1/2	52.1	5.0	750	21.0	3,000	191	1.18	93N
939/939B-32	50	-32	50.8	2	65.0	1.7	250	6.9	1,000	254	1.50	93N

NOTES

- Vacuum rating: 95 kPa (13,8 psi) size -6 up to -16
67 kPa (9,8 psi) size -20
40 kPa (5,8 psi) size -24
17 kPa (6,8 psi) size -32.
- Not recommended for water/steam circuits.

2380F – FEP high pressure hose



MAIN FEATURES

- Working pressures up to 42 MPa
- With polyurethane cover
- Inert to virtually all hydraulic and chemical fluids

APPLICATIONS

Glue applications in the automotive industry and material lines for temperatures below +80°C.

CONSTRUCTION

Core tube : Fluoroethylenepropylene
Pressure reinforcement : Two spiral layers and two open spiral layers of high tensile steel wire
Cover : Polyurethane
Colour : grey

TEMPERATURE RANGE

-40°C up to +80°C

Part No. #	DN size			mm	Max. working pressure		Min. burst pressure		Min. bend radius	Weight	Fittings	
	mm	inch	mm		MPa / psi	MPa / psi	mm	kg/m				
2380F-04V07	6	-04	6.3	1/4	12.5	42.5	6,160	170.0	24,650	60	0.26	NX ¹⁾
2380F-05V07	8	-05	8.0	5/16	14.3	37.5	5,435	150.0	21,750	85	0.35	NX ¹⁾
2380F-06V07	10	-06	9.7	3/8	17.0	35.0	5,075	140.0	20,300	110	0.41	NX ¹⁾
2380F-08V07	12	-08	12.8	1/2	20.5	32.5	4,710	130.0	18,850	140	0.58	NX ¹⁾
2380F-10V07	16	-10	16.0	5/8	24.5	30.0	4,350	120.0	17,400	175	0.75	NX ¹⁾
2380F-12V07	20	-12	19.4	3/4	28.5	27.5	3,985	110.0	15,950	205	0.96	NX ¹⁾
2380F-16V07	25	-16	25.0	1	34.0	22.5	3,260	90.0	13,050	240	1.28	NX ¹⁾

NOTES

- 1) Please refer to chapter E for the NX series fittings (page E-105 ff.).
- For pinpricked hose please add "-P", e.g. **2380F-04V07-P**.
 - Not recommended for applications where extreme pulsations are encountered.

2246F – FEP high pressure hose



MAIN FEATURES

- Working pressures up to 41.5 MPa
- Without hose cover
- Suitable for temperatures up to 150 °C
- Inert to virtually all hydraulic and chemical fluids

APPLICATIONS

- Suitable for applications with additional heating elements
- Hotmelt applications in the automotive industry

CONSTRUCTION

- Core tube** : Fluoroethylenpropylene
- Pressure reinforcement** : Two spiral layers and one braided layer of high tensile steel wire
- Cover** : –
- Colour** : –

TEMPERATURE RANGE

-50°C up to +150°C

Part No. #	DN size				mm	Max. working pressure		Min. burst pressure		Min. bend radius	Weight	Fittings
	mm	inch	MPa	psi		MPa	psi	kg/m				
2246F-04V70	6	-04	6.3	1/4	11.4	41.5	6,015	165.0	23,925	60	0.26	NX ¹⁾
2246F-05V70	8	-05	8.2	5/16	13.5	37.5	5,435	150.0	21,750	85	0.33	NX ¹⁾
2246F-06V70	10	-06	9.7	3/8	16.0	34.0	4,930	136.0	19,720	110	0.35	NX ¹⁾
2246F-08V70	12	-08	12.8	1/2	18.5	32.5	4,710	130.0	18,850	140	0.53	NX ¹⁾
2246F-10V70	16	-10	16.0	5/8	23.4	30.0	4,350	120.0	17,400	175	0.70	NX ¹⁾
2246F-12V70	20	-12	19.4	3/4	27.0	26.5	3,840	106.0	15,370	205	0.92	NX ¹⁾
2246F-16V70	25	-16	25.0	1	32.5	21.0	3,045	84.0	12,180	240	1.18	NX ¹⁾

NOTES

- 1) Please refer to chapter E for the NX series fittings (page E-105 ff.).
- Not recommended for applications where extreme pulsations are encountered.

1C391N – Metric female swivel 24°/60°

Light series – Metric swivel nut

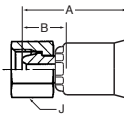

MATERIAL Galvanised steel with transparent Cr(IV)-free plating.
For stainless steel (AISI 316) please add **C** to the Part No. Example: 1C391N-6-4**C**.
Other materials available on request.

Part No. #	DN size			mm		inch		Connection type		A mm	B mm	J mm	Max. WP MPa
	Thread size	Tube OD mm	Thread size	Tube OD mm	Thread size	Tube OD mm							
1C391N-6-4-RD	5	-04	4.8	3/16	M12x1.5	6	29	14	14	25.0			
1C391N-6-5-RD	6	-05	6.4	1/4	M12x1.5	6	30	14	14	25.0			
1C391N-8-5-RD	6	-05	6.4	1/4	M14x1.5	8	31	14	17	25.0			
1C391N-8-6-RD	8	-06	7.9	5/16	M14x1.5	8	32	14	17	25.0			
1C391N-10-6-RD	8	-06	7.9	5/16	M16x1.5	10	34	16	19	25.0			
1C391N-10-8-RD	10	-08	10.3	13/32	M16x1.5	10	36	17	19	25.0			
1C391N-12-8-RD	10	-08	10.3	13/32	M18x1.5	12	35	15	22	25.0			
1C391N-12-10-RD	12	-10	12.7	1/2	M18x1.5	12	38	18	22	25.0			
1C391N-15-10-RD	12	-10	12.7	1/2	M22x1.5	15	37	17	27	25.0			
1C391N-18-10-RD	12	-10	12.7	1/2	M26x1.5	18	37	17	32	16.0			
1C391N-18-12-RD	16	-12	15.9	5/8	M26x1.5	18	40	17	32	16.0			
1C391N-22-16-RD	22	-16	22.2	7/8	M30x2	22	49	22	36	16.0			
1C391N-28-20-RD	28	-20	28.6	1 1/8	M36x2	28	54	29	41	10.0			



1D091N – Metric male 24°

Light series – Metric swivel nut

ISO 12151-2

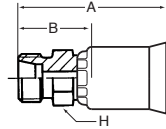

MATERIAL Galvanised steel with transparent Cr(IV)-free plating.
For stainless steel (AISI 316) please add **C** to the Part No. Example: 1D091N-8-6**C**.
Other materials available on request.

Part No. #	DN size mm inch				Connection type		A mm	B mm	H mm	Max. WP MPa
	Thread size	Tube OD mm								
1D091N-6-4	5	-04	4.8	3/16	M12x1.5	6	31	16	12	25.0
1D091N-8-5	6	-05	6.4	1/4	M14x1.5	8	33	16	14	42.5
1D091N-8-6	8	-06	7.9	5/16	M14x1.5	8	34	16	14	42.5
1D091N-10-6	8	-06	7.9	5/16	M16x1.5	10	35	17	17	40.0
1D091N-10-8	10	-08	10.3	13/32	M16x1.5	10	39	19	17	40.0
1D091N-12-8	10	-08	10.3	13/32	M18x1.5	12	39	19	19	35.0
1D091N-12-10	12	-10	12.7	1/2	M18x1.5	12	41	20	19	35.0
1D091N-15-10	12	-10	12.7	1/2	M22x1.5	15	42	21	22	31.0
1D091N-18-12	16	-12	15.9	5/8	M26x1.5	18	46	23	27	28.0
1D091N-22-16	22	-16	22.2	7/8	M30x2	22	54	27	30	28.0
1D091N-28-20	28	-20	28.6	1 1/8	M36x2	28	57	32	36	21.0

91N series

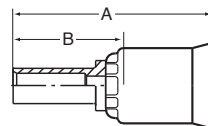
11D91N – Metric standpipe**Light series**

MATERIAL Galvanised steel with transparent Cr(IV)-free plating.
For stainless steel (AISI 316) please add **C** to the Part No. Example: 11D91N-8-6**C**.
Other materials available on request.

Part No. #	DN	size	mm	inch	Tube OD mm	A mm	B mm	Max. WP MPa
11D91N-6-4	5	-04	4.8	3/16	6	44	29	25.0
11D91N-6-5	6	-05	6.4	1/4	6	43	26	25.0
11D91N-8-5	6	-05	6.4	1/4	8	47	30	25.0
11D91N-8-6	8	-06	7.9	5/16	8	46	28	25.0
11D91N-10-6	8	-06	7.9	5/16	10	45	27	25.0
11D91N-10-8	10	-08	10.3	13/32	10	47	27	25.0
11D91N-12-8	10	-08	10.3	13/32	12	53	34	25.0
11D91N-12-10	12	-10	12.7	1/2	12	47	27	25.0
11D91N-15-10	12	-10	12.7	1/2	15	49	29	25.0
11D91N-18-10	12	-10	12.7	1/2	18	50	30	16.0
11D91N-18-12	16	-12	15.9	5/8	18	53	30	16.0
11D91N-22-16	22	-16	22.2	7/8	22	60	33	16.0
11D91N-28-20	28	-20	28.6	1 1/8	28	67	42	10.0



13D91N – Metric standpipe

Heavy series

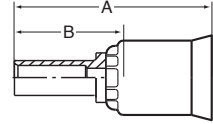

MATERIAL Galvanised steel with transparent Cr(IV)-free plating.
For stainless steel (AISI 316) please add **C** to the Part No. Example: 13D91N-6-3**C**.
Other materials available on request.

Part No. #	DN size		mm		inch		Tube OD	A	B	Max. WP
	mm	inch	mm	inch	mm	mm	mm	mm	MPa	
13D91N-6-3	3	-03	3.2	1/8	6	41	30	63.0		
13D91N-8-4	5	-04	4.8	3/16	8	43	27	63.0		
13D91N-10-5	6	-05	6.4	1/4	10	46	29	63.0		
13D91N-12-6	8	-06	7.9	5/16	12	48	30	63.0		
13D91N-14-8	10	-08	10.3	13/32	14	53	33	63.0		
13D91N-16-10	12	-06	12.7	1/2	16	55	35	40.0		
13D91N-20-12	16	-10	15.9	5/8	20	63	40	40.0		
13D91N-25-16	22	-12	22.2	7/8	25	71	44	40.0		
13D91N-30-16	22	-16	22.2	7/8	30	75	48	25.0		

91N series

19291N – BSP female swivel 60° cone

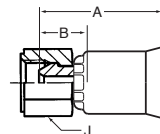

MATERIAL Galvanised steel with transparent Cr(IV)-free plating.
For stainless steel (AISI 316) please add **C** to the
Part No. Example: 19291N-4-4**C**-RD.
Other materials available on request.

Part No. #	DN size mm inch				Connection type		A mm	B mm	J mm	Max. WP MPa
	Thread size	Tube OD inch	Hexagon	Pressure						
19291N-4-4-RD	5	-04	4.8	3/16	G 1/4	1/4	27	11	19	63.0
19291N-4-5-RD	6	-05	6.4	1/4	G 1/4	1/4	28	11	19	63.0
19291N-6-6-RD	8	-06	7.9	5/16	G 3/8	3/8	33	15	22	55.0
19291N-6-8-RD	10	-08	10.3	13/32	G 3/8	3/8	34	15	22	55.0
19291N-8-10-RD	12	-10	12.7	1/2	G 1/2	1/2	37	17	27	43.0
19291N-12-12-RD	16	-12	15.9	5/8	G 3/4	3/4	40	17	32	35.0
19291N-12-16-RD	22	-16	22.2	7/8	G 3/4	3/4	46	19	32	35.0

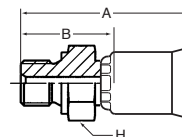
1D991N – BSP male
DIN 3852 Form A

MATERIAL Galvanised steel with transparent Cr(IV)-free plating.
For stainless steel (AISI 316) please add **C** to the
Part No. Example: 1D991N-6-6**C**.
Other materials available on request.



Part No. #	DN size mm inch				Connection type		A mm	B mm	H mm	Max. WP MPa
	Thread size	Tube OD inch	Hexagon	Pressure						
1D991N-4-4	5	-04	4.8	3/16	G 1/4	1/4	38	23	19	63.0
1D991N-4-5	6	-05	6.4	1/4	G 1/4	1/4	38	22	19	63.0
1D991N-6-6	8	-06	7.9	5/16	G 3/8	3/8	40	22	22	55.0
1D991N-6-8	10	-08	10.3	13/32	G 3/8	3/8	41	21	22	55.0
1D991N-8-10	12	-10	12.7	1/2	G 1/2	1/2	47	27	27	43.0
1D991N-12-12	16	-12	15.9	5/8	G 3/4	3/4	51	28	32	35.0
1D991N-12-16	22	-16	22.2	7/8	G 3/4	3/4	57	30	32	35.0

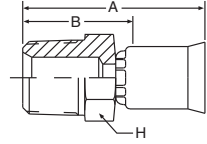

10191N – National Pipe Tapered (NPT) male



MATERIAL Galvanised steel with transparent Cr(IV)-free plating.
For stainless steel (AISI 303) please add **C** to the Part No. Example: 10191N-4-6**C**.
Other materials available on request.

Part No. #	DN size				Connection type Thread size 	A mm	B mm	H inch 	Max. WP MPa 
	mm	inch	mm	inch					
10191N-2-4	5	-04	4.8	3/16	1/8 - 27NPTF	32	19	1/2	34.5
10191N-4-4	5	-04	4.8	3/16	1/4 - 18NPTF	38	24	1/2	34.5
10191N-4-5	6	-05	6.4	1/4	1/4 - 18NPTF	39	25	9/16	34.5
10191N-4-6	8	-06	7.9	5/16	1/4 - 18NPTF	41	24	5/8	34.5
10191N-6-6	8	-06	7.9	5/16	3/8 - 18NPTF	42	25	5/8	27.5
10191N-4-8	10	-08	10.3	13/32	1/4 - 18NPTF	50	30	7/8	34.5
10191N-6-8	10	-08	10.3	13/32	3/8 - 18NPTF	43	25	3/4	27.5
10191N-8-8	10	-08	10.3	13/32	1/2 - 14NPTF	49	32	3/4	24.0
10191N-12-8	10	-08	10.3	13/32	3/4 - 14NPTF	52	35	1	21.0
10191N-8-10	12	-10	12.7	1/2	1/2 - 14NPTF	50	32	7/8	24.0
10191N-8-12	16	-12	15.9	5/8	1/2 - 14NPTF	61	38	1 1/8	24.0
10191N-12-12	16	-12	15.9	5/8	3/4 - 14NPTF	56	35	1	21.0
10191N-16-16	22	-16	22.2	7/8	1 - 11 1/2NPTF	60	38	1 3/8	17.0
10191N-20-20	28	-20	28.6	1 1/8	1 1/4 - 11 1/2NPTF	77	52	1 5/8	15.0

91N series

10691N-RD – SAE (JIC) 37° female swivel UNF swivel nut

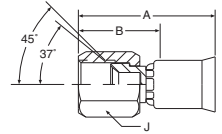

MATERIAL Galvanised steel with transparent Cr(IV)-free plating.
For stainless steel (AISI 316) please add **C** to the
Part No. Example: 10691N-5-5**C**-RD.
Other materials available on request.

Part No. #	DN size				Connection type		A mm	B mm	J inch	Max. WP MPa
	mm	inch	Thread size	Tube OD inch						
10691N-4-4-RD	5	-04	4.8	3/16	7/16 - 20UNF	1/4	34	21	9/16	41.0
10691N-5-5-RD	6	-05	6.4	1/4	1/2 - 20UNF	5/16	38	22	5/8	41.0
10691N-6-6-RD	8	-06	7.9	5/16	9/16 - 18UNF	3/8	41	24	11/16	34.5
10691N-8-8-RD	10	-08	10.3	13/32	3/4 - 16UNF	1/2	45	27	7/8	34.5
10691N-10-10-RD	12	-10	12.7	1/2	7/8 - 14UNF	5/8	49	30	1	34.5
10691N-12-12-RD	16	-12	15.9	5/8	1 1/16 - 12UNF	3/4	53	33	1 1/4	34.5
10691N-16-16-RD	22	-16	22.2	7/8	1 5/16 - 12UNF	1	58	33	1 1/2	27.5

NOTE RD series without hexagonal ferrule.

10691N – SAE (JIC) 37° female swivel UNF swivel nut

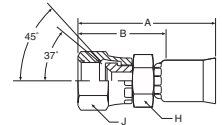

MATERIAL Galvanised steel with transparent Cr(IV)-free plating.
For stainless steel (AISI 316) please add **C** to the
Part No. Example: 10691N-6-6**C**.
Other materials available on request.

Part No. #	DN size				Connection type		A mm	B mm	H inch	J inch	Max. WP MPa
	mm	inch	Thread size	Tube OD inch							
10691N-4-4	5	-04	4.8	3/16	7/16 - 20UNF	1/4	36	22	3/8	9/16	41.0
10691N-5-5	6	-05	6.4	1/4	1/2 - 20UNF	5/16	40	24	7/16	5/8	41.0
10691N-6-6	8	-06	7.9	5/16	9/16 - 18UNF	3/8	41	25	1/2	11/16	34.5
10691N-8-8	10	-08	10.3	13/32	3/4 - 16UNF	1/2	48	30	11/16	7/8	34.5
10691N-10-10	12	-10	12.7	1/2	7/8 - 14UNF	5/8	52	33	13/16	1	34.5
10691N-12-12	16	-12	15.9	5/8	1 1/16 - 12UNF	3/4	54	33	1	1 1/4	34.5
10691N-16-16	22	-16	22.2	7/8	1 5/16 - 12UNF	1	62	40	1 1/4	1 1/2	27.5
10691N-20-20	28	-20	28.6	1 1/8	1 5/8 - 12UNF	1 1/4	76	46	1 5/8	2	20.0



10791N – NPSM female swivel

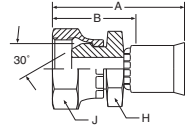

MATERIAL Galvanised steel with transparent Cr(IV)-free plating.
For stainless steel (AISI 303) please add **C** to the Part No. Example: 10791N-4-4**C**.
Other materials available on request.

Part No. #	DN size			mm		inch		Connection type		A mm	B mm	H inch	J inch	Max. WP MPa
	mm	inch	mm	inch	Thread size	Tube OD inch	mm	inch						
10791N-4-4	5	-04	4.8	3/16	1/4 - 18NPSM	1/4	38	24	9/16	3/4	34.5			
10791N-6-6	8	-06	7.9	5/16	3/8 - 18NPSM	3/8	42	25	5/8	7/8	27.5			
10791N-8-8	10	-08	10.3	13/32	1/2 - 14NPSM	1/2	46	29	3/4	1	24.0			
10791N-12-12	16	-12	15.9	5/8	3/4 - 14NPSM	3/4	53	33	1	1 1/4	21.0			
10791N-16-16	22	-16	22.2	7/8	1 - 11 1/2NPSM	1	57	33	1 3/16	1 3/8	17.0			

13791N – SAE (JIC) 37° female swivel 45° elbow – UNF swivel nut

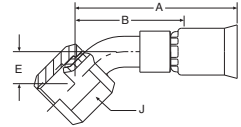

MATERIAL Galvanised steel with transparent Cr(IV)-free plating.
Other materials available on request.

Part No. #	DN size			mm		inch		Connection type		A mm	B mm	E mm	J inch	Max. WP MPa
	mm	inch	mm	inch	Thread size	Tube OD inch	mm	inch						
13791N-4-4	5	-04	4.8	3/16	7/16 - 20UNF	1/4	44	29	8	9/16	41.0			
13791N-5-5	6	-05	6.4	1/4	1/2 - 20UNF	5/16	50	30	9	5/8	41.0			
13791N-6-6	8	-06	7.9	5/16	9/16 - 18UNF	3/8	51	32	14	11/16	34.5			
13791N-8-8	10	-08	10.3	13/32	3/4 - 16UNF	1/2	59	41	14	7/8	34.5			
13791N-10-10	12	-10	12.7	1/2	7/8 - 14UNF	5/8	65	49	16	1	34.5			
13791N-12-12	16	-12	15.9	5/8	1 1/16 - 12UNF	3/4	72	52	20	1 1/4	34.5			
13791N-16-16	22	-16	22.2	7/8	1 5/16 - 12UNF	1	80	57	23	1 1/2	27.5			
13791N-20-20	28	-20	28.6	1 1/8	1 5/8 - 12UNF	1 1/4	87	64	28	2	20.0			

13991N – SAE (JIC) 37° female swivel 90° elbow – UNF swivel nut

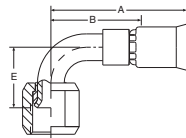

MATERIAL Galvanised steel with transparent Cr(IV)-free plating.
Other materials available on request.

Part No. #	DN size				Connection type		A mm	B mm	E mm	J inch	Max. WP MPa
	mm	inch	Thread size	Tube OD inch							
13991N-4-4	5	-04	4.8	3/16	7/16 - 20UNF	1/4	41	27	24	9/16	41.0
13991N-5-5	6	-05	6.4	1/4	1/2 - 20UNF	5/16	43	29	20	5/8	41.0
13991N-6-6	8	-06	7.9	5/16	9/16 - 18UNF	3/8	49	32	22	11/16	34.5
13991N-8-8	10	-08	10.3	13/32	3/8 - 16UNF	1/2	52	30	28	7/8	34.5
13991N-10-10	12	-10	12.7	1/2	7/8 - 14UNF	5/8	61	43	31	1	34.5
13991N-12-12	16	-12	15.9	5/8	1 1/16 - 12UNF	3/4	76	54	46	1 1/2	34.5
13991N-16-16	22	-16	22.2	7/8	1 5/16 - 12UNF	1	80	56	54	1 1/2	27.5

91N series

14191N – SAE (JIC) 37° female swivel 90° elbow – Long drop length – UNF swivel nut

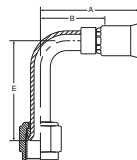

MATERIAL Galvanised steel with transparent Cr(IV)-free plating.
Other materials available on request.

Part No. #	DN size				Connection type		A mm	B mm	E mm	J inch	Max. WP MPa
	mm	inch	Thread size	Tube OD inch							
14191N-4-4	5	-04	4.8	3/16	7/16 - 20UNF	1/4	39	25	46	9/16	41.0
14191N-5-5	6	-05	6.4	1/4	1/2 - 20UNF	5/16	42	25	45	5/8	41.0
14191N-6-6	8	-06	7.9	5/16	9/16 - 18UNF	3/8	50	32	55	11/16	34.5
14191N-8-8	10	-08	10.3	13/32	3/4 - 16UNF	1/2	54	37	62	7/8	34.5
14191N-10-10	12	-10	12.7	1/2	7/8 - 14UNF	5/8	75	44	65	1	34.5
14191N-12-12	16	-12	15.9	5/8	1 1/16 - 12UNF	3/4	78	56	95	1 1/4	34.5
14191N-16-16	22	-16	22.2	7/8	1 5/16 - 12UNF	1	92	67	110	1 1/2	27.5
14191N-20-20	28	-20	28.6	1 1/8	1 5/8 - 12UNF	1 1/4	102	75	134	2	20.0



10891N – SAE (JIC) 45° female swivel UNF swivel nut

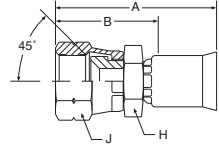

MATERIAL Galvanised steel with transparent Cr(IV)-free plating.
Other materials available on request.

Part No. #	DN size				Connection type		A mm	B mm	H inch	J inch	Max. WP MPa
	mm	inch	Thread size	Tube OD inch							
10891N-6-6	8	-06	7.9	5/16	5/8 - 18UNF	3/8	43	27	5/8	3/4	34.5
10891N-12-12	16	-12	15.9	5/8	1 1/16 - 14UNF	3/4	54	33	1	1 1/4	34.5

17791N – SAE (JIC) 45° female swivel 45° elbow – UNF swivel nut

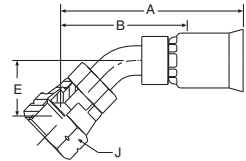

MATERIAL Galvanised steel with transparent Cr(IV)-free plating.
Other materials available on request.

Part No. #	DN size				Connection type		A mm	B mm	E mm	J inch	Max. WP MPa
	mm	inch	Thread size	Tube OD inch							
17791N-6-6	8	-06	7.9	5/16	5/8 - 18UNF	3/8	52	33	10	3/4	34.5
17791N-12-12	16	-12	15.9	5/8	1 1/16 - 14UNF	3/4	78	62	20	1 1/4	34.5

17991N – SAE (JIC) 45° female swivel

90° elbow – UNF swivel nut

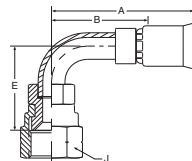

MATERIAL Galvanised steel with transparent Cr(IV)-free plating.
Other materials available on request.

Part No. #	DN size				Connection type		A mm	B mm	E mm	J inch	Max. WP MPa
	mm	inch	Thread size	Tube OD inch							
17991N-6-6	8	-06	7.9	5/16	5/8 - 18UNF	3/8	52	49	30	3/4	34.5
17991N-12-12	16	-12	15.9	5/8	1 1/16 - 14UNF	3/4	74	54	46	1 1/4	34.5

12891N – SAE (JIC) 45° male swivel

UNF male swivel

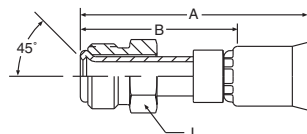

MATERIAL Galvanised steel with transparent Cr(IV)-free plating.
Other materials available on request.

Part No. #	DN size				Connection type		A mm	B mm	J inch	Max. WP MPa
	mm	inch	Thread size	Tube OD inch						
12891N-4-4	5	-04	4.8	3/16	7/16 - 24UNF	1/4	53	38	7/16	19.0
12891N-5-5	6	-05	6.4	1/4	1/2 - 20UNF	5/16	55	40	1/2	17.0
12891N-5-6	8	-06	7.9	5/16	1/2 - 20UNF	3/8	57	40	1/2	17.0
12891N-6-6	8	-06	7.9	5/16	5/8 - 18UNF	3/8	57	40	5/8	15.0
12891N-8-8	10	-08	10.3	13/32	3/4 - 18UNF	1/2	59	41	3/4	14.0
12891N-10-10	12	-10	12.7	1/2	7/8 - 18UNF	5/8	62	44	7/8	12.0
12891N-12-12	16	-12	15.9	5/8	1 1/16 - 16UNF	3/4	64	43	1 1/16	12.0



16791N – SAE (JIC) 45° male swivel 45° elbow – UNF male swivel

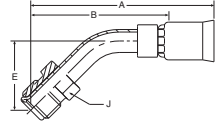

MATERIAL Galvanised steel with transparent Cr(IV)-free plating.
Other materials available on request.

Part No. #	DN size			mm		inch		Connection type		A mm	B mm	E mm	J inch	Max. WP MPa
	mm	inch	mm	inch	Thread size	Tube OD inch								
16791N-4-4	5	-04	4.8	3/16	7/16 - 24UNF	1/4	47	33	16	7/16	19.0			
16791N-5-5	6	-05	6.4	1/4	1/2 - 20UNF	5/16	64	44	18	1/2	17.0			
16791N-6-6	8	-06	7.9	5/16	5/8 - 18UNF	3/8	66	49	24	5/8	15.0			
16791N-8-8	10	-08	10.3	13/32	3/4 - 18UNF	1/2	67	49	23	3/4	14.0			
16791N-10-10	12	-10	12.7	1/2	7/8 - 18UNF	5/8	69	54	26	7/8	12.0			
16791N-12-12	16	-12	15.9	5/8	1 1/16 - 16UNF	3/4	80	64	29	1 1/16	12.0			

16991N – SAE (JIC) 45° male swivel 90° elbow – UNF male swivel

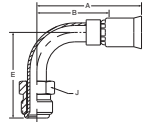

MATERIAL Galvanised steel with transparent Cr(IV)-free plating.
Other materials available on request.



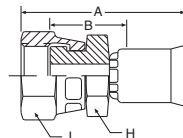

Part No. #	DN size			mm		inch		Connection type		A mm	B mm	E mm	J inch	Max. WP MPa
	mm	inch	mm	inch	Thread size	Tube OD inch								
16991N-4-4	5	-04	4.8	3/16	7/16 - 24UNF	1/4	39	24	30	7/16	19.0			
16991N-5-5	6	-05	6.4	1/4	1/2 - 20UNF	5/16	49	33	42	1/2	17.0			
16991N-5-6	8	-06	7.9	5/16	1/2 - 20UNF	3/8	51	35	42	1/2	17.0			
16991N-6-6	8	-06	7.9	5/16	5/8 - 18UNF	3/8	53	37	43	5/8	15.0			
16991N-8-8	10	-08	10.3	13/32	3/4 - 18UNF	1/2	56	40	47	3/4	14.0			
16991N-10-10	12	-10	12.7	1/2	7/8 - 18UNF	5/8	60	46	55	7/8	12.0			
16991N-12-12	16	-12	15.9	5/8	1 1/16 - 16UNF	3/4	73	52	64	1 1/16	12.0			

1JC91N – O-Lok® ORFS swivel nut

Short version – UNF swivel nut – ISO 12151-1



MATERIAL Galvanised steel with transparent Cr(IV)-free plating.
For stainless steel (AISI 303) please add **C** to the Part No. Example: 1JC91N-8-8**C**.
Other materials available on request.



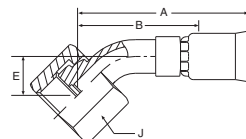

Part No. #	DN size				Connection type Thread size 	A mm	B mm	H inch 	J inch 	Max. WP MPa 
	mm	inch	mm	inch						
1JC91N-4-4	5	-04	4.8	3/16	9/16 - 18UNF	37	16	9/16	11/16	41.0
1JC91N-6-6	8	-06	7.9	5/16	11/16 - 16UNF	39	14	5/8	13/16	41.0
1JC91N-8-8	10	-08	10.3	13/32	13/16 - 16UNF	49	21	3/4	15/16	41.0
1JC91N-10-10	12	-10	12.7	1/2	1 - 14UNF	48	30	7/8	1 1/8	41.0
1JC91N-12-10	12	-10	12.7	1/2	1 3/16 - 12UNF	50	32	15/16	1 1/4	41.0
1JC91N-12-12	16	-12	15.9	5/8	1 3/16 - 12UNF	52	32	15/16	1 3/8	41.0
1JC91N-16-16	16	-12	15.9	5/8	1 7/16 - 12UNF	65	40	1.1	1 5/8	41.0
1JC91N-20-16	22	-16	22.2	7/8	1 11/16 - 12UNF	58	35	1 5/8	1 7/8	27.5
1JC91N-20-20	28	-20	28.6	1 1/8	1 11/16 - 12UNF	68	43	1 5/8	1 7/8	27.5

1J791N – O-Lok® ORFS swivel nut

45° elbow – UNF swivel nut



MATERIAL Galvanised steel with transparent Cr(IV)-free plating.
Other materials available on request.

Part No. #	DN size				Connection type		A mm	B mm	E mm	J inch 	Max. WP MPa 
	mm	inch	mm	inch	Thread size 	Tube OD inch 					
1J791N-4-4	5	-04	4.8	3/16	9/16 - 18UNF	1/4	44	32	10	11/16	41.0
1J791N-4-6	8	-06	7.9	5/16	9/16 - 18UNF	3/8	49	33	10	11/16	41.0
1J791N-6-6	8	-06	7.9	5/16	11/16 - 16UNF	3/8	51	35	11	13/16	41.0
1J791N-8-8	10	-08	10.3	13/32	13/16 - 16UNF	1/2	55	38	15	15/16	41.0
1J791N-10-10	12	-10	12.7	1/2	1 - 14UNF	5/8	63	44	15	1 1/8	41.0
1J791N-12-12	16	-12	15.9	5/8	1 3/16 - 12UNF	3/4	70	49	21	1 3/8	41.0
1J791N-16-16	22	-16	22.2	7/8	1 7/16 - 12UNF	1	89	64	24	1 5/8	41.0



1J991N – O-Lok® ORFS swivel nut

90° elbow – UNF swivel nut

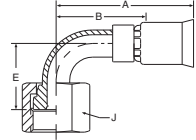

MATERIAL Galvanised steel with transparent Cr(IV)-free plating.
Other materials available on request.

Part No. #	DN size				Connection type		A mm	B mm	E mm	J inch	Max. WP MPa
	mm	inch	Thread size	Tube OD inch							
1J991N-4-4	5	-04	4.8	3/16	9/16 - 18UNF	1/4	45	32	21	11/16	41.0
1J991N-6-6	8	-06	7.9	5/16	11/16 - 16UNF	3/8	47	32	23	13/16	41.0
1J991N-8-8	10	-08	10.3	13/32	13/16 - 16UNF	1/2	53	35	29	15/16	41.0
1J991N-10-10	12	-10	12.7	1/2	1 - 14UNF	5/8	57	38	32	1 1/8	41.0
1J991N-12-12	16	-12	15.9	5/8	1 3/16 - 12UNF	3/4	67	48	47	1 3/8	41.0
1J991N-16-16	22	-16	22.2	7/8	1 7/16 - 12UNF	1	88	65	56	1 5/8	41.0
1J991N-20-20	28	-20	28.6	1 1/8	1 11/16 - 12UNF	1 1/4	99	73	64	1 7/8	27.5

1J191N – O-Lok® ORFS swivel nut

90° elbow – Long drop length – UNF swivel nut

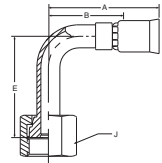

MATERIAL Galvanised steel with transparent Cr(IV)-free plating.
Other materials available on request.

Part No. #	DN size				Connection type		A mm	B mm	E mm	J inch	Max. WP MPa
	mm	inch	Thread size	Tube OD inch							
1J191N-4-4	5	-04	4.8	3/16	9/16 - 18UNF	1/4	42	27	46	11/16	41.0
1J191N-4-5	6	-05	6.4	1/4	9/16 - 18UNF	5/16	45	27	46	11/16	41.0
1J191N-6-5	6	-05	6.4	1/4	11/16 - 16UNF	5/16	49	30	54	13/16	41.0
1J191N-6-6	8	-06	7.9	5/16	11/16 - 16UNF	3/8	49	30	54	13/16	41.0
1J191N-8-6	8	-06	7.9	5/16	13/16 - 16UNF	3/8	51	40	64	15/16	41.0
1J191N-8-8	10	-08	10.3	13/32	13/16 - 16UNF	1/2	55	37	64	15/16	41.0
1J191N-10-10	12	-10	12.7	1/2	1 - 14UNF	5/8	32	40	70	11/16	41.0
1J191N-12-12	16	-12	15.9	5/8	1 3/16 - 12UNF	3/4	67	46	96	1 3/8	41.0
1J191N-16-16	22	-16	22.2	7/8	1 7/16 - 12UNF	1	80	57	114	1 1/2	41.0

1AL91N – A-Lok® connector with clamp ring

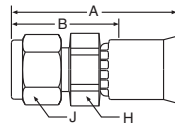

MATERIAL Nipple, swivel nut and ferrule stainless steel (AISI 316);
stainless steel shell (AISI 303)

Part No. #	DN	size	mm	inch	Tube OD inch	A mm	B mm	H inch	J inch	Max. WP MPa
1AL91N-4-4C	5	-04	4.8	3/16	1/4	33	11	1/2	9/16	45.5
1AL91N-4-5C	6	-05	6.4	1/4	5/16	25	11	1/2	9/16	45.5
1AL91N-6-6C	8	-06	7.9	5/16	3/8	39	13	5/8	11/16	36.5
1AL91N-8-8C	10	-08	10.3	13/32	1/2	41	11	13/16	7/8	35.9
1AL91N-12-12C	16	-12	15.9	5/8	3/4	47	13	1 1/8	1 1/8	29.7
1AL91N-16-16C	22	-16	22.2	7/8	1	54	11	1 3/8	1 1/2	31.0

1P691N – CPI® connector with female swivel and clamp ring

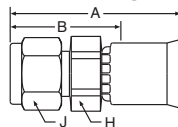

MATERIAL Nipple, swivel nut and ferrule stainless steel (AISI 316);
stainless steel shell (AISI 303)

Part No. #	DN	size	mm	inch	Tube OD inch	A mm	B mm	H inch	J inch	Max. WP MPa
1P691N-4-4C	5	-04	4.8	3/16	1/4	33	11	1/2	9/16	45.5
1P691N-4-5C	6	-05	6.4	1/4	1/4	23	11	1/2	9/16	45.5
1P691N-6-6C	8	-06	7.9	5/16	3/8	39	13	5/8	11/16	36.5
1P691N-8-8C	10	-08	10.3	13/32	1/2	41	11	13/16	7/8	35.9
1P691N-12-12C	16	-12	15.9	5/8	3/4	47	13	1 1/8	1 1/8	29.7
1P691N-16-16C	22	-16	22.2	7/8	1	52	14	1 3/8	1 1/2	31.0



1Q191N – “Ultra Seal” connector

UNF swivel nut

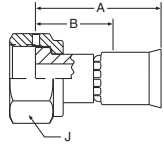

MATERIAL Nipple and swivel nut stainless steel (AISI 316);
stainless steel shell (AISI 303)

Part No. #	DN size				Connection type		A mm	B mm	J inch	Max. WP MPa
	mm	inch	Thread size	Tube OD inch						
1Q191N-4-4C	5	-04	4.8	3/16	9/16 - 20UNF	1/4	41	19	11/16	21.0
1Q191N-6-6C	8	-06	7.9	5/16	3/4 - 20UNF	3/8	46	22	7/8	17.5
1Q191N-8-8C	10	-08	10.3	13/32	7/8 - 20UNF	1/2	41	24	1	14.0
1Q191N-12-12C	16	-12	15.9	5/8	1 5/16 - 20UNF	3/4	49	29	1 1/2	8.3

1TU91N – A-Lok® tube stub end

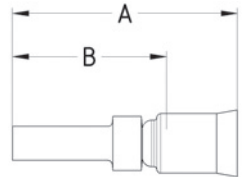

MATERIAL Stainless steel (AISI 303).
Other materials available on request.

Part No. #	DN size				Tube OD	A	B	Max. WP MPa
mm	inch	inch	mm	inch	mm	mm		
1TU91N-4-4C	5	-04	4.8	3/16	1/4	41.4	28.4	21.0
1TU91N-6-6C	8	-06	7.9	5/16	3/8	46.0	30.4	21.0
1TU91N-8-8C	10	-08	10.3	13/32	1/2	57.9	40.8	17.5
1TU91N-12-12C	16	-12	15.9	5/8	3/4	56.9	37.4	14.0
1TU91N-16-16C	22	-16	22.2	7/8	1	69.4	46.5	8.3

1YW91N – A-Lok® metric standpipe

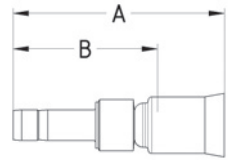

MATERIAL Stainless steel (AISI 303).
Other materials available on request.

Part No. #	DN	size	mm	inch	Tube OD mm	A mm	B mm	Max. WP MPa
1YW91N-6-4C	5	-04	4.8	3/16	6	41.0	28.0	21.0
1YW91N-8-4C	8	-06	7.9	5/16	8	41.9	28.8	21.0
1YW91N-10-6C	10	-08	10.3	13/32	10	47.6	32.0	17.5
1YW91N-12-8C	16	-12	15.9	5/8	12	55.6	38.5	17.5
1YW91N-18-12C	22	-16	22.2	7/8	18	60.2	40.7	14.0



10193N – National Pipe Tapered (NPT) male

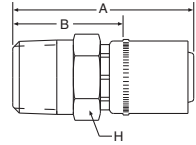

MATERIAL Galvanised steel with transparent Cr(IV)-free plating.
For stainless steel (nipple AISI 316, shell AISI 303)
please add **C** to the Part No. Example: 10193N-8-8**C**.
Other materials available on request.

Part No. #	DN size		mm inch		Connection type	A	B	H	Max. WP MPa
	mm	inch	mm	inch	Thread size	mm	mm	inch	
10193N-8-8	12	-08	12.7	1/2	1/2 - 14NPTF	50	38	7/8	24.0
10193N-8-10	16	-10	15.9	5/8	1/2 - 14NPTF	50	38	1	24.0
10193N-12-12	20	-12	19.0	3/4	3/4 - 14NPTF	66	43	1 1/8	21.0
10193N-16-16	25	-16	25.4	1	1 - 11 1/2NPTF	76	44	1 3/8	17.0
10193N-20-20	32	-20	31.8	1 1/4	1 1/4 - 11 1/2NPTF	79	48	1 11/16	15.0
10193N-24-24	40	-24	38.1	1 1/2	1 1/2 - 11 1/2NPTF	87	52	2	14.0
10193N-32-32	50	-32	50.8	2	2 - 11 1/2NPTF	94	59	2 1/2	14.0

10293N – National Pipe Tapered (NPT) female Rigid

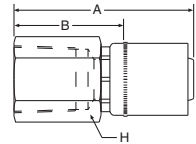

MATERIAL Galvanised steel with transparent Cr(IV)-free plating.
For stainless steel (nipple AISI 316, shell AISI 303)
please add **C** to the Part No. Example: 10293N-8-8**C**.
Other materials available on request.

Part No. #	DN size		mm inch		Connection type	A	B	H	Max. WP MPa
	mm	inch	mm	inch	Thread size	mm	mm	inch	
10293N-8-8	12	-08	12.7	1/2	1/2 - 14NPTF	55	44	7/8	24.0
10293N-12-12	20	-12	19.0	3/4	3/4 - 14NPTF	67	44	1 1/8	21.0
10293N-16-16	25	-16	25.4	1	1 - 11 1/2NPTF	79	51	1 3/8	17.0
10293N-20-20	32	-20	31.8	1 1/4	1 1/4 - 11 1/2NPTF	79	51	1 3/4	15.0
10293N-24-24	40	-24	38.1	1 1/2	1 1/2 - 11 1/2NPTF	91	56	2	14.0
10293N-32-32	50	-32	50.8	2	2 - 11 1/2NPTF	91	56	2 1/2	14.0

10693N – SAE (JIC) 37° female swivel UNF swivel nut

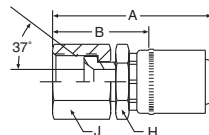

MATERIAL Galvanised steel with transparent Cr(IV)-free plating.
For stainless steel (nipple AISI 316, shell AISI 303)
please add **C** to the Part No. Example: 10693N-8-8**C**.
Other materials available on request.

Part No. #	DN size mm inch				Connection type Thread size	A mm	B mm	H inch	J inch	Max. WP MPa
10693N-8-8	12	-08	12.7	1/2	3/4 - 16UNF	48	35	7/8	7/8	34.5
10693N-10-10	16	-10	15.9	5/8	7/8 - 14UNF	63	41	1	1	34.5
10693N-12-12	20	-12	19.0	3/4	1 1/16 - 12UNF	70	44	1 1/8	1 1/4	34.5
10693N-16-16	25	-16	25.4	1	1 5/16 - 12UNF	78	46	1 3/8	1 1/2	27.5
10693N-20-20	32	-20	31.8	1 1/4	1 5/8 - 12UNF	81	49	1 3/4	1 13/16	20.0
10693N-24-24	40	-24	38.1	1 1/2	1 7/8 - 12UNF	91	57	2	2 1/8	17.0
10693N-32-32	50	-32	50.8	2	2 1/2 - 12UNF	98	62	2 1/2	2 3/4	17.0

1JC93N – O-Lok® ORFS swivel nut Short version – UNF swivel nut – ISO 12151-1

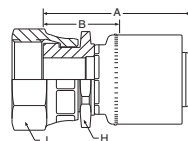

MATERIAL Galvanised steel with transparent Cr(IV)-free plating.
For stainless steel (nipple AISI 316, shell AISI 303)
please add **C** to the Part No. Example: 1JC93N-16-16**C**.
Other materials available on request.

Part No. #	DN size mm inch				Connection type Thread size		A mm	B mm	H inch	J inch	Max. WP MPa
						Tube OD inch					
1JC93N-16-16	25	-16	25.4	1	1 7/16 - 12UNF	1	66	35	1 3/8	1 5/8	41.0
1JC93N-20-20	32	-20	31.8	1 1/4	1 11/16 - 12UNF	1 1/4	65	33	1 5/16	1 7/8	27.5

1J793N – O-Lok® ORFS swivel nut

45° elbow – UNF swivel nut

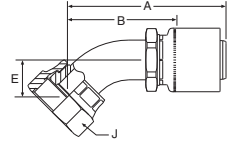

MATERIAL Galvanised steel with transparent Cr(IV)-free plating.
For stainless steel (AISI 316) please add **C** to the Part No. Example: 1J793N-16-16**C**.
Other materials available on request.

Part No. #	DN size				Connection type		A mm	B mm	E mm	J inch	Max. WP MPa
	mm	inch	Thread size	Tube OD inch							
1J793N-16-16	25	-16	25.4	1	1 7/16 - 12UNF	1	102	70	24	1 5/8	41.0
1J793N-20-20	32	-20	31.8	1 1/4	1 11/16 - 12UNF	1 1/4	106	75	25	1 7/8	27.5

1J993N – O-Lok® ORFS swivel nut

90° elbow – UNF swivel nut

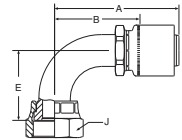

MATERIAL Galvanised steel with transparent Cr(IV)-free plating.
For stainless steel (AISI 316) please add **C** to the Part No. Example: 1J993N-16-16**C**.
Other materials available on request.

Part No. #	DN size				Connection type		A mm	B mm	E mm	J inch	Max. WP MPa
	mm	inch	Thread size	Tube OD inch							
1J993N-16-16	25	-16	25.4	1	1 7/16 - 12UNF	1	101	70	56	1 5/8	41.0
1J993N-20-20	32	-20	31.8	1 1/4	1 11/16 - 12UNF	1 1/4	108	76	64	1 7/8	27.5

1C3PC – Metric female swivel 24°/60°

Light series – Metric swivel nut

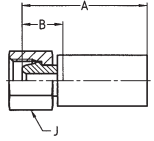

MATERIAL Galvanised steel with transparent Cr(IV)-free plating.
Other materials available on request.

Part No. #	DN size				Connection type		A mm	B mm	J mm	Max. WP MPa
	mm	inch	Thread size	Tube OD mm						
1C3PC-8-04	6	-04	6.4	1/4	M14x1.5	8	46	18	17	25.0
1C3PC-10-04	6	-04	6.4	1/4	M16x1.5	10	46	18	19	25.0
1C3PC-10-05	8	-05	7.9	5/16	M16x1.5	10	46	18	19	25.0
1C3PC-10-06	10	-06	9.5	3/8	M16x1.5	10	49	20	22	25.0
1C3PC-12-06	10	-06	9.5	3/8	M18x1.5	12	48	19	22	25.0
1C3PC-12-08	12	-08	12.7	1/2	M18x1.5	12	52	20	24	25.0
1C3PC-15-08	12	-08	12.7	1/2	M22x1.5	15	51	20	27	25.0



1CAPC – Metric female swivel 24° with O-ring

Light series – Metric swivel nut – ISO 12151-2

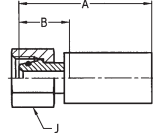

MATERIAL Galvanised steel with transparent Cr(IV)-free plating.
Other materials available on request.

Part No. #	DN size				Connection type		A mm	B mm	J mm	Max. WP MPa
	mm	inch	Thread size	Tube OD mm						
1CAPC-6-04	6	-04	6.4	1/4	M12x1.5	6	48	20	17	31.5
1CAPC-8-04	6	-04	6.4	1/4	M14x1.5	8	51	23	17	42.5
1CAPC-10-04	6	-04	6.4	1/4	M16x1.5	10	50	22	19	40.0
1CAPC-10-05	8	-05	7.9	5/16	M16x1.5	10	50	22	19	40.0
1CAPC-12-05	8	-05	7.9	5/16	M18x1.5	12	50	22	22	35.0
1CAPC-10-06	10	-06	9.5	3/8	M16x1.5	10	51	22	22	40.0
1CAPC-12-06	10	-06	9.5	3/8	M18x1.5	12	52	23	22	35.0
1CAPC-15-08	12	-08	12.7	1/2	M22x1.5	15	59	28	27	31.5
1CAPC-18-10	16	-10	15.9	5/8	M26x1.5	18	56	25	32	31.5
1CAPC-22-12	20	-12	19.0	3/4	M30x2	22	62	27	36	28.0
1CAPC-28-16	25	-16	25.4	1	M36x2	28	64	29	41	21.0

1C9PC – Metric female swivel 24° with O-ring

Heavy series – Metric swivel nut – ISO 12151-2

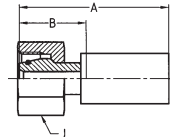

MATERIAL Galvanised steel with transparent Cr(IV)-free plating.
Other materials available on request.

Part No. #	DN size				Connection type		A mm	B mm	J mm	Max. WP MPa
	mm	inch	Thread size	Tube OD mm						
1C9PC-10-04	6	-04	6.4	1/4	M18x1.5	10	55	27	22	63.0
1C9PC-12-05	8	-05	7.9	5/16	M20x1.5	12	56	28	24	63.0
1C9PC-12-06	10	-06	9.5	3/8	M20x1.5	12	54	25	24	63.0
1C9PC-14-06	10	-06	9.5	3/8	M22x1.5	14	59	30	27	63.0
1C9PC-16-08	12	-08	12.7	1/2	M24x1.5	16	65	34	30	42.0
1C9PC-20-10	16	-10	15.9	5/8	M30x2	20	68	37	36	42.0

1CEPC – Metric female swivel 24° with O-ring

45° elbow – Light series – Metric swivel nut – ISO 12151-2

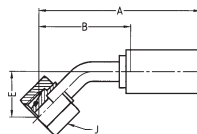

MATERIAL Galvanised steel with transparent Cr(IV)-free plating.
Other materials available on request.

Part No. #	DN				Connection type		A mm	B mm	E mm	J mm	Max. WP MPa
	size	mm	inch	Thread size	Tube OD mm						
1CEPC-6-04	6	-04	6.4	1/4	M12x1.5	6	72	43	23	17	31.5
1CEPC-8-04	6	-04	6.4	1/4	M14x1.5	8	72	43	23	17	42.5
1CEPC-10-05	8	-05	7.9	5/16	M16x1.5	10	72	43	20	19	40.0
1CEPC-10-06	10	-06	9.5	3/8	M16x1.5	10	70	40	18	19	40.0
1CEPC-12-06	10	-06	9.5	3/8	M18x1.5	12	70	40	18	22	35.0
1CEPC-15-08	12	-08	12.7	1/2	M22x1.5	15	83	51	21	27	31.5
1CEPC-18-10	16	-10	15.9	5/8	M26x1.5	18	96	65	27	32	31.5
1CEPC-22-12	20	-12	19.0	3/4	M30x2	22	114	79	32	36	28.0
1CEPC-28-16	25	-16	25.4	1	M36x2	28	112	77	35	41	21.0

10CPC – Metric female swivel 24° with O-ring

45° elbow – Heavy series – Metric swivel nut – ISO 12151-2

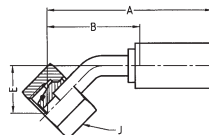

MATERIAL Galvanised steel with transparent Cr(IV)-free plating.
Other materials available on request.

Part No. #	DN				Connection type		A mm	B mm	E mm	J mm	Max. WP MPa
	size	mm	inch	Thread size	Tube OD mm						
10CPC-10-04	6	-04	6.4	1/4	M18x1.5	10	74	45	24	22	63.0
10CPC-12-05	8	-05	7.9	5/16	M20x1.5	12	71	42	20	24	63.0
10CPC-14-06	10	-06	9.5	3/8	M22x1.5	14	70	40	19	27	63.0
10CPC-16-08	12	-08	12.7	1/2	M24x1.5	16	85	53	23	30	42.0
10CPC-20-10	16	-10	15.9	5/8	M30x2	20	99	68	29	36	42.0

1CFPC – Metric female swivel 24° with O-ring 90° elbow – Light series – Metric swivel nut – ISO 12151-2

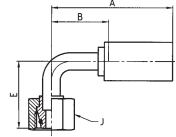

MATERIAL Galvanised steel with transparent Cr(IV)-free plating.
Other materials available on request.

Part No. #	DN size				Connection type		A mm	B mm	E mm	J mm	Max. WP MPa
	mm	inch	Thread size	Tube OD mm							
1CFPC-6-04	6	-04	6.4	3/8	M12x1.5	6	59	30	33	17	31.5
1CFPC-8-04	6	-04	6.4	1/4	M14x1.5	8	59	30	33	17	42.5
1CFPC-10-05	8	-05	7.9	5/16	M16x1.5	10	59	30	33	19	40.0
1CFPC-10-06	10	-06	9.5	3/8	M16x1.5	10	60	30	35	19	40.0
1CFPC-12-06	10	-06	9.5	3/8	M18x1.5	12	60	30	35	22	35.0
1CFPC-15-08	12	-08	12.7	1/2	M22x1.5	15	74	42	42	27	31.5
1CFPC-18-10	16	-10	15.9	5/8	M26x1.5	18	84	53	52	32	31.5
1CFPC-22-12	20	-12	19.0	3/4	M30x2	22	100	65	62	36	28.0

11CPC – Metric female swivel 24° with O-ring 90° elbow – Heavy series – Metric swivel nut – ISO 12151-2

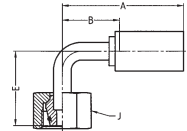

MATERIAL Galvanised steel with transparent Cr(IV)-free plating.
Other materials available on request.

Part No. #	DN size				Connection type		A mm	B mm	E mm	J mm	Max. WP MPa
	mm	inch	Thread size	Tube OD mm							
11CPC-6-04	6	-04	6.4	1/4	M14x1.5	6	59	30	29	17	63.0
11CPC-10-04	6	-04	6.4	1/4	M18x1.5	10	59	30	36	22	63.0
11CPC-12-05	8	-05	7.9	5/16	M20x1.5	12	59	30	36	24	63.0
11CPC-14-06	10	-06	9.5	3/8	M22x1.5	14	60	30	36	27	63.0
11CPC-16-08	12	-08	12.7	1/2	M24x1.5	16	74	42	44	30	42.0
11CPC-20-10	16	-10	15.9	5/8	M30x2	20	84	53	61	36	42.0

1D0PC – Metric male 24°

Light series – ISO 12151-2

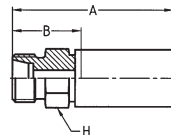

MATERIAL Galvanised steel with transparent Cr(IV)-free plating.
Other materials available on request.

Part No. #	DN size mm inch				Connection type		A mm	B mm	H mm	Max. WP MPa
	Thread size	Tube OD mm	mm	inch	mm	mm				
1D0PC-6-04	6	-04	6.4	1/4	M12x1.5	6	51	23	14	25.0
1D0PC-8-04	6	-04	6.4	1/4	M14x1.5	8	51	23	14	42.5
1D0PC-8-05	8	-05	7.9	5/16	M14x1.5	8	53	25	17	42.5
1D0PC-10-05	8	-05	7.9	5/16	M16x1.5	10	54	26	17	40.0
1D0PC-12-06	10	-06	9.5	3/8	M18x1.5	12	56	27	19	40.0
1D0PC-10-06	10	-06	9.5	3/8	M16x1.5	10	57	27	17	35.0
1D0PC-15-06	10	-06	9.5	3/8	M22x1.5	15	57	28	22	31.0
1D0PC-15-08	12	-08	12.7	1/2	M22x1.5	15	59	28	22	31.0
1D0PC-18-10	16	-10	15.9	5/8	M26x1.5	18	59	28	27	28.0
1D0PC-22-12	20	-12	19.0	3/4	M30x2	22	67	32	30	28.0
1D0PC-28-16	25	-16	25.4	1	M36x2	28	67	32	36	21.0

1D2PC – Metric male 24°

Heavy series – ISO 12151-2

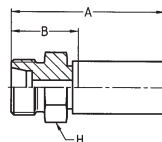

MATERIAL Galvanised steel with transparent Cr(IV)-free plating.
Other materials available on request.

Part No. #	DN size mm inch				Connection type		A mm	B mm	H mm	Max. WP MPa
	Thread size	Tube OD mm	mm	inch	mm	mm				
1D2PC-8-04	6	-04	6.4	1/4	M16x1.5	8	56	28	17	63.0
1D2PC-10-04	6	-04	6.4	1/4	M18x1.5	10	55	27	19	63.0
1D2PC-12-05	8	-05	7.9	5/16	M20x1.5	12	55	27	22	63.0
1D2PC-14-05	8	-05	7.9	5/16	M22x1.5	14	57	29	22	63.0
1D2PC-14-06	10	-06	9.5	3/8	M22x1.5	14	59	30	22	63.0
1D2PC-12-06	10	-06	9.5	3/8	M22x1.5	12	57	28	22	63.0
1D2PC-16-08	12	-08	12.7	1/2	M24x1.5	16	61	30	24	42.0
1D2PC-20-10	16	-10	15.9	5/8	M30x2	20	65	34	30	42.0
1D2PC-25-12	20	-12	19.0	3/4	M36x2	25	71	36	36	42.0
1D2PC-30-16	25	-16	25.4	1	M42x2	30	73	38	46	42.0



11DPC – Metric standpipe

Light series

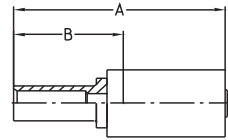

MATERIAL Galvanised steel with transparent Cr(IV)-free plating.
Other materials available on request.

Part No. #	DN size				Tube OD mm	A mm	B mm	Max. WP MPa
	mm	inch	mm	inch				
11DPC-8-04	6	-04	6.4	1/4	8	58	30	25.0
11DPC-10-05	8	-05	7.9	5/16	10	59	31	25.0
11DPC-10-06	10	-06	9.5	3/8	10	79	32	25.0
11DPC-12-06	10	-06	9.5	3/8	12	79	32	25.0
11DPC-15-08	12	-08	12.7	1/2	15	65	34	25.0
11DPC-18-10	16	-10	15.9	5/8	18	66	35	16.0
11DPC-22-12	20	-12	19.0	3/4	22	72	37	16.0
11DPC-28-16	25	-16	25.4	1	28	74	39	10.0

NOTE: Not recommended for new constructions. Please refer to end connections C3 or CA.

192PC – BSP female swivel 60° cone

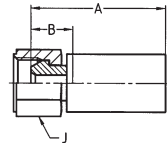

MATERIAL Galvanised steel with transparent Cr(IV)-free plating.
Other materials available on request.

Part No. #	DN size				Connection type Thread size	A mm	B mm	J mm	Max. WP MPa
	mm	inch	mm	inch					
192PC-4-04	6	-04	6.4	1/4	G 1/4	45	17	17	63.0
192PC-6-05	8	-05	7.9	5/16	G 3/8	45	17	19	55.0
192PC-6-06	10	-06	9.5	3/8	G 3/8	48	19	22	55.0
192PC-8-06	10	-06	9.5	3/8	G 1/2	48	19	27	43.0
192PC-8-08	12	-08	12.7	1/2	G 1/2	53	21	27	43.0
192PC-12-10	16	-10	15.9	5/8	G 3/4	50	19	32	35.0
192PC-12-12	20	-12	19.0	3/4	G 3/4	56	21	32	35.0
192PC-16-12	20	-12	19.0	3/4	G 1	56	22	41	28.0
192PC-16-16	25	-16	25.4	1	G 1	57	22	41	28.0
192PC-20-16	25	-16	25.4	1	G 1 1/4	58	24	50	21.0

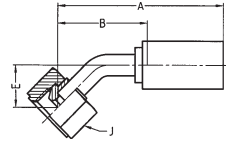
**1B1PC – BSP female swivel 60° cone
45° elbow**

MATERIAL Galvanised steel with transparent Cr(IV)-free plating.
Other materials available on request.

Part No. #	DN size mm inch				Connection type	A mm	B mm	E mm	J mm	Max. WP MPa
	size mm	inch	Thread size	mm						
1B1PC-4-04	6	-04	6.4	1/4	G 1/4	70	41	21	17	63.0
1B1PC-6-05	8	-05	7.9	5/16	G 3/8	68	39	17	22	55.0
1B1PC-6-06	10	-06	9.5	3/8	G 3/8	66	36	14	22	55.0
1B1PC-8-06	10	-06	9.5	3/8	G 1/2	67	37	15	27	43.0
1B1PC-8-08	12	-08	12.7	1/2	G 1/2	86	54	18	27	43.0
1B1PC-12-10	16	-10	15.9	5/8	G 3/4	99	68	26	32	35.0
1B1PC-12-12	20	-12	19.0	3/4	G 3/4	117	82	30	32	35.0
1B1PC-16-16	25	-16	25.4	1	G 1	120	85	43	41	28.0
1B1PC-20-16	25	-16	25.4	1	G 1 1/4	116	81	34	50	21.0

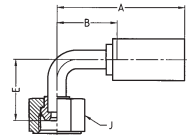
**1B2PC – BSP female swivel 60° cone
90° elbow**

MATERIAL Galvanised steel with transparent Cr(IV)-free plating.
Other materials available on request.

Part No. #	DN size mm inch				Connection type	A mm	B mm	E mm	J mm	Max. WP MPa
	size mm	inch	Thread size	mm						
1B2PC-4-04	6	-04	6.4	1/4	G 1/4	59	30	30	17	63.0
1B2PC-6-05	8	-05	7.9	5/16	G 3/8	59	30	28	22	55.0
1B2PC-6-06	10	-06	9.5	3/8	G 3/8	60	30	30	22	55.0
1B2PC-8-06	10	-06	9.5	3/8	G 1/2	60	30	31	27	43.0
1B2PC-8-08	12	-08	12.7	1/2	G 1/2	74	42	38	27	43.0
1B2PC-12-10	16	-10	15.9	5/8	G 3/4	84	53	50	32	35.0
1B2PC-12-12	20	-12	19.0	3/4	G 3/4	100	65	60	32	35.0
1B2PC-20-16	25	-16	25.4	1	G 1 1/4	100	65	70	50	21.0



1U0PC – BSP female swivel (ballnose)

BSP swivel nut

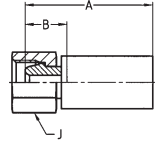

MATERIAL Galvanised steel with transparent Cr(IV)-free plating.
Other materials available on request.

Part No. #	DN size				Connection type Thread size	A mm	B mm	J mm	Max. WP MPa
	mm	inch	mm	inch					
1U0PC-4-04	6	-04	6.4	1/4	G 1/4	45	17	17	63.0
1U0PC-6-05	8	-05	7.9	5/16	G 3/8	45	17	19	55.0
1U0PC-6-06	10	-06	9.5	3/8	G 3/8	48	19	22	55.0
1U0PC-8-06	10	-06	9.5	3/8	G 1/2	48	19	27	43.0
1U0PC-8-08	12	-08	12.7	1/2	G 1/2	53	21	27	43.0
1U0PC-12-10	16	-10	15.9	5/8	G 3/4	50	19	32	35.0
1U0PC-12-12	20	-12	19.0	3/4	G 3/4	56	21	32	35.0
1U0PC-16-12	20	-12	19.0	3/4	G 1	56	22	41	25.0
1U0PC-16-16	25	-16	25.4	1	G 1	57	22	41	25.0
1U0PC-20-16	25	-16	25.4	1	G 1 1/4	58	24	50	21.0

1D9PC – BSP male

DIN 3852 Form A

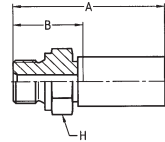



MATERIAL Galvanised steel with transparent Cr(IV)-free plating.
Other materials available on request.

Part No. #	DN size				Connection type Thread size	A mm	B mm	H mm	Max. WP MPa
	mm	inch	mm	inch					
1D9PC-4-04	6	-04	6.4	1/4	G 1/4	57	29	19	63.0
1D9PC-6-05	8	-05	7.9	5/16	G 3/8	58	29	22	55.0
1D9PC-6-06	10	-06	9.5	3/8	G 3/8	60	30	22	55.0
1D9PC-8-06	10	-06	9.5	3/8	G 1/2	62	33	27	43.0
1D9PC-8-08	12	-08	12.7	1/2	G 1/2	64	33	27	43.0
1D9PC-12-10	16	-10	15.9	5/8	G 3/4	66	35	32	35.0
1D9PC-12-12	20	-12	19.0	3/4	G 3/4	72	37	32	35.0
1D9PC-16-12	20	-12	19.0	3/4	G 1	74	39	41	28.0
1D9PC-20-16	25	-16	25.4	1	G 1 1/4	76	41	50	21.0

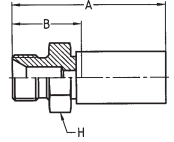
13BPC – BSP male 60° flare



MATERIAL Galvanised steel with transparent Cr(IV)-free plating.
Other materials available on request.

Part No. #	DN size				Connection type Thread size 	A mm	B mm	H mm	Max. WP MPa 
	mm	inch	mm	inch					
13BPC-4-04	6	-04	6.4	1/4	G 1/4	54	26	17	63.0
13BPC-6-05	8	-05	7.9	5/16	G 3/8	57	28	22	55.0
13BPC-6-06	10	-06	9.5	3/8	G 3/8	59	29	22	55.0
13BPC-8-06	10	-06	9.5	3/8	G 1/2	64	34	24	43.0
13BPC-8-08	12	-08	12.7	1/2	G 1/2	66	34	24	43.0
13BPC-12-10	16	-10	15.9	5/8	G 3/4	69	38	32	35.0
13BPC-12-12	20	-12	19.0	3/4	G 3/4	73	38	32	35.0
13BPC-16-12	20	-12	19.0	3/4	G 1	82	47	36	28.0
13BPC-16-16	25	-16	25.4	1	G 1	82	47	36	28.0
13BPC-20-16	25	-16	25.4	1	G 1 1/4	84	49	50	21.0



101PC – National Pipe Tapered (NPT) male

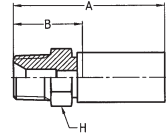

MATERIAL Galvanised steel with transparent Cr(IV)-free plating.
Other materials available on request.

Part No. #	DN size				Connection type Thread size 	A mm	B mm	H mm	Max. WP MPa
	mm	inch	mm	inch					
101PC-4-04	6	-04	6.4	1/4	1/4 - 18NPTF	55	27	14	34.5
101PC-6-04	6	-04	6.4	1/4	3/8 - 18NPTF	57	29	19	27.5
101PC-6-05	8	-05	7.9	5/16	3/8 - 18NPTF	57	29	19	27.5
101PC-4-06	10	-06	9.5	3/8	1/4 - 18NPTF	57	28	14	34.5
101PC-6-06	10	-06	9.5	3/8	3/8 - 18NPTF	59	30	19	27.5
101PC-8-06	10	-06	9.5	3/8	1/2 - 14NPTF	64	35	22	24.0
101PC-6-08	12	-08	12.7	1/2	3/8 - 18NPTF	61	30	19	27.5
101PC-8-08	12	-08	12.7	1/2	1/2 - 14NPTF	66	35	22	24.0
101PC-12-10	16	-10	15.9	5/8	3/4 - 14NPTF	66	35	27	21.0
101PC-12-12	20	-12	19.0	3/4	3/4 - 14NPTF	70	35	27	21.0
101PC-16-12	20	-12	19.0	3/4	1 - 11 1/2NPTF	77	42	36	17.0
101PC-16-16	25	-16	25.4	1	1 - 11 1/2NPTF	77	42	36	17.0

103PC – SAE (JIC) 37° male

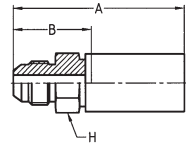

MATERIAL Galvanised steel with transparent Cr(IV)-free plating.
Other materials available on request.



Part No. #	DN size				Connection type Thread size 	A mm	B mm	H mm	Max. WP MPa
	mm	inch	mm	inch					
103PC-5-04	6	-04	6.4	1/4	1/2 - 20UNF	57	29	14	41.0
103PC-6-04	6	-04	6.4	1/4	9/16 - 18UNF	57	29	17	34.5
103PC-6-05	8	-05	7.9	5/16	9/16 - 18UNF	57	29	17	34.5
103PC-8-06	10	-06	9.5	3/8	3/4 - 16UNF	62	33	22	34.5
103PC-10-08	12	-08	12.7	1/2	7/8 - 14UNF	70	38	24	34.5
103PC-12-10	16	-10	15.9	5/8	1 1/16 - 12UNF	71	40	30	34.5
103PC-16-12	20	-12	19.0	3/4	1 5/16 - 12UNF	76	41	36	27.5
103PC-20-16	25	-16	25.4	1	1 5/8 - 12UNF	78	43	46	20.0

PC-series

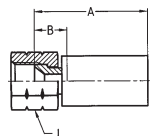
106PC – SAE (JIC) 37° female swivel UNF swivel nut





MATERIAL Galvanised steel with transparent Cr(IV)-free plating.
Other materials available on request.

Part No. #	DN size mm inch				Connection type	A mm	B mm	J mm	Max. WP MPa
					Thread size 				
106PC-4-04	6	-04	6.4	1/4	7/16 - 20UNF	43	15	17	41.0
106PC-5-04	6	-04	6.4	1/4	1/2 - 20UNF	43	15	19	41.0
106PC-6-05	8	-05	7.9	5/16	9/16 - 18UNF	45	17	19	34.5
106PC-6-06	10	-06	9.5	3/8	9/16 - 18UNF	47	18	19	34.5
106PC-8-06	10	-06	9.5	3/8	3/4 - 16UNF	48	19	24	34.5
106PC-10-08	12	-08	12.7	1/2	7/8 - 20UNF	49	18	27	34.5
106PC-12-10	16	-10	15.9	5/8	1 1/16 - 12UNF	50	19	32	34.5
106PC-16-12	20	-12	19.0	3/4	1 5/16 - 12UNF	56	22	41	27.5
106PC-20-16	25	-16	25.4	1	1 5/8 - 12UNF	56	22	50	20.0

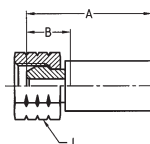
107PC – NPSM female swivel



MATERIAL Galvanised steel with transparent Cr(IV)-free plating.
For fittings as mentioned above, but with stainless steel nipple
(AISI 303), please add **C2W** to the Part No. Example: 107PC-4-04 **C2W**.
Other materials available on request.

Part No. #	DN size mm inch				Connection type	A mm	B mm	J mm	Max. WP MPa
					Thread size 				
107PC-4-03	5	-03	4.8	3/16	1/4 - 18NPSM	44	19	17	34.5
107PC-2-03	5	-03	4.8	3/16	1/8 - 27NPSM	47	21	17	34.5
107PC-4-04	6	-04	6.4	1/4	1/4 - 18NPSM	47	19	19	34.5
107PC-6-05	8	-05	7.9	5/16	3/8 - 18NPSM	48	20	22	27.5
107PC-6-06	10	-06	9.5	3/8	3/8 - 18NPSM	50	21	22	27.5
107PC-8-08	12	-08	12.7	1/2	1/2 - 14NPSM	50	19	27	24.0
107PC-12-10	16	-10	15.9	5/8	3/4 - 14NPSM	53	22	32	21.0
107PC-12-12	20	-12	19.0	3/4	3/4 - 14NPSM	59	24	32	21.0



137PC – SAE (JIC) 37° female swivel

45° elbow – UNF swivel nut

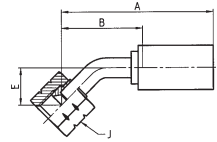

MATERIAL Galvanised steel with transparent Cr(IV)-free plating.
Other materials available on request.

Part No. #	DN size				Connection type Thread size	A mm	B mm	E mm	J mm	Max. WP MPa
	mm	inch	mm	inch						
137PC-5-04	6	-04	6.4	1/4	1/2 - 20UNF	70	41	21	19	41.0
137PC-6-05	8	-05	7.9	5/16	9/16 - 18UNF	67	38	16	19	34.5
137PC-10-08	12	-08	12.7	1/2	7/8 - 14UNF	81	49	19	27	34.5
137PC-12-10	16	-10	15.9	5/8	1 1/16 - 12UNF	96	65	27	32	34.5
137PC-16-12	20	-12	19.0	3/4	1 5/16 - 12UNF	114	79	32	41	27.5
137PC-20-16	25	-16	25.4	1	1 5/8 - 12UNF	113	78	36	50	20.0

139PC – SAE (JIC) 37° female swivel

90° elbow – UNF swivel nut

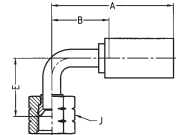

MATERIAL Galvanised steel with transparent Cr(IV)-free plating.
Other materials available on request.

Part No. #	DN size				Connection type Thread size	A mm	B mm	E mm	J mm	Max. WP MPa
	mm	inch	mm	inch						
139PC-5-04	6	-04	6.4	1/4	1/2 - 20 UNF	59	30	31	19	41.0
139PC-6-05	8	-05	7.9	5/16	9/16 - 18 UNF	59	30	28	19	34.5
139PC-8-06	10	-06	9.5	3/8	3/4 - 16 UNF	60	30	31	24	34.5
139PC-10-08	12	-08	12.7	1/2	7/8 - 14 UNF	74	42	39	27	34.5
139PC-12-10	16	-10	15.9	5/8	1 1/16 - 12 UNF	84	53	52	32	34.5
139PC-16-12	20	-12	19.0	3/4	1 5/16 - 12 UNF	100	65	62	41	27.5
139PC-20-16	25	-16	25.4	1	1 5/8 - 12 UNF	100	65	73	50	20.0

PC series

1C3YX – Metric female swivel 24°/60°

Light series – Metric swivel nut

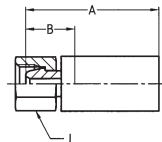

MATERIAL

Galvanised steel with transparent Cr(IV)-free plating.
For fittings as mentioned above, but with stainless steel nipple
(AISI 303), please add **C2W** to the Part No. Example: 1C3YX-6-03 **C2W**.
Other materials available on request.

Part No. #	DN size mm inch				Connection type	A mm	B mm	J mm	Max. WP MPa
	DN	size	mm	inch	Thread size				
1C3YX-6-03	5	-03	4.8	3/16	M12x1.5	43	18	14	25.0
1C3YX-8-03	5	-03	4.8	3/16	M14x1.5	43	18	17	25.0
1C3YX-10-03	5	-03	4.8	3/16	M16x1.5	43	18	19	25.0
1C3YX-8-04	6	-04	6.4	1/4	M14x1.5	46	18	17	25.0
1C3YX-10-04	6	-04	6.4	1/4	M16x1.5	46	18	19	25.0
1C3YX-10-05	8	-05	7.9	5/16	M16x1.5	46	18	19	25.0
1C3YX-10-06	10	-06	9.5	3/8	M16x1.5	49	20	22	25.0
1C3YX-12-06	10	-06	9.5	3/8	M18x1.5	48	19	22	25.0
1C3YX-12-08	12	-08	12.7	1/2	M18x1.5	52	20	24	25.0
1C3YX-15-08	12	-08	12.7	1/2	M22x1.5	51	20	27	25.0
1C3YX-18-10	16	-10	15.9	5/8	M26x1.5	51	20	32	16.0
1C3YX-18-12	20	-12	19.0	3/4	M26x1.5	57	22	32	16.0
1C3YX-22-12	20	-12	19.0	3/4	M30x2	57	23	36	16.0
1C3YX-28-16	25	-16	25.4	1	M36x2	59	25	41	10.0



1CAYX – Metric female swivel 24° with O-ring

Light series – Metric swivel nut – ISO 12151-2

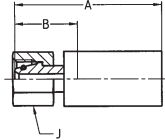

MATERIAL Galvanised steel with transparent Cr(IV)-free plating.
Other materials available on request.

Part No. #	DN size			Connection type		A mm	B mm	J mm	Max. WP MPa
	mm	inch	Thread size						
1CAYX-6-03	5	-03	4.8	3/16	M12x1.5	45	20	14	31.5
1CAYX-8-04	6	-04	6.4	1/4	M14x1.5	50	23	17	42.5
1CAYX-10-04	6	-04	6.4	1/4	M16x1.5	50	22	19	40.0
1CAYX-10-05	8	-05	7.9	5/16	M16x1.5	50	22	19	40.0
1CAYX-12-06	10	-06	9.5	3/8	M18x1.5	50	23	22	35.0
1CAYX-15-08	12	-08	12.7	1/2	M22x1.5	59	28	27	31.5
1CAYX-18-10	16	-10	15.9	5/8	M26x1.5	56	25	32	31.5
1CAYX-22-12	20	-12	19.0	3/4	M30x2	62	27	36	28.0
1CAYX-28-16	25	-16	25.4	1	M36x2	64	29	41	21.0

1C9YX – Metric female swivel 24° with O-ring

Heavy series – Metric swivel nut – ISO 12151-2

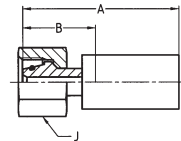

MATERIAL Galvanised steel with transparent Cr(IV)-free plating.
Other materials available on request.

Part No. #	DN size			Connection type		A mm	B mm	J mm	Max. WP MPa
	mm	inch	Thread size	Tube OD mm					
1C9YX-8-03	5	-03	4.8	3/16	M16x1.5	8	47	22	63.0
1C9YX-8-04	6	-04	6.4	1/4	M16x1.5	8	51	24	63.0
1C9YX-10-04	6	-04	6.4	1/4	M18x1.5	10	54	27	63.0
1C9YX-12-05	8	-05	7.9	5/16	M20x1.5	12	56	28	63.0
1C9YX-14-06	10	-06	9.5	3/8	M22x1.5	14	57	30	63.0
1C9YX-16-08	12	-08	12.7	1/2	M24x1.5	16	65	34	42.0
1C9YX-20-10	16	-10	15.9	5/8	M30x2	20	68	37	42.0
1C9YX-25-12	20	-12	19.0	3/4	M36x2	25	77	42	42.0
1C9YX-30-16	25	-16	25.4	1	M42x2	30	79	45	42.0

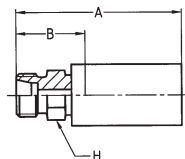

1D0YX – Metric male 24°
Light series – ISO 12151-2

MATERIAL Galvanised steel with transparent Cr(IV)-free plating.
Other materials available on request.

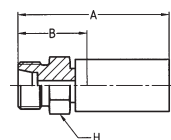
Part No. #	DN size				Connection type Thread size 	A mm	B mm	H mm	Max. WP MPa
	mm	inch	mm	inch					
1D0YX-6-03	5	-03	4.8	3/16	M12x1.5	48	23	12	25.0
1D0YX-8-04	6	-04	6.4	1/4	M14x1.5	50	23	14	42.5
1D0YX-10-05	8	-05	7.9	5/16	M16x1.5	54	26	17	40.0
1D0YX-12-06	10	-06	9.5	3/8	M18x1.5	54	27	19	35.0
1D0YX-15-08	12	-08	12.7	1/2	M22x1.5	59	28	22	31.0
1D0YX-18-10	16	-10	15.9	5/8	M26x1.5	59	28	27	28.0
1D0YX-22-12	20	-12	19.0	3/4	M30x2	67	32	30	28.0
1D0YX-28-16	25	-16	25.4	1	M36x2	67	32	36	21.0

1D2YX – Metric male 24°
Heavy series – ISO 12151-2

MATERIAL Galvanised steel with transparent Cr(IV)-free plating.
Other materials available on request.

Part No. #	DN size				Connection type		A mm	B mm	H mm	Max. WP MPa
	mm	inch	mm	inch	Thread size 	Tube OD mm 				
1D2YX-8-03	5	-03	4.8	3/16	M16x1.5	8	50	25	17	63.0
1D2YX-10-04	6	-04	6.4	1/4	M18x1.5	10	54	27	19	63.0
1D2YX-12-05	8	-05	7.9	5/16	M20x1.5	12	55	27	22	63.0
1D2YX-14-06	10	-06	9.5	3/8	M22x1.5	14	57	30	22	63.0
1D2YX-16-08	12	-08	12.7	1/2	M24x1.5	16	61	30	24	42.0
1D2YX-20-10	16	-10	15.9	5/8	M30x2	20	65	34	30	42.0
1D2YX-25-12	20	-12	19.0	3/4	M36x2	25	71	36	36	42.0
1D2YX-30-16	25	-16	25.4	1	M42x2	30	73	38	46	42.0



11DYX – Metric standpipe

Light series

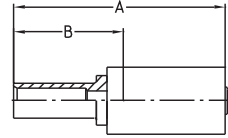

MATERIAL Galvanised steel with transparent Cr(IV)-free plating.
Other materials available on request.

Part No. #	DN size				Tube OD mm	A mm	B mm	Max. WP MPa
	mm	inch	mm	inch				
11DYX-6-03	5	-03	4.8	3/16	6	55	27	25.0
11DYX-8-04	6	-04	6.4	1/4	8	57	30	25.0
11DYX-10-05	8	-05	7.9	5/16	10	59	31	25.0
11DYX-10-06	10	-06	9.5	3/8	10	77	32	25.0
11DYX-12-06	10	-06	9.5	3/8	12	79	32	25.0
11DYX-15-08	12	-08	12.7	1/2	15	65	34	25.0
11DYX-18-10	16	-10	15.9	5/8	18	66	35	16.0
11DYX-22-12	20	-12	19.0	3/4	22	72	37	16.0
11DYX-28-16	25	-16	25.4	1	28	74	39	10.0

192YX – BSP female swivel 60° cone

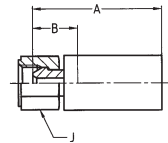

MATERIAL Galvanised steel with transparent Cr(IV)-free plating.
Other materials available on request.

Part No. #	DN size				Connection type Thread size	A mm	B mm	J mm	Max. WP MPa
	mm	inch	mm	inch					
192YX-4-03	5	-03	4.8	3/16	G 1/4	42	16	17	63.0
192YX-4-04	6	-04	6.3	1/4	G 1/4	44	17	17	63.0
192YX-6-05	8	-05	7.9	3/16	G 3/8	45	17	19	55.0
192YX-6-06	10	-06	9.5	3/8	G 3/8	46	19	22	55.0
192YX-8-06	10	-06	9.5	3/8	G 1/2	46	19	27	43.0
192YX-8-08	12	-08	12.7	1/2	G 1/2	52	21	27	43.0
192YX-12-10	16	-10	15.9	5/8	G 3/4	50	19	32	35.0
192YX-12-12	20	-12	19.0	3/4	G 3/4	56	21	32	35.0
192YX-16-12	20	-12	19.0	3/4	G 1	56	22	41	28.0
192YX-16-16	25	-16	25.4	1	G 1	57	22	41	28.0
192YX-20-16	25	-16	25.4	1	G 1 1/4	58	24	50	25.0

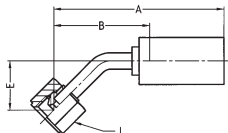
**1B1YX – BSP female swivel 60° cone
45° elbow**

MATERIAL Galvanised steel with transparent Cr(IV)-free plating.
Other materials available on request.

Part No. #	DN size mm inch				Connection type	A mm	B mm	E mm	J mm	Max. WP MPa
	size	mm	inch	Thread size						
1B1YX-4-03	5	-03	4.8	3/16	G 1/4	58	32	17	17	63.0
1B1YX-4-04	6	-04	6.4	1/4	G 1/4	69	41	21	17	63.0
1B1YX-6-05	8	-05	7.9	5/16	G 3/8	68	39	17	22	55.0
1B1YX-6-06	10	-06	9.5	3/8	G 3/8	64	36	14	22	55.0
1B1YX-8-06	10	-06	9.5	3/8	G 1/2	65	37	15	27	43.0
1B1YX-8-08	12	-08	12.7	1/2	G 1/2	86	54	18	27	43.0
1B1YX-12-10	16	-10	15.9	5/8	G 3/4	99	68	26	32	35.0
1B1YX-12-12	20	-12	19.0	3/4	G 3/4	117	82	30	32	35.0
1B1YX-16-16	25	-16	25.4	1	G 1	120	85	43	41	28.0
1B1YX-20-16	25	-16	25.4	1	G 1 1/4	116	81	34	50	25.0

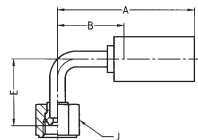
**1B2YX – BSP female swivel 60° cone
90° elbow**

MATERIAL Galvanised steel with transparent Cr(IV)-free plating.
Other materials available on request.



Part No. #	DN size mm inch				Connection type	A mm	B mm	E mm	J mm	Max. WP MPa
	size	mm	inch	Thread size						
1B2YX-4-03	5	-03	4.8	3/16	G 1/4	48	22	24	17	63.0
1B2YX-4-04	6	-04	6.4	1/4	G 1/4	58	30	30	17	63.0
1B2YX-6-05	8	-05	7.9	5/16	G 3/8	59	30	28	22	55.0
1B2YX-6-06	10	-06	9.5	3/8	G 3/8	58	30	30	22	55.0
1B2YX-8-06	10	-06	9.5	3/8	G 1/2	58	30	31	27	43.0
1B2YX-8-08	12	-08	12.7	1/2	G 1/2	74	42	38	27	43.0
1B2YX-12-10	16	-10	15.9	5/8	G 3/4	84	53	50	32	35.0
1B2YX-12-12	20	-12	19.0	3/4	G 3/4	100	65	60	32	35.0
1B2YX-16-16	25	-16	25.4	1	G 1	100	65	69	41	28.0
1B2YX-20-16	25	-16	25.4	1	G 1 1/4	100	65	70	50	25.0

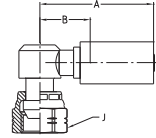

1B4YX – BSP female swivel 60° cone 90° compact elbow





MATERIAL Galvanised steel with transparent Cr(IV)-free plating.
Other materials available on request.

Part No. #	DN size mm inch				Connection type Thread size 	A mm	B mm	J mm	Max. WP MPa
									
1B4YX-4-04	6	-04	6.3	1/4	G 1/4	46	19	19	63.0
1B4YX-6-05	8	-05	7.9	3/16	G 3/8	51	23	22	55.0
1B4YX-6-06	10	-06	9.5	3/8	G 3/8	51	24	22	55.0
1B4YX-8-08	12	-08	12.7	1/2	G 1/2	57	26	27	43.0

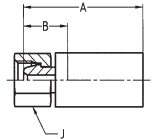
1U0YX – BSP female swivel (ballnose) BSP swivel nut



MATERIAL Galvanised steel with transparent Cr(IV)-free plating.
For fittings as mentioned above, but with stainless steel nipple
(AISI 303), please add **C2W** to the Part No. Example: 1U0YX-4-03 **C2W**.
Other materials available on request.

Part No. #	DN size mm inch				Connection type Thread size 	A mm	B mm	J mm	Max. WP MPa
									
1U0YX-2-03	5	-03	4.8	3/16	G 1/8	43	18	17	41.0
1U0YX-4-03	5	-03	4.8	3/16	G 1/4	42	16	17	63.0
1U0YX-4-04	6	-04	6.4	1/4	G 1/4	45	17	17	63.0
1U0YX-6-03	5	-03	4.8	3/16	G 3/8	45	17	17	55.0
1U0YX-6-04	6	-04	6.4	1/4	G 3/8	45	17	17	55.0
1U0YX-6-05	8	-05	7.9	5/16	G 3/8	45	17	19	55.0
1U0YX-6-06	10	-06	9.5	3/8	G 3/8	48	19	22	55.0
1U0YX-8-06	10	-06	9.5	3/8	G 1/2	48	19	27	43.0
1U0YX-8-08	12	-08	12.7	1/2	G 1/2	53	21	27	43.0
1U0YX-10-08	12	-08	12.7	1/2	G 5/8	51	20	27	35.0
1U0YX-12-10	16	-10	15.9	5/8	G 3/4	50	19	32	35.0
1U0YX-12-12	20	-12	19.0	3/4	G 3/4	56	21	32	35.0
1U0YX-16-12	20	-12	19.0	3/4	G 1	56	22	41	28.0
1U0YX-16-16	25	-16	25.4	1	G 1	57	22	41	28.0
1U0YX-20-16	25	-16	25.4	1	G 1 1/4	58	24	50	21.0

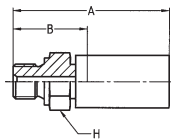
1D9YX – BSP male
DIN 3852 Form A

MATERIAL Galvanised steel with transparent Cr(IV)-free plating.
Other materials available on request.

Part No. #	DN size mm inch				Connection type	A mm	B mm	H mm	Max. WP MPa
					Thread size 				
1D9YX-2-03	5	-03	4.8	3/16	G 1/8	48	22	14	55.0
1D9YX-4-03	5	-03	4.8	3/16	G 1/4	54	29	19	63.0
1D9YX-4-04	6	-04	6.4	1/4	G 1/4	58	29	19	63.0
1D9YX-6-05	8	-05	7.9	5/16	G 3/8	58	29	22	55.0
1D9YX-4-06	10	-06	9.5	3/8	G 1/4	57	30	19	63.0
1D9YX-6-06	10	-06	9.5	3/8	G 3/8	58	30	22	55.0
1D9YX-8-06	10	-06	9.5	3/8	G 1/2	60	33	27	43.0
1D9YX-8-08	12	-08	12.7	1/2	G 1/2	64	33	27	43.0
1D9YX-12-10	16	-10	15.9	5/8	G 3/4	66	35	32	35.0
1D9YX-12-12	20	-12	19.0	3/4	G 3/4	72	37	32	35.0
1D9YX-16-12	20	-12	19.0	3/4	G 1	74	39	41	28.0
1D9YX-20-16	25	-16	25.4	1	G 1 1/4	76	41	50	21.0

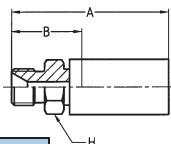
13BYX – BSP male 60° flare

MATERIAL Galvanised steel with transparent Cr(IV)-free plating.
Other materials available on request.

Part No. #	DN size mm inch				Connection type	A mm	B mm	H mm	Max. WP MPa
					Thread size 				
13BYX-2-03	5	-03	4.8	3/16	G 1/8	48	22	14	55.0
13BYX-4-03	5	-03	4.8	3/16	G 1/4	51	26	17	63.0
13BYX-4-04	6	-04	6.4	1/4	G 1/4	53	26	17	63.0
13BYX-6-05	8	-05	7.9	5/16	G 3/8	57	28	22	55.0
13BYX-6-06	10	-06	9.5	3/8	G 3/8	57	29	22	63.0
13BYX-8-06	10	-06	9.5	3/8	G 1/2	62	34	24	55.0
13BYX-8-08	12	-08	12.7	1/2	G 1/2	66	34	24	43.0
13BYX-12-10	16	-10	15.9	5/8	G 3/4	69	38	32	43.0
13BYX-12-12	20	-12	19.0	3/4	G 3/4	73	38	32	35.0
13BYX-16-12	20	-12	19.0	3/4	G 1	82	47	36	35.0
13BYX-16-16	25	-16	25.4	1	G 1	82	47	36	28.0
13BYX-20-16	25	-16	25.4	1	G 1 1/4	84	49	50	21.0



101YX – National Pipe Tapered (NPT) male

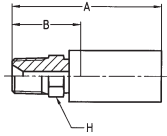

MATERIAL Galvanised steel with transparent Cr(IV)-free plating.
Other materials available on request.

Part No. #	DN size				Connection type Thread size	A mm	B mm	H mm	Max. WP MPa
	mm	inch	mm	inch					
101YX-2-03	5	-03	4,8	3/16	1/8 - 27NPTF	48	23	12	34,5
101YX-4-03	5	-03	4,8	3/16	1/4 - 18NPTF	52	27	14	34,5
101YX-4-04	6	-04	6,4	1/4	1/4 - 18NPTF	54	27	14	34,5
101YX-6-04	6	-04	6,4	1/4	3/8 - 18NPTF	56	29	19	27,5
101YX-6-05	8	-05	7,9	5/16	3/8 - 18NPTF	57	29	19	27,5
101YX-4-06	10	-06	9,5	3/8	1/4 - 18NPTF	55	28	14	34,5
101YX-6-06	10	-06	9,5	3/8	3/8 - 18NPTF	57	30	19	27,5
101YX-6-08	12	-08	12,7	1/2	3/8 - 18NPTF	61	30	19	27,5
101YX-8-08	12	-08	12,7	1/2	1/2 - 14NPTF	66	35	22	24,0
101YX-12-10	16	-10	15,9	5/8	3/4 - 14NPTF	66	35	27	21,0
101YX-12-12	20	-12	19,0	3/4	3/4 - 14NPTF	70	35	27	21,0
101YX-16-12	20	-12	19,0	3/4	1 - 11 1/2NPTF	77	42	36	17,0
101YX-16-16	25	-16	25,4	1	1 - 11 1/2NPTF	78	42	36	17,0

103YX – SAE (JIC) 37° male

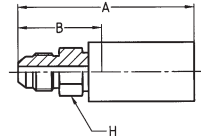

MATERIAL Galvanised steel with transparent Cr(IV)-free plating.
Other materials available on request.



Part No. #	DN size				Connection type Thread size	A mm	B mm	H mm	Max. WP MPa
	mm	inch	mm	inch					
103YX-4-03	5	-03	4,8	3/16	7/16 - 20UNF	52	27	14	41,0
103YX-5-04	6	-04	6,4	1/4	1/2 - 20UNF	56	29	14	41,0
103YX-6-05	8	-05	7,9	5/16	9/16 - 18UNF	57	29	17	34,5
103YX-8-06	10	-06	9,5	3/8	3/4 - 16UNF	60	33	22	34,5
103YX-10-08	12	-08	12,7	1/2	7/8 - 14UNF	70	38	24	34,5
103YX-12-10	16	-10	15,9	5/8	1 1/16 - 12UNF	71	40	30	34,5
103YX-16-12	20	-12	19,0	3/4	1 5/16 - 12UNF	76	41	36	27,5
103YX-20-16	25	-16	25,4	1	1 5/8 - 12UNF	78	43	46	20,0

YX series

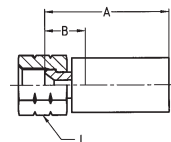
106YX – SAE (JIC) 37° female swivel UNF swivel nut





MATERIAL Galvanised steel with transparent Cr(IV)-free plating.
Other materials available on request.

Part No. #	DN size mm inch				Connection type	A mm	B mm	J mm	Max. WP MPa
					Thread size 				
106YX-4-03	5	-03	4.8	3/16	7/16 - 20UNF	40	15	17	41.0
106YX-5-04	6	-04	6.4	1/4	1/2 - 20UNF	42	15	19	41.0
106YX-6-05	8	-05	7.9	5/16	9/16 - 18UNF	45	17	19	34.5
106YX-8-06	10	-06	9.5	3/8	3/4 - 16UNF	46	19	24	34.5
106YX-10-08	12	-08	12.7	1/2	7/8 - 14UNF	49	18	27	34.5
106YX-12-10	16	-10	15.9	5/8	1 1/16 - 12UNF	50	19	32	34.5
106YX-16-12	20	-12	19.0	3/4	1 5/16 - 12UNF	56	22	41	27.5
106YX-20-16	25	-16	25.4	1	1 5/8 - 12UNF	56	22	50	20.0

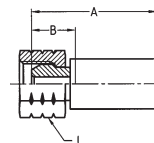
107YX – NPSM female swivel



MATERIAL Galvanised steel with transparent Cr(IV)-free plating.
For fittings as mentioned above, but with stainless steel nipple
(AISI 303), please add **C2W** to the Part No. Example: 107YX-4-04 **C2W**.
Other materials available on request.

Part No. #	DN size mm inch				Connection type	A mm	B mm	J mm	Max. WP MPa
					Thread size 				
107YX-4-03	5	-03	4.8	3/16	1/4 - 18NPSM	44	19	17	34.5
107YX-2-03	5	-03	4.8	3/16	1/8 - 27NPSM	47	21	17	34.5
107YX-4-04	6	-04	6.4	1/4	1/4 - 18NPSM	47	19	19	34.5
107YX-6-05	8	-05	7.9	5/16	3/8 - 18NPSM	48	20	22	27.5
107YX-6-06	10	-06	9.5	3/8	3/8 - 18NPSM	50	21	22	27.5
107YX-8-08	12	-08	12.7	1/2	1/2 - 14NPSM	51	19	27	24.0
107YX-12-10	16	-10	15.9	5/8	3/4 - 14NPSM	53	22	32	21.0
107YX-12-12	20	-12	19.0	3/4	3/4 - 14NPSM	59	24	32	21.0



137YX – SAE (JIC) 37° female swivel 45° elbow – UNF swivel nut

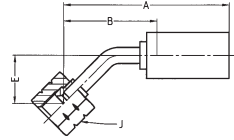

MATERIAL Galvanised steel with transparent Cr(IV)-free plating.
Other materials available on request.

Part No. #	DN size				Connection type Thread size	A mm	B mm	E mm	J mm	Max. WP MPa
	mm	inch	mm	inch						
137YX-4-03	5	-03	4.8	3/16	7/16 - 20UNF	57	31	16	17	41.0
137YX-5-04	6	-04	6.4	1/4	1/2 - 20UNF	69	41	21	19	41.0
137YX-6-05	8	-05	7.9	5/16	9/16 - 18UNF	67	38	16	19	34.5
137YX-8-06	10	-06	9.5	3/8	3/4 - 16UNF	65	37	15	24	34.5
137YX-10-08	12	-08	12.7	1/2	7/8 - 14UNF	81	49	19	27	34.5
137YX-12-10	16	-10	15.9	5/8	1 1/16 - 12UNF	96	65	27	32	34.5
137YX-16-12	20	-12	19.0	3/4	1 5/16 - 12UNF	114	79	32	41	27.5
137YX-20-16	25	-16	25.4	1	1 5/8 - 12UNF	113	78	36	50	20.0

139YX – SAE (JIC) 37° female swivel 90° elbow – UNF swivel nut

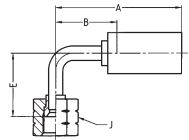

MATERIAL Galvanised steel with transparent Cr(IV)-free plating.
Other materials available on request.

Part No. #	DN size				Connection type Thread size	A mm	B mm	E mm	J mm	Max. WP MPa
	mm	inch	mm	inch						
139YX-4-03	5	-03	4.8	3/16	7/16 - 20UNF	48	22	24	17	41.0
139YX-5-04	6	-04	6.4	1/4	1/2 - 20UNF	58	30	31	19	41.0
139YX-6-05	8	-05	7.9	5/16	9/16 - 18UNF	59	30	28	19	34.5
139YX-8-06	10	-06	9.5	3/8	3/4 - 16UNF	58	30	31	24	34.5
139YX-10-08	12	-08	12.7	1/2	7/8 - 14UNF	74	42	39	27	34.5
139YX-12-10	16	-10	15.9	5/8	1 1/16 - 12UNF	84	53	52	32	34.5
139YX-16-12	20	-12	19.0	3/4	1 5/16 - 12UNF	100	65	62	41	27.5
139YX-20-16	25	-16	25.4	1	1 5/8 - 12UNF	100	65	73	50	20.0

YX series

Chapter D

Hose and fittings for alternative fuels

CNG hose

5CNG – Compressed natural gas dispense hose D-2

Fittings for CNG hose

55 series E-53
 58 series E-81
 JJ series D-3

LPG hose

8LPG – Hose for mobile applications in vehicles D-4

Fittings for LPG hose

PX-LPG series D-5

5CNG – Compressed natural gas dispense hose

According to NFPA 52, AGA 1-93 and AGA/CGA,

ANSI Standards 4.2/12.52,

Approved according to CSA ECE R110

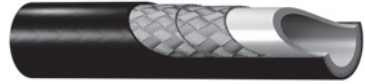

MAIN FEATURES

- High flexibility, compact construction
- Strong polyurethane cover for high wear and tear resistance
- Working pressure 34.5 MPa
- Also available as twinline or multiline hose
- Customized preforming available (see Bulletin 5200-Preformed)
- Electrically conductive

APPLICATIONS

- Dispense hose for natural gas and other gases
- Fixed applications such as refuelling hoses for natural gas fuelling stations, compressors, chemical plants or gas processing installations
- Mobile applications in vehicles

CONSTRUCTION

- Core tube** : Electrically conductive polymer
- Pressure reinforcement** : Two or more braided layers of high tensile synthetic fibre
- Cover** : Polyurethane, pinpricked
- Colour** : Red, other colours available on request

TEMPERATURE RANGE

-40°C up to +82°C

Part No. #	DN size				mm	Max. working pressure		Min. burst pressure		Min. bend radius	Weight	Fittings
	mm	inch	mm	inch		MPa / psi	MPa / psi	mm	kg/m			
5CNG-3*	5	-03	4.8	3/16	10.9	34.5	5,000	138.0	20,000	38	0.07	55
5CNG-4	6	-04	6.4	1/4	12.6	34.5	5,000	138.0	20,000	51	0.16	58
5CNG-6	10	-06	9.9	3/8	16.3	34.5	5,000	138.0	20,000	76	0.14	55
5CNG-8	12	-08	12.7	1/2	22.7	34.5	5,000	138.0	20,000	102	0.31	58
5CNG-12	20	-12	19.3	3/4	29.2	34.5	5,000	138.0	20,000	191	0.36	58H
5CNG-16	25	-16	26.0	1	40.4	34.5	5,000	138.0	20,000	254	0.53	58H

*: Only available on request

- Fittings 55 series see E-53 ff.; 58 series see E-81 ff.; Fittings 58H series available on request

• Ready-to-use refuelling hose assemblies:

5CNG-4-3000, both ends JIC 7/16 x 20 UNF, length 3 m

5CNG-6-3000, both ends JIC 9/16 x 18 UNF, length 3 m

5CNG-8-3000, both ends JIC 7/8 x 14 UNF, length 3 m

NOTES

- Not for use in paint spray applications
- For refuelling systems additionally hose guards and warning tag must be ordered
- Twinline constructions for return lines available
- Hose assemblies with CSA approval can be delivered ex factory or via CSA certified Parker partners
- For mobile applications 5CNG-3 or 5CNG-8 with JJ series fittings (SAE (JIC) 45° female swivel) acc. to ECE R 110 are to be used (see page D-3).

108JJ – SAE (JIC) 45° female swivel

UNF swivel nut

Approved according to ECE R 110

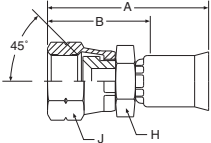

MATERIAL Stainless steel.
Other materials available on request.

Part No. #	DN size				Connection type		A mm	B mm	H mm	J mm	Max. WP MPa
	mm	inch	Thread size	Tube OD inch							
108JJ-8-8C	12	-08	12.7	1/2	3/4 - 16UNF	1/2	88	38	22	22	26.0

Other fittings available on request.

8LPG – Hose for mobile applications in vehicles

Certified acc. to ECE R 67 class 1

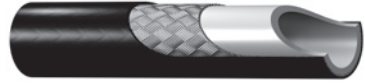
**MAIN FEATURES**

- Compact construction, high flexibility
- Working pressure 3.0 MPa
- Highly resistant polymer core tube
- Strong polymer cover for high wear and tear resistance, weatherproof, UV- and ozone-resistant
- Customized preforming available (see Bulletin 5200-Preformed)

APPLICATIONS

LPG-system for cars, trucks and busses

CONSTRUCTION**Core tube** : Polyamide**Pressure reinforcement** : One layer of high tensile synthetic fibre**Cover**

: Polyamide, pinpricked; opt. flame resist. cover Type -FR(*)

Colour

: Black, other colours available on request

TEMPERATURE RANGE

-25°C up to +100°C (short time 125°C)

Part No. #	DN size		mm		mm	Max. working pressure MPa / psi		Min. burst pressure MPa / psi		Min. bend radius mm	Weight kg/m	Fittings
	mm	inch	mm	inch		MPa	psi	MPa	psi			
8LPG-3	5	-03	4.8	3/16	8.0	3.0	435	15.0	2,175	50	0.033	PX-LPG
8LPG-4	6	-04	6.3	1/4	9.8	3.0	435	15.0	2,175	75	0.043	PX-LPG
8LPG-5	8	-05	7.9	5/16	12.2	3.0	435	15.0	2,175	90	0.067	PX-LPG
8LPG-6	10	-06	9.5	3/8	13.7	3.0	435	15.0	2,175	100	0.075	PX-LPG
8LPG-3-FR*	5	-03	4.8	3/16	9.5	3.0	435	15.0	2,175	50	0.058	PX-LPG
8LPG-4-FR*	6	-04	6.3	1/4	11.5	3.0	435	15.0	2,175	75	0.071	PX-LPG

*Improved mechanical and chemical protection through flame resistant 2nd outer cover acc. to AS/NZS 1869**NOTES**

- The hose assemblies are produced acc. to ECE R67 regulations and can be delivered ex factory or via certified Parker partners.
- For required equipment containing crimping machine for small and serial production and for certification procedure please ask your responsible Parker office.

LPG fittings certified acc. to ECE R 67

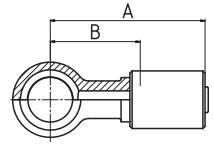
149PX – Banjo union
DIN 7642

MATERIAL Galvanised steel with transparent Cr(IV)-free plating.
Other materials available on request.

Part No. #	DN size mm inch				Connection type		A mm	B mm	Max. WP MPa
	Thread size	Tube OD mm							
149PX-10-03-LPG	5	-03	4.8	3/16	10x1.5	10	35.0	20.7	3.0
149PX-10-04-LPG	6	-04	6.3	1/4	10x1.5	10	35.0	20.7	3.0
149PX-10-05-LPG	8	-05	7.9	5/16	10x1.5	10	41.0	22.3	3.0

Metric banjo bolt M10x1 DIN 7643 and 2 gasket rings (copper) included.
Wrench size for banjo bolt: 14 mm.

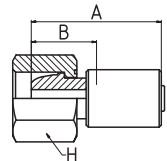
1C3PX – Metric female swivel 24°/60°
Light series – Metric swivel nut

MATERIAL Galvanised steel with transparent Cr(IV)-free plating.
Other materials available on request.

Part No. #	DN size mm inch				Connection type		A mm	B mm	H mm	Max. WP MPa
	Thread size	Tube OD mm								
1C3PX-8-03-LPG	5	-03	4.8	3/16	M14x1.5	8	30.0	15.0	17	3.0
1C3PX-8-04-LPG	6	-04	6.3	1/4	M14x1.5	8	30.0	15.0	17	3.0
1C3PX-8-05-LPG	8	-05	7.9	5/16	M14x1.5	8	35.4	16.7	17	3.0

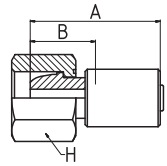
1U0PX – BSP female swivel (ballnose)**BSP swivel nut**

MATERIAL Galvanised steel with transparent Cr(IV)-free plating.
Other materials available on request.

Part No. #	DN size				Connection type		A mm	B mm	H mm	Max. WP MPa
	mm	inch	Thread size	Tube OD inch						
1U0PX-4-03-LPG	5	-03	4.8	3/16	G1/4	1/4	30.0	15.0	17	3.0
1U0PX-4-04-LPG	6	-04	6.3	1/4	G1/4	1/4	30.0	15.0	17	3.0
1U0PX-4-05-LPG	8	-05	7.9	5/16	G1/4	1/4	35.4	16.7	17	3.0

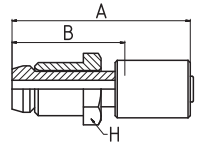
17APX – LPG 30° male swivel

MATERIAL Galvanised steel with transparent Cr(IV)-free plating.
Other materials available on request.

Part No. #	DN size				Connection type		A mm	B mm	H mm	Max. WP MPa
	mm	inch	Thread size	Tube OD mm/inch						
17APX-6-03-LPG	5	-03	4.8	3/16	M10x1	8	42.3	28	17	3.0
17APX-8-04-LPG	6	-04	6.3	1/4	M12x1	8	45.3	31	17	3.0
17APX-4-03S-LPG	8	-05	7.9	5/16	7/16-20 UNF	1/4"	42.3	28	17	3.0

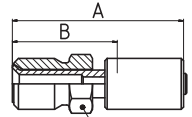
128PX – SAE (JIC) 45° male swivel
UNF male swivel

MATERIAL Galvanised steel with transparent Cr(IV)-free plating.
Other materials available on request.

Part No. #	DN size				Connection type		A mm	B mm	H mm	Max. WP MPa
	mm	inch	Thread size	Tube OD inch						
128PX-4-03-LPG	5	-03	4.8	3/16	7/16-20 UNF	1/4	37	23	14	3.0

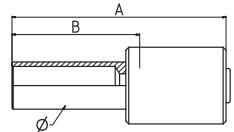
11DPX – Metric standpipe
Light series

MATERIAL Galvanised steel with transparent Cr(IV)-free plating.
Other materials available on request.

Part No. #	DN size				Connection type		A mm	B mm	Ø mm	Max. WP MPa
	mm	inch	Thread size	Tube OD mm						
11DPX-8-04-LPG	6	-04	6.3	1/4	–	8	36.3	22	8	3.0

Swivel nut G1/4" and cutting ring (brass) included.

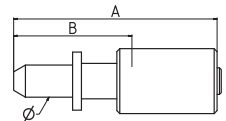
1PHPX – LPG quick connector

MATERIAL Galvanised steel with transparent Cr(IV)-free plating.
Other materials available on request.

Part No. #	DN size				Connection type		A mm	B mm	Ø mm	Max. WP MPa
	mm	inch	Thread size	Tube OD mm						
1PHPX-5.5-03S-LPG	6	-04	6.3	1/4	–	5.5	34.5	21	5.5	3.0

Other fittings available on request.

Chapter E

Hose and fittings for hydraulic and industrial applications

Part 1 – Small bore hose/mini-hydraulic hose	E-2
Part 2 – Medium pressure hose.....	E-5
Part 3 – High pressure hose.....	E-14
Part 4 – Paint spray hose	E-26
Part 5 – Gas hose.....	E-32
Part 6 – Twinline and multiline hose.....	E-42
Part 7 – Preform hose, hose coils and hose bundles.....	E-44
Part 8 – Hose fittings	E-47

Part 1 – Small bore hose/mini-hydraulic hose

- 2010N** – Small bore hose/mini-hydraulic hose up to 27.5 MPa E-3
- 2010H** – Small bore hose/mini-hydraulic hose up to 21 MPa.....E-3
- 2020N** – Small bore hose/mini-hydraulic hose up to 63 MPa.....E-4

Small bore

2010N/2010H – Small bore hose/mini-hydraulic hose

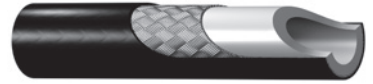

MAIN FEATURES

- Small dimensions
- Small bend radii

APPLICATIONS

- Medium pressure services, when **very small hose outer diameters** are required
- Versatile usage in mini-hydraulic and gas applications
- **Lubricating systems (2010H)**
- **Measuring / diagnosis systems**

CONSTRUCTION

Core tube : 2010N: polyamide / 2010H: polyester elastomer
Pressure reinforcement : One braided layer of high tensile synthetic fibre

Cover : 2010N: polyamide, pinpricked / 2010H: polyurethane pinpricked
Colour : black

TEMPERATURE RANGE

-40°C up to +100°C for petroleum or synthetic hydraulic fluids.

Small bore

Part No. #	DN size				mm	Max. working pressure		Min. burst pressure		Min. bend radius	Weight	Fittings
	mm	inch	mm	inch		MPa / psi	MPa / psi	MPa / psi	kg/m			
2010N-012V30	2	-12	2	5/64	4.9	27.5	3,985	110.0	15,950	20	0.016	EX

Part No. #	DN size				mm	Max. working pressure		Min. burst pressure		Min. bend radius	Weight	Fittings
	mm	inch	mm	inch		MPa / psi	MPa / psi	MPa / psi	kg/m			
2010H-025V00	4	-25	4	5/32	8.3	21.0	3,045	84.0	12,180	35	0.065	EX

NOTES -

2020N – Small bore hose/mini-hydraulic hose (high pressure)



MAIN FEATURES

- Small dimensions
- Small bend radii
- Working pressures up to 63 MPa

APPLICATIONS

- High pressure services, when **very small hose outer diameters** are required
- Versatile usage in mini-hydraulic and gas applications
- **Measuring / diagnosis systems**

CONSTRUCTION

- Core tube** : Polyamide
Pressure reinforcement : One braided layer of high tensile synthetic fibre
- Cover** : Polyamide, pinpricked
Colour : black

TEMPERATURE RANGE

-40°C up to +100°C for petroleum or synthetic hydraulic fluids.

Part No. #	DN	size	mm	inch	mm	Max. working pressure MPa / psi		Min. burst pressure MPa / psi		Min. bend radius mm	Weight kg/m	Fittings
2020N-012V30	2	-12	2	5/64	4.9	47.5	6,885	190.0	27,550	20	0.016	EX
2020N-016V30	2,5	-16	2.5	3/32	5.9	40.0	5,800	160.0	23,200	20	0.016	EX
2020N-02V30	3	-02	2.9	1/8	6.0	40.0	5,800	160.0	23,200	30	0.023	EX
2020N-025V30	4	-25	4	5/32	8.1	44.0	6,380	176.0	25,520	40	0.042	EX
2020N-012V50	2	-12	2	5/64	4.9	63.0	9,135	190.0	27,550	20	0.016	EX
2020N-025V50	4	-25	4	5/32	8.1	50.0	7,250	176.0	25,520	40	0.042	EX

NOTES

- V50: Safety factor reduced for diagnostic applications.
- 2020N-02V30 and 2020N-025V30 with DNV approval for hydraulic systems.

Part 2 – Medium pressure hose

515H	– Compact pilot line hose	E-6
550H	– Standard hydraulic hose	E-7
540N	– Medium pressure hose for aggressive fluids	E-8
560	– Medium pressure hose with steel wire reinforcement.....	E-9
510A	– Refrigerant hose.....	E-10
518C	– Medium pressure hose, electrically non-conductive	E-11
1202LT	– Low temperature hose – constant working pressure.....	E-12
55LT	– Low temperature hose	E-13

515H – Compact pilot line hose

Performance exceeds SAE 100 R3



MAIN FEATURES

- **Very small bend radii**
- High abrasion resistance
- Compact and **very small hose outer diameters**
- Working pressures up to 15 MPa

APPLICATIONS

- Medium pressure service for use with petroleum, synthetic or water-based hydraulic fluids
- When a hose with **very small outer diameter** is required
- **Pilot lines** in hydraulic systems

CONSTRUCTION

- Core tube** : Polyester elastomer
Pressure reinforcement : One braided layer of high tensile synthetic fibre
- Cover** : Polyurethane, pinpricked
Colour : black

TEMPERATURE RANGE

-40°C up to +100°C for petroleum, max. 57°C for synthetic hydraulic fluids and water-based hydraulic fluids.

Part No. #	DN size				mm	Max. working pressure		Min. burst pressure		Min. bend radius	Weight	Fittings
	mm	inch	MPa	psi		MPa	psi	mm	kg/m			
515H-3	5	-03	4.8	3/16	8.3	15.0	2,175	60.0	8,700	19	0.04	54
515H-4	6	-04	6.3	1/4	10.3	14.0	2,000	56.0	8,000	38	0.07	54
515H-5	8	-05	7.9	5/16	12.2	12.0	1,750	48.0	7,000	43	0.08	54
515H-6	10	-06	9.5	3/8	14.0	10.0	1,500	40.0	6,000	51	0.09	54
515H-8	12	-08	12.7	1/2	18.0	10.0	1,500	40.0	6,000	76	0.17	54

NOTES -

Medium pressure

550H – Standard hydraulic hose

Performance exceeds SAE 100 R7 /
ISO 3949 Type R7 / DIN EN 855 Type R7

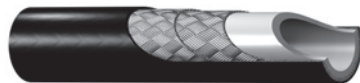

MAIN FEATURES

- High abrasion resistance
- Small bend radii
- Low weight
- High flexibility

APPLICATIONS

- Medium pressure service for general industrial and mobile hydraulic applications such as
- Construction and agricultural machinery
 - Material conveying systems/lifting devices
 - Machine tools

CONSTRUCTION

Core tube : Polyester elastomer
Pressure reinforcement : One or two braided layers of high tensile synthetic fibre

Cover : Polyurethane, pinpricked
Colour : black

TEMPERATURE RANGE

-40°C up to +100°C for petroleum, max. 57°C for synthetic hydraulic fluids and water-based hydraulic fluids.

Part No. #	DN	size	mm		mm	Max. working pressure MPa / psi		Min. burst pressure MPa / psi		Min. bend radius mm	Weight kg/m	Fittings
			mm	inch		MPa	psi	MPa	psi			
550H-3	5	-03	4.8	3/16	10.7	22.5	3,250	90.0	13,000	19	0.08	55/56
550H-4	6	-04	6.3	1/4	12.6	21.0	3,000	83.0	12,000	32	0.10	55/56
550H-5	8	-05	7.9	5/16	14.3	17.5	2,500	69.0	10,000	44	0.13	55/56
550H-6	10	-06	9.5	3/8	16.3	15.5	2,250	62.0	9,000	51	0.14	55/56
550H-8	12	-08	12.7	1/2	20.3	14.0	2,000	56.0	8,000	76	0.21	55/56
550H-10	16	-10	15.9	5/8	24.5	10.0	1,500	40.0	6,000	102	0.30	58/56
550H-12	20	-12	19.1	3/4	27.4	8.5	1,250	34.5	5,000	127	0.31	55/56
550H-16	25	-16	25.4	1	33.3	7.0	1,000	27.5	4,000	203	0.40	55/56

NOTES

Also available as twinline or multilined hose, see page E-43.

540N – Medium pressure hose

Performance exceeds SAE 100 R7 /
ISO 3949 Type R7 / DIN EN 855 Type R7

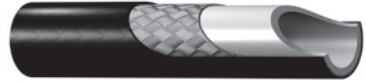

MAIN FEATURES

- High abrasion resistance
- Small bend radii
- Low weight
- **Excellent chemical resistance due to polyamide core tube**

APPLICATIONS

Medium pressure service for general industrial and mobile hydraulic applications, especially when an improved chemical resistance is required with some hydraulic/chemical fluids.

CONSTRUCTION

Core tube : Polyamide
Pressure reinforcement : One braided layer of high tensile synthetic fibre

Cover : Polyurethane, pinpricked
Colour : black

TEMPERATURE RANGE

-40°C up to +100°C

Part No. #	DN size				mm	Max. working pressure		Min. burst pressure		Min. bend radius	Weight	Fittings
	mm	inch	MPa	psi		MPa	psi	mm	kg/m			
540N-2	3	-02	3.2	1/8	8.4	17.5	2,500	69.0	10,000	13	0.05	57
540N-3	5	-03	4.8	3/16	10.7	21.0	3,000	83.0	12,000	19	0.08	55/56
540N-4	6	-04	6.3	1/4	12.6	19.0	2,750	76.0	11,000	38	0.10	55/56
540N-5	8	-05	7.9	5/16	14.6	17.5	2,500	69.0	10,000	44	0.12	55/56
540N-6	10	-06	9.5	3/8	16.4	15.5	2,250	62.0	9,000	51	0.14	55/56
540N-8	12	-08	12.7	1/2	20.1	14.0	2,000	56.0	8,000	76	0.21	55/56
540N-12	20	-12	19.1	3/4	26.5	8.5	1,250	34.5	5,000	152	0.25	55/56

NOTES

Also available as twinline or multiline hose, see page E-43.

560 – Medium pressure hose

Performance exceeds SAE 100 R1 /
DIN EN 853-1SN



MAIN FEATURES

- High abrasion resistance
- Small bend radii
- **Steel wire pressure reinforcement**

APPLICATIONS

Medium pressure service for general industrial and mobile hydraulic applications.

CONSTRUCTION

Core tube : Polyester elastomer
Pressure reinforcement : One braided layer of high tensile steel wire

Cover : Polyurethane
Colour : black

TEMPERATURE RANGE

-40°C up to +121°C for petroleum, max. 57°C for synthetic hydraulic fluids and water-based hydraulic fluids.

Part No. #	DN	size		mm	inch	mm	Max. working pressure		Min. burst pressure		Min. bend radius	Weight	Fittings
		mm	inch				MPa	psi	MPa	psi			
560-3	5	-03	4.8	3/16	10.7	24.0	3,500	96.0	14,000	19	0.11	55/56	
560-4	6	-04	6.3	1/4	13.0	22.5	3,250	90.0	13,000	44	0.15	55/56	
560-5	8	-05	7.9	5/16	14.4	21.0	3,000	83.0	12,000	50	0.19	55/56	
560-6	10	-06	9.5	3/8	16.3	19.0	2,750	76.0	11,000	57	0.22	55/56	
560-8	12	-08	12.7	1/2	20.1	17.5	2,500	62.0	9,000	83	0.30	55/56	
560-10	16	-10	15.9	5/8	23.4	14.0	2,000	56.0	8,000	151	0.46	55/56	
560-12	20	-12	19.1	3/4	28.4	12.0	1,750	48.0	7,000	178	0.60	58/56	

NOTES

Also available as twinline or multiline hose, see page E-43.

510A – Refrigerant hose

Performance exceeds SAE 100 R7 /
ISO 3949 Type R7 / DIN EN 855 Type R7



MAIN FEATURES

- Suited for many common refrigerants
- High abrasion resistance
- Small bend radii
- Low weight

APPLICATIONS

For applications in coolant technology for fluids such as Freon®/R12/R22/R134A. Other refrigerants on request.

CONSTRUCTION

Core tube : Polyamide copolymer
Pressure reinforcement : Two braided layers of high tensile synthetic fibre
Cover : Polyurethane, pinpricked
Colour : black

TEMPERATURE RANGE

-40°C up to +100°C

Part No. #	DN size				mm	Max. working pressure		Min. burst pressure		Min. bend radius	Weight	Arma- turen
	mm	inch	MPa	psi		MPa	psi	mm	kg/m			
510A-3	5	-03	4.8	3/16	10.7	21.0	3,000	83.0	12,000	51	0.07	55/56
510A-4	6	-04	6.3	1/4	11.7	19.0	2,750	76.0	11,000	64	0.08	55/56
510A-6	10	-06	9.5	3/8	16.0	15.5	2,250	62.0	9,000	102	0.12	55/56
510A-8	12	-08	12.7	1/2	20.3	14.0	2,000	56.0	8,000	140	0.19	55/56

NOTES

- Reusable fittings available on request.
- Freon® is a registered trademark of E. I. DuPont de Nemours Co. Inc.

518C – Medium pressure hose

Electrically non-conductive –

Performance exceeds SAE 100 R7 /

ISO 3949 Type R7 / DIN EN 855 Type R7



MAIN FEATURES

- Electrically non-conductive
- High abrasion resistance
- Small bend radii
- Low weight

APPLICATIONS

Medium pressure service for general industrial and mobile hydraulic applications, when **electrically non-conductive** lines are required, e.g.:

- Working platforms for high-voltage line repair
- Aluminium melting furnaces

CONSTRUCTION

Core tube : Polyester elastomer, except -2: polyamide
Pressure reinforcement : One braided layer of high tensile synthetic fibre

Cover : Polyurethane
Colour : orange

TEMPERATURE RANGE

-40°C up to +100°C for petroleum, max. 57°C for synthetic hydraulic fluids and water-based hydraulic fluids.

Part No. #	DN size				mm	Max. working pressure		Min. burst pressure		Min. bend radius	Weight	Arma- turen
	mm	inch	mm	MPa / psi		MPa / psi	mm	kg/m				
518C-2	3	-02	3.2	1/8	8.4	17.5	2,500	69.0	10,000	13	0.05	57
518C-3	5	-03	4.8	3/16	10.7	22.5	3,250	90.0	13,000	19	0.07	55/56
518C-4	6	-04	6.3	1/4	11.7	20.7	3,000	83.0	12,000	38	0.08	55/56
518C-5	8	-05	7.9	5/16	14.3	17.5	2,500	69.0	10,000	44	0.11	55/56
518C-6	10	-06	9.5	3/8	16.0	15.5	2,250	62.0	9,000	51	0.14	55/56
518C-8	12	-08	12.7	1/2	20.4	15.5	2,250	62.0	9,000	76	0.22	55/56
518C-10	16	-10	15.9	5/8	24.9	10.5	1,500	42.0	6,000	102	0.30	58
518C-12	20	-12	19.1	3/4	27.4	8.5	1,250	34.5	5,000	152	0.31	55/56
518C-16	25	-16	25.4	1	33.5	7.0	1,000	27.5	4,000	203	0.40	55/56

NOTES

- Reusable fittings available on request.
- Electrically non-conductive acc. to SAE J517 (less than 50 µA leakage under 250,000 Volts per metre).

1202LT – Low temperature hose

Same working pressure for all sizes

Performance exceeds SAE 100 R18 / ISO 3949 Type R18



MAIN FEATURES

- Working pressure 21 MPa for all sizes
- Perfect solution for low temperature applications with dynamic movements
- High abrasion resistance
- Small bend radii
- Very low weight

APPLICATIONS

- Medium pressure service for general industrial and mobile hydraulic applications, especially for systems **working at very low temperatures**, e.g.:
- Fork lifts in cold storage houses,
 - Construction and agricultural machinery operating in climatic regions with lower temperatures.

CONSTRUCTION

- Core tube** : Polyester elastomer
Pressure reinforcement : One or two braided layers of high tensile synthetic fibre
- Cover** : Special polyester, pinpricked
Colour : black

TEMPERATURE RANGE

-57°C up to +100°C for petroleum, max. 57°C for synthetic hydraulic fluids and water-based hydraulic fluids.

Part No. #	DN size				mm	Max. working pressure		Min. burst pressure		Min. bend radius	Weight	Fittings
	mm	inch	mm	inch		MPa / psi	MPa / psi	mm	kg/m			
1202LT-3	5	-03	4.8	3/16	10.7	21.0	3,000	83.0	12,000	19	0.08	55/56
1202LT-4	6	-04	6.4	1/4	12.6	21.0	3,000	83.0	12,000	32	0.11	55/56
1202LT-5	8	-05	8	5/16	14.4	21.0	3,000	83.0	12,000	45	0.13	55/56
1202LT-6	10	-06	10	3/8	16.4	21.0	3,000	83.0	12,000	51	0.16	55/56
1202LT-8	12	-08	12.8	1/2	22.2	21.0	3,000	83.0	12,000	89	0.30	58/56

NOTES

Also available as twinline or multiline hose, see page E-43.

Medium pressure

55LT – Low temperature hose

Performance exceeds SAE 100 R7 /
ISO 3949 Type R7 / DIN EN 855 Type R7

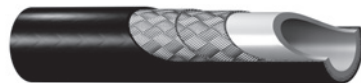

MAIN FEATURES

- Ideal for low temperature applications
- High abrasion resistance
- Small bend radii
- Low weight

APPLICATIONS

- Medium pressure service for general industrial and mobile hydraulic applications, especially for systems **working at very low temperatures**, e.g.:
- Fork lifts in cold storage houses,
 - Construction and agricultural machinery operating in climatic regions with lower temperatures.

CONSTRUCTION

Core tube : Polyester elastomer, except -02: polyamide
Pressure reinforcement : Two braided layers of high tensile synthetic fibre

Cover : Special polyester, pinpricked
Colour : black

TEMPERATURE RANGE

-57°C up to +100°C for petroleum, max. 57°C for synthetic hydraulic fluids and water-based hydraulic fluids.

Part No. #	DN	size	mm	inch	mm	Max. working pressure MPa / psi		Min. burst pressure MPa / psi		Min. bend radius mm	Weight kg/m	Fittings
55LT-2	3	-02	3.2	1/8	8.6	21.0	3,000	79.0	11,500	13	0.05	57
55LT-3	5	-03	4.8	3/16	10.9	22.5	3,250	90.0	13,000	19	0.08	55/56
55LT-4	6	-04	6.3	1/4	13.0	21.0	3,000	83.0	12,000	32	0.10	55/56
55LT-5	8	-05	7.9	5/16	14.3	17.5	2,500	69.0	10,000	44	0.13	55/56
55LT-6	10	-06	9.5	3/8	16.3	15.5	2,250	62.0	9,000	51	0.14	55/56
55LT-8	12	-08	12.7	1/2	20.3	14.0	2,000	56.0	8,000	76	0.21	55/56
55LT-12	20	-12	19.1	3/4	27.4	8.5	1,250	34.5	5,000	127	0.31	55/56

NOTES

Also available as twinline or multilines hose, see page E-43.

Part 3 – High pressure hose

PTA	– High pressure hose for reusable fittings	E-15
2040N	– Multi purpose hose	E-16
2040H	– Standard hydraulic hose	E-17
520N	– Standard hydraulic hose	E-18
528N	– Electrically non-conductive hose	E-19
580N	– Standard hydraulic hose	E-20
588N	– Electrically non-conductive hose	E-21
590	– Hybrid high pressure hose	E-22
575X	– High pressure hose, low volumetric expansion	E-23
2370N/2370H	– Multi purpose hose	E-24
2245N/2244N	– High pressure hose	E-25

PTA – High pressure hose for reusable fittings

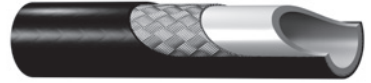

MAIN FEATURES

- Excellent abrasion resistance
- Small bend radii
- Low weight
- Excellent chemical resistance due to polyamide core tube
- **Reusable fittings allow easy on site mounting**

APPLICATIONS

High pressure service for general industrial and mobile hydraulic applications. Especially suitable for systems, where small outer diameters are required under difficult assembly conditions.

CONSTRUCTION

Core tube : Polyamide
Pressure reinforcement : One braided layer of high tensile synthetic fibre

Cover : Polyurethane, except -025: polyamide
Colour : black

TEMPERATURE RANGE

-40 °C up to +100 °C

Part No. #	DN size				mm	Max. working pressure*		Min. burst pressure		Min. bend radius	Weight	Fittings
	mm	inch	MPa / psi	MPa / psi		mm	kg/m					
PTA-025	4	-025	4.0	5/32	8.1	37.0	5,370	92.5	13,410	40	0.040	AF/AB
PTA-04	6	-04	6.3	1/4	11.4	25.5	3,700	64.0	9,280	63	0.075	AF/AB
PTA-05	8	-05	8.0	5/16	13.5	22.5	3,260	56.0	8,120	80	0.100	AF/AB
PTA-06	10	-06	10.0	3/8	16.7	19.0	2,760	47.5	6,880	100	0.145	AF/AB

NOTES

* Values are valid for 20°C. Reduced working pressure at higher temperatures:

	50°C (MPa/psi)	80°C (MPa/psi)
PTA-025	32.5 / 4,710	28.0 / 4,060
PTA-04	22.5 / 3,260	19.0 / 2,760
PTA-05	20.0 / 2,900	17.0 / 2,470
PTA-06	17.0 / 2,470	14.5 / 2,100

2040N – Multi purpose hose

Performance exceeds DIN EN 853-1SN,
DNV approved



MAIN FEATURES

- Excellent chemical resistance due to polyamide core tube and polyamide cover with V30
- Excellent abrasion resistance
- Small bend radii
- Steel wire pressure reinforcement

APPLICATIONS

High pressure service for general industrial and mobile hydraulic applications, especially when an **improved chemical resistance** is required with some hydraulic/chemical fluids. Usable **for a wide variety of fluids** due to the polyamide core tube. The polyamide cover resists aggressive fluids such as **refrigerants** in machine tools or when used in oil tanks.

CONSTRUCTION

Core tube : Polyamide
Pressure reinforcement : One braided layer of high tensile steel wire

Cover : V00: polyurethane / V30: polyamide
Colour : black

TEMPERATURE RANGE

-40°C up to +100°C for petroleum or synthetic hydraulic fluids.

Part No. #	DN size				mm	Max. working pressure		Min. burst pressure		Min. bend radius	Weight	Fittings
	mm	inch	mm	inch		MPa	psi	MPa	psi			
2040N-02V00	3	-2	3.2	1/8	7.0	35.0	5,075	140.0	20,300	30	0.07	PX
2040N-03V00	5	-3	4.7	3/16	9.8	34.0	4,930	136.0	19,720	30	0.11	56/PX
2040N-04V00	6	-4	6.3	1/4	11.9	31.0	4,495	124.0	17,980	40	0.16	56/PX
2040N-05V00	8	-5	8.2	5/16	14.0	25.0	3,625	100.0	14,500	50	0.21	56/PX
2040N-06V00	10	-6	9.7	3/8	15.9	24.0	3,480	96.0	13,920	60	0.24	56/PX
2040N-08V00	12	-8	12.8	1/2	19.3	18.5	2,680	74.0	10,730	75	0.29	56/PX
2040N-10V00	16	-10	16.0	5/8	23.5	14.0	2,030	56.0	8,120	110	0.39	PX
2040N-12V00	20	-12	19.4	3/4	26.7	12.5	1,810	50.0	7,250	170	0.50	PX
2040N-16V00	25	-16	25.0	1	33.5	10.0	1,450	40.0	5,800	230	0.60	PX
2040N-03V30	5	-3	4.7	3/16	9.8	37.5	4,440	150.0	21,750	30	0.11	PX
2040N-04V30	6	-4	6.3	1/4	11.9	31.0	4,495	124.0	17,980	40	0.16	PX
2040N-05V30	8	-5	8.2	5/16	14.0	25.0	3,630	100.0	14,500	50	0.21	PX
2040N-06V30	10	-6	9.7	3/8	15.9	24.0	3,480	96.0	13,920	60	0.24	PX
2040N-08V30	12	-8	12.8	1/2	19.3	19.5	2,830	78.0	11,310	75	0.29	PX

NOTES

- 2040N with DNV approval for hydraulic systems.
- For pinpricked hose please add "-P", e.g. **2040N-02V00-P**.
- In version V00 also available as twinline or multiline hose, see page E-43.

2040H – Standard hydraulic hosePerformance exceeds DIN EN 853-1SN,
DNV approved**MAIN FEATURES**

- Excellent abrasion resistance
- Small bend radii
- Steel wire pressure reinforcement
- **Excellent flexibility**

APPLICATIONS

High pressure service for general industrial and mobile hydraulic applications.

CONSTRUCTION

Core tube : Polyester elastomer
Pressure reinforcement : One braided layer of high tensile steel wire

Cover : Polyurethane
Colour : black

TEMPERATURE RANGE

-40°C up to +100°C for petroleum, max. 57°C for synthetic hydraulic fluids and water-based hydraulic fluids.

Part No. #	DN	size	mm	inch	mm	Max. working pressure MPa / psi		Min. burst pressure MPa / psi		Min. bend radius mm	Weight kg/m	Fittings
2040H-03V10	5	-3	4.7	3/16	9.8	34.0	4,930	136.0	19,720	30	0.12	56/PX
2040H-04V10	6	-4	6.3	1/4	11.9	31.0	4,495	124.0	17,980	40	0.17	56/PX
2040H-05V10	8	-5	8.2	5/16	14.0	25.0	3,625	100.0	14,500	50	0.21	56/PX
2040H-06V10	10	-6	9.7	3/8	15.9	24.0	3,480	96.0	13,920	60	0.26	56/PX
2040H-08V10	12	-8	12.8	1/2	19.3	18.5	2,680	74.0	10,730	75	0.31	56/PX
2040H-10V10	16	-10	16.0	5/8	23.5	14.0	2,030	56.0	8,120	110	0.43	PX
2040H-12V10	20	-12	19.4	3/4	26.7	12.5	1,810	50.0	7,250	170	0.53	PX
2040H-16V10	25	-16	25.0	1	33.5	10.0	1,450	40.0	5,800	230	0.72	PX

NOTES

- 2040H with DNV approval for hydraulic systems.
- Also available as twinline or multilined hose, see page E-43.

520N – Standard hydraulic hose

Performance exceeds SAE 100 R8 /
ISO 3949 Type R8 / DIN EN 855 Type R8

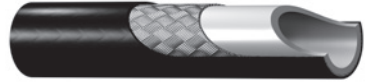

MAIN FEATURES

- **Very small hose outer diameters**
- Excellent abrasion resistance
- Small bend radii
- **Low weight**
- **Excellent chemical resistance due to polyamide core tube**

APPLICATIONS

High pressure service for general industrial and mobile hydraulic applications as well as with gases. Usable for a wide variety of fluids due to the polyamide core tube.

Version with white cover: **saltwater-proof, additionally improved UV resistance**, and therefore perfectly suited for boats and yachts.

CONSTRUCTION

Core tube : Polyamide
Pressure reinforcement : One braided layer of high tensile aramide fibre

Cover : Polyurethane, pinpricked
Colour : black/white (520N-4WHT and 520N-6WHT)

TEMPERATURE RANGE

-40°C up to +100°C for petroleum or synthetic hydraulic fluids.

Part No. #	DN size				mm	Max. working pressure		Min. burst pressure		Min. bend radius	Weight	Arma- turen
	mm	inch	MPa	psi		MPa	psi	mm	kg/m			
520N-3	5	-03	4.8	3/16	10.6	34.5	5,000	138.0	20,000	38	0.07	55/56
520N-4	6	-04	6.3	1/4	12.7	34.5	5,000	138.0	20,000	51	0.10	55/56
520N-5	8	-05	7.9	5/16	14.5	31.0	4,500	124.0	18,000	64	0.12	55/56
520N-6	10	-06	9.5	3/8	16.1	27.5	4,000	110.0	16,000	64	0.13	55/56
520N-8	12	-08	12.7	1/2	20.4	24.0	3,500	96.0	14,000	102	0.20	55/56
520N-4WHT	6	-04	6.3	1/4	12.7	34.5	5,000	138.0	20,000	51	0.10	55/56
520N-6WHT	10	-06	9.5	3/8	16.1	27.5	4,000	110.0	16,000	64	0.13	55/56

NOTES

- Also available as twinline or multiline hose, see page E-43.
- 520N-4WHT and 520N-6WHT with white cover.
- Not recommended for forklift boom applications.

High pressure

528N – Electrically non-conductive hose

Performance exceeds SAE 100 R8 /
ISO 3949 Type R8 / DIN EN 855 Type R8



MAIN FEATURES

- **Electrically non-conductive**
- Very small hose outer diameters
- Excellent abrasion resistance
- Small bend radii
- Low weight
- Excellent chemical resistance due to polyamide core tube

APPLICATIONS

High pressure service for general industrial and mobile hydraulic applications, where a non-conductive hose is required.

CONSTRUCTION

Core tube : Polyamide
Pressure reinforcement : One braided layer of high tensile aramide fibre
Cover : Polyurethane, not pinpricked
Colour : orange

TEMPERATURE RANGE

-40°C up to +100°C for petroleum or synthetic hydraulic fluids.

Part No. #	DN size			mm	Max. working pressure		Min. burst pressure		Min. bend radius	Weight	Arma- turen	
	mm	inch	mm		MPa / psi	MPa / psi	mm	kg/m				
528N-3	5	-03	4.8	3/16	10.6	34.5	5,000	138.0	20,000	38	0.07	55/56
528N-4	6	-04	6.3	1/4	12.7	34.5	5,000	138.0	20,000	51	0.10	55/56
528N-5	8	-05	7.9	5/16	14.5	31.0	4,500	124.0	18,000	64	0.12	55/56
528N-6	10	-06	9.5	3/8	16.1	27.5	4,000	110.0	16,000	64	0.13	55/56
528N-8	12	-08	12.7	1/2	20.4	24.0	3,500	96.0	14,000	102	0.20	55/56

NOTES

- Electrically non-conductive acc. to SAE J517 (less than 50 µA leakage under 250,000 Volts per metre).
- Not recommended for forklift boom applications.

580N – Standard hydraulic hose

Performance exceeds SAE 100 R8 /
ISO 3949 Type R8 / DIN EN 855 Type R8



MAIN FEATURES

- Excellent abrasion resistance
- Small bend radii
- Low weight
- Excellent chemical resistance due to polyamide core tube

APPLICATIONS

High pressure service for general industrial and mobile hydraulic applications as well as with gases. Usable for a wide variety of fluids due to the polyamide core tube.

CONSTRUCTION

Core tube : Polyamide
Pressure reinforcement : Multiple braided layers of high tensile synthetic fibre
Cover : Polyurethane, pinpricked
Colour : black

TEMPERATURE RANGE

-40°C up to +100°C for petroleum or synthetic hydraulic fluids.

Part No. #	DN size				mm	Max. working pressure		Min. burst pressure		Min. bend radius	Weight	Fittings
	mm	inch	MPa / psi	MPa / psi		mm	kg/m					
580N-4	6	-04	6.3	1/4	15.4	34.5	5,000	138.0	20,000	51	0.16	58
580N-6	10	-06	9.5	3/8	19.3	27.5	4,000	110.0	16,000	64	0.22	58
580N-8	12	-08	12.7	1/2	22.3	24.0	3,500	96.0	14,000	102	0.31	58
580N-10	16	-10	15.9	5/8	24.9	19.0	2,750	76.0	11,000	152	0.32	56/58
580N-12	20	-12	19.1	3/4	29.5	15.5	2,250	62.0	9,000	203	0.35	56/58
580N-16	25	-16	25.4	1	37.6	14.0	2,000	56.0	8,000	254	0.56	56/58

NOTES

Also available as twinline or multilayer hose, see page E-43.

High pressure

588N – Electrically non-conductive hose

Performance exceeds SAE 100 R8 /
ISO 3949 Type R8 / DIN EN 855 Type R8



MAIN FEATURES

- **Electrically non-conductive**
- Very small hose outer diameters
- Excellent abrasion resistance
- Small bend radii
- Low weight
- Excellent chemical resistance due to polyamide core tube

APPLICATIONS

High pressure service for general industrial and mobile hydraulic applications, where a non-conductive hose is required.

CONSTRUCTION

Core tube : Polyamide
Pressure reinforcement : Two braided layers of high tensile synthetic fibre

Cover : Polyurethane
Colour : orange

TEMPERATURE RANGE

-40°C up to +100°C for petroleum or synthetic hydraulic fluids.

Part No. #	DN	size		mm	mm	Max. working pressure		Min. burst pressure		Min. bend radius	Weight	Fittings
		mm	inch			MPa	psi	MPa	psi			
588N-4	6	-04	6.3	1/4	15.4	34.5	5,000	138.0	20,000	51	0.16	58
588N-6	10	-06	9.5	3/8	19.3	27.5	4,000	110.0	16,000	64	0.22	58
588N-8	12	-08	12.7	1/2	22.3	24.0	3,500	96.0	14,000	102	0.31	58
588N-10	16	-10	15.9	5/8	24.9	19.0	2,750	76.0	11,000	152	0.32	56/58
588N-12	20	-12	19.1	3/4	29.5	15.5	2,250	62.0	9,000	203	0.35	56/58
588N-16	25	-16	25.4	1	37.6	14.0	2,000	56.0	8,000	254	0.56	56/58

NOTES

Electrically non-conductive acc. to SAE J517 (less than 50 µA leakage under 250,000 Volts per metre).

590 – Hybrid high pressure hose

Performance exceeds SAE 100 R2



MAIN FEATURES

- Excellent abrasion resistance
- **Small bend radii**
- Special pressure reinforcement construction made of steel wire/textile fibre
- **Excellent flexibility**
- **Low weight**

APPLICATIONS

High pressure service for general industrial and mobile hydraulic applications. **Especially suited for telescoping booms of telehandlers and loading cranes** – frequently used as twinline hose.

CONSTRUCTION

Core tube : Polyester elastomer
Pressure reinforcement : One braided layer of high tensile aramide fibre and/or one braided layer of high tensile steel wire
Cover : Polyurethane
Colour : black

TEMPERATURE RANGE

-40°C up to +121°C for petroleum, max. 57°C for synthetic hydraulic fluids and water-based hydraulic fluids.

Part No. #	DN size				mm	Max. working pressure		Min. burst pressure		Min. bend radius	Weight	Fittings
	mm	inch	MPa / psi	MPa / psi								
590-3	5	-03	4.8	3/16	10.9	34.5	5,000	138.0	20,000	38	0.15	55/56
590-4	6	-04	6.3	1/4	13.0	34.5	5,000	138.0	20,000	44	0.21	55/56
590-6	10	-06	9.5	3/8	16.3	27.5	4,000	110.0	16,000	57	0.29	55/56
590-8	12	-08	12.7	1/2	19.8	24.0	3,500	96.0	14,000	83	0.37	55/56
590-10	16	-10	15.9	5/8	24.6	21.0	3,000	83.0	12,000	152	0.57	56/58
590-12	20	-12	19.1	3/4	27.9	17.5	2,500	69.0	10,000	178	0.66	56/58
590-16	25	-16	25.4	1	36.1	14.0	2,000	55.0	8,000	203	0.88	56/58

NOTES

Also available as twinline or multiline hose, see page E-43.

575X – High pressure hose

Low volumetric expansion

Same working pressure for all sizes

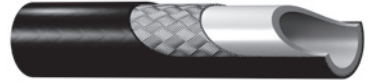

MAIN FEATURES

- **Same working pressure of 34.5 MPa for all sizes**
- Excellent abrasion resistance
- Small bend radii and very small outer diameters
- **Very low weight**
- Excellent chemical resistance due to polyamide core tube
- **Low volumetric expansion**

APPLICATIONS

High pressure service for general industrial and mobile hydraulic applications.

CONSTRUCTION

Core tube : Polyamide

Pressure reinforcement : One or two braided layers of high tensile aramide fibre

Cover : Polyurethane

Colour : black

TEMPERATURE RANGE

-40°C up to +100°C for petroleum or synthetic hydraulic fluids.

Part No. #	DN size				mm	Max. working pressure		Min. burst pressure		Min. bend radius	Weight	Volum. expans.	Fittings
	mm	inch	MPa	psi		MPa	psi	mm	kg/m				
575X-3	5	-03	4.8	3/16	10.8	34.5	5,000	138.0	20,000	38	0.07	5.2	55/56
575X-4	6	-04	6.3	1/4	12.8	34.5	5,000	138.0	20,000	51	0.10	6.9	55/56
575X-6	10	-06	9.5	3/8	16.3	34.5	5,000	138.0	20,000	76	0.13	10.2	55/56
575X-8	12	-08	12.7	1/2	20.6	34.5	5,000	138.0	20,000	102	0.20	15.1	55/56

NOTES

-

2370N/2370H – Multi purpose hose

Performance exceeds DIN EN 853-2SN



MAIN FEATURES

- Working pressures up to 46.5 MPa
- Excellent chemical resistance due to polyamide core tube

APPLICATIONS

High pressure service for general industrial and mobile hydraulic applications as well as with gases. Usable for a wide variety of fluids due to the polyamide core tube.

CONSTRUCTION

Core tube : Polyamide; alternative -08: polyester elastomer
Pressure reinforcement : Two spiral layers of high tensile steel wire, two open spiral layers of high tensile synthetic fibre
Cover : Polyurethane
Colour : black; other colours on request

TEMPERATURE RANGE

-40°C up to +100°C (short term +120°C) for petroleum or synthetic hydraulic fluids.

Part No. #	DN	size		mm	mm	Max. working pressure		Min. burst pressure		Min. bend radius	Weight	Fittings
		mm	inch			MPa / psi	MPa / psi	kg/m				
2370N-04V10	6	-04	6.3	1/4	12.4	46.5	6,740	186.0	26,970	70	0.19	NX
2370N-05V10	8	-05	8.2	5/16	14.3	44.0	6,380	176.0	25,520	100	0.25	NX
2370N-06V10	10	-06	9.8	3/8	16.4	42.0	6,090	168.0	24,360	120	0.33	9X
2370N-08V10	12	-08	12.8	1/2	20.0	35.0	5,075	140.0	20,300	150	0.42	9X
2370H-08V10	12	-08	12.8	1/2	19.6	30.0	4,350	120.0	17,400	150	0.42	9X

NOTES

- Also available as twinline or multiline hose, see page E-43.
- For pinpricked hose please add "-P", e.g. **2370N-04V10-P**.

High pressure

2245N/2244N – High pressure hose

Performance exceeds SAE100R9



MAIN FEATURES

- High working pressures for large sizes
- Excellent chemical resistance due to polyamide core tube

APPLICATIONS

High pressure service for general industrial and mobile hydraulic applications as well as with gases. Usable for a wide variety of fluids due to the polyamide core tube.

CONSTRUCTION

Core tube : Polyamide
Pressure reinforcement : Two spiral layers of high tensile steel wire, one braided layer of steel wire
Cover : Polyurethane; -10 and above: polyamide
Colour : black

TEMPERATURE RANGE

-40°C up to +100°C (short term +120°C) for petroleum or synthetic hydraulic fluids.

Part No. #	DN size				mm	Max. working pressure		Min. burst pressure		Min. bend radius	Weight	Fittings
	mm	inch	mm	inch		MPa	psi	MPa	psi			
2245N-04V00	6	-04	6.3	1/4	12.5	45.0	6,525	180.0	26,100	70	0.25	NX
2245N-05V00	8	-05	8.2	5/16	14.3	40.0	5,800	160.0	23,200	100	0.32	NX
2245N-06V00	10	-06	9.7	3/8	17.0	37.5	5,435	150.0	21,750	120	0.42	NX
2245N-08V00	12	-08	12.8	1/2	20.7	35.0	5,075	140.0	20,300	165	0.52	NX
2245N-10V30	16	-10	16.0	5/8	24.5	33.0	4,785	132.0	19,140	200	0.72	NX
2245N-12V30	20	-12	19.6	3/4	28.5	30.0	4,350	120.0	17,400	240	0.92	NX
2245N-16V30	25	-16	25.0	1	34.0	27.5	3,985	110.0	15,950	280	1.15	NX
2244N-20V30	32	-20	32.0	1 1/4	44.0	27.5	3,985	110.0	15,950	400	1.83	NX

NOTES

- 2045N and 2244N with DNV approval for hydraulic systems.
- 2244N: Higher working pressures due to improved pressure reinforcement.
- For pinpricked hose please add "-P", e.g. **2245N-04V00-P**.

Part 4 – Paint spray hose

Airless paint spray applications – General statements	E-27
2040N – Medium pressure hose	E-28
2370N – High pressure hose	E-29
2030T – PTFE hose.....	E-30
2033T – PTFE hose.....	E-31

Airless paint spray applications – General statements

Hose assembly

Hoses for airless paint spray applications require a specific assembly procedure. It is imperative to have assembly training by Parker on the individual product.

The hose assembly must be silicone-free as silicone interferes with the paint spray quality. This requirement includes all the components and the testing media.

For each hose type specific Parker hose assembly and testing instructions have to be applied.

Conductivity

The hose assemblies must be conductive in order to dissipate the electrostatic charge. The conductivity of the hose assembly must be ensured and proven (100% testing) according to the Parker specification.

2040N – Medium pressure hose

Performance exceeds DIN EN 853-1SN,
DNV approved



MAIN FEATURES

- Working pressures up to 35 MPa
- Excellent chemical resistance due to polyamide core tube
- Excellent abrasion resistance

APPLICATIONS

Medium pressure paint spray applications.

CONSTRUCTION

Core tube : Polyamide
Pressure reinforcement : One braided layer of high tensile steel wire

Cover : Polyurethane
Colour : black

TEMPERATURE RANGE

-40°C up to +80°C

Part No. #	DN	size		mm	mm	Max. working pressure		Min. burst pressure		Min. bend radius	Weight	Fittings
		mm	inch			MPa / psi	MPa / psi					
2040N-02V00	3	-02	3.2	1/8	7.0	35.0	5,075	140.0	20,300	30	0.07	PX
2040N-03V00	5	-03	4.7	3/16	9.8	34.0	4,930	136.0	19,720	30	0.11	56/PX
2040N-04V00	6	-04	6.3	1/4	11.9	31.0	4,495	124.0	17,980	40	0.16	56/PX
2040N-05V00	8	-05	8.2	5/16	14.0	25.0	3,625	100.0	14,500	50	0.21	56/PX
2040N-06V00	10	-06	9.7	3/8	15.9	24.0	3,480	96.0	13,920	60	0.24	56/PX
2040N-08V00	12	-08	12.8	1/2	19.3	18.5	2,680	74.0	10,730	75	0.29	56/PX
2040N-10V00	16	-10	16.0	5/8	23.5	14.0	2,030	56.0	8,120	110	0.39	PX
2040N-12V00	20	-12	19.4	3/4	26.7	12.5	1,810	50.0	7,250	170	0.50	PX
2040N-16V00	25	-16	25.0	1	33.5	10.0	1,450	40.0	5,800	230	0.60	PX

NOTES

Sizes -03, -04, and -06 also available with blue cover; please change Part No. to:
2040N-03V02, 2040N-04V02, or 2040N-06V02

Paint spray

2370N – High pressure hose

Performance exceeds DIN EN 853-2SN



MAIN FEATURES

- Working pressures up to 46.5 MPa
- Excellent chemical resistance due to polyamide core tube
- Excellent abrasion resistance

APPLICATIONS

High pressure paint spray applications.

CONSTRUCTION

Core tube : Polyamide
Pressure reinforcement : Two spiral layers of high tensile steel wire, two open spiral layers of synthetic fibre
Cover : Polyurethane
Colour : black

TEMPERATURE RANGE

-40°C up to +80°C

Part No. #	DN	size		mm	mm	Max. working pressure		Min. burst pressure		Min. bend radius	Weight	Fittings
		mm	inch			MPa / psi	MPa / psi	mm	kg/m			
2370N-04V10	6	-04	6.3	1/4	12.4	46.5	6,740	186.0	26,970	70	0.19	NX
2370N-05V10	8	-05	8.2	5/16	14.3	44.0	6,380	176.0	25,520	100	0.25	NX
2370N-06V10	10	-06	9.8	3/8	16.4	42.0	6,090	168.0	24,360	120	0.33	9X
2370N-08V10	12	-08	12.8	1/2	20.0	35.0	5,075	140.0	20,300	150	0.42	9X

NOTES

Sizes -04, and -06 also available with blue cover; please change Part No. to: 2370N-04V02, or 2370N-06V02

2030T – PTFE hose



MAIN FEATURES

- Working pressures up to 27.5 MPa
- Excellent chemical resistance
- Suitable for high temperatures

APPLICATIONS

Medium pressure paint spray applications.

CONSTRUCTION

Core tube : Polytetrafluoroethylene
Pressure reinforcement : One braided layer of steel wire

Cover : –

Colour : –

TEMPERATURE RANGE

-50°C up to +150°C continuous temperature
+230°C at working pressures up to 2 MPa

Part No. #	DN	size		mm	mm	Max. working pressure		Min. burst pressure		Min. bend radius	Weight	Fittings
		mm	inch			MPa / psi	MPa / psi	kg/m				
2030T-03V70	5	-03	4.7	3/16	7.8	27.5	3,985	110.0	15,950	50	0.09	YX
2030T-04V70	6	-04	6.3	1/4	9.5	24.0	3,480	96.0	13,920	75	0.13	YX
2030T-05V70	8	-05	8.2	5/16	11.5	20.0	2,900	80.0	11,600	100	0.17	YX
2030T-06V70	10	-06	9.7	3/8	13.0	17.5	2,535	70.0	10,150	120	0.19	YX
2030T-08V70	12	-08	12.8	1/2	16.7	15.0	2,175	60.0	8,700	135	0.29	YX
2030T-10V70	16	-10	16.0	5/8	20.0	12.5	1,810	50.0	7,250	160	0.34	YX
2030T-12V70	20	-12	19.4	3/4	23.5	10.0	1,450	40.0	5,800	200	0.41	YX
2030T-16V70	25	-16	25.0	1	29.0	8.0	1,160	32.0	4,640	250	0.51	YX

NOTES –

2033T – PTFE hose



MAIN FEATURES

- Improved working pressures due to two braided layers of steel wire
- Suitable for high temperatures
- Excellent chemical resistance

APPLICATIONS

Medium pressure paint spray applications.

CONSTRUCTION

Core tube : Polytetrafluoroethylene
 Pressure reinforcement : Two braided layers of steel wire

Cover : –

Colour : –

TEMPERATURE RANGE

-50°C up to +150°C continuous temperature
 +230°C at working pressures up to 2 MPa

Part No. #	DN	size		mm	inch	mm	Max. working pressure MPa / psi		Min. burst pressure MPa / psi		Min. bend radius mm	Weight kg/m	Fittings
		mm	inch				MPa	psi	MPa	psi			
2033T-04V70	6	-04	6.3	1/4	11.0	27.5	3,985	110.0	15,950	75	0.23	PX	
2033T-05V70	8	-05	8.2	5/16	13.2	25.0	3,625	100.0	14,500	100	0.26	PX	
2033T-06V70	10	-06	9.7	3/8	15.0	22.5	3,260	90.0	13,050	120	0.34	PX	
2033T-08V70	12	-08	12.8	1/2	18.6	20.0	2,900	80.0	11,600	135	0.47	PX	
2033T-10V70	16	-10	16.0	5/8	21.5	17.5	2,535	70.0	10,150	160	0.53	YX	
2033T-12V70	20	-12	19.4	3/4	25.5	15.0	2,175	60.0	8,700	200	0.69	YX	
2033T-16V70	25	-16	25.0	1	31.0	11.0	1,595	44.0	6,380	250	0.81	YX	

NOTES –

Part 5 – Gas hose

Introduction	E-33
Thermoplastic hose for applications with industrial gases	E-34
Thermoplastic hose types with specific approvals	E-36
- 2040N – Hose for CO ₂ fire extinguishing systems with GL approval	E-37
- 2040N – Hose for pre-pressurisation lines in beverage dispensing equipment	E-38
- 526BA – Breathing air refill hose	E-39
- 5CNG – Compressed natural gas dispense hose	E-40
- 8LPG – Hose for mobile applications in vehicles	E-41

Gas

Introduction

Parker thermoplastic hoses are perfectly suited for applications with industrial gases and are being used in the field for many years.

When selecting hoses for industrial gases, attention should be paid to the following three criteria:

1. Chemical resistance

Due to the high-grade core tube materials Parker thermoplastic hoses are chemically resistant to most of the industrial gases, such as acetylene, propane, butane, methane, natural gas, CNG, carbon dioxide, nitrogen and inert gases (see chemical resistance table, page A-10).

2. Permeation

Parker thermoplastic hoses have relatively low permeation rates, thus minimising the loss of gases. This leads to an optimisation of operational costs, and gas enrichments in the surroundings caused by permeation are minimised.

3. Perforation

It is mandatory for gas applications to use perforated (pinpricked) hoses in order to avoid bubble formation in the hose cover.

For further information please refer to our Engineering Standard PFDE-ES01, which is available on request at Parker Polyflex.

Thermoplastic hose for applications with industrial gases

Based on the technical requirements noted in the introduction some hose types are particularly suited for gas applications. These hose types can be classified as follows:

- 1) **Hoses with textile fibre reinforcement** – these have pinpricked covers by default:

540N	5CNG
520N	8LPG
2010N	
2020N	

- 2) **Hoses with steel wire reinforcement** – these have to be pinpricked especially for gas applications:

2040N
2370N
2245N

- 3) **Hoses with core tubes made from fluoropolymer** – these are especially suited for aggressive fluids and/or higher temperatures:

2030T
2033T
939
2246F

Please use the following table to select the desired hose type by size and working pressure.

Nom. size		Working pressure (MPa)															Fitting series	pg	
		DN	2	2.5	3	4	5	6	8	10	12	16	20	25	32	40			50
		size	-012	-016	-02	-025	-03	-04	-05	-06	-08	-10	-12	-16	-20	-24			-32
		mm	2.0	2.4	3.2	4.0	4.8	6.4	7.9	9.5	12.7	15.9	19.0	25.4	31.8	38.1			50.8
inch	5/64	3/32	1/8	5/32	3/16	1/4	5/16	3/8	1/2	5/8	3/4	1	1 1/4	1 1/2	2				
Hoses with textile fibre reinforcement																			
540N			17.5		21.0	19.0	17.5	15.5	14.0	8.5							55/56/57	E-8	
520N					34.5	34.5	31.0	27.5	24.0								55/56	E-18	
2010N	27.5																EX	E-3	
2020N (V30)	47.5	40.0	40.0	44.0													EX	E-4	
5CNG					34.5	34.5		34.5	34.5		34.5	34.5					55.58.58H	E-40	
8LPG					3.0	3.0	3.0	3.0									PX-LPG	E-41	
Hoses with steel wire reinforcement																			
2040N (V00)					34.0	31.0	25.0	24.0	18.5	14.0	12.5	10.0					56/PX	E-37	
2370N						46.5	44.0	42.0	35.0								9X/NX	E-29	
2245N						45.0	40.0	37.5	35.0	33.0	30.0	27.5					NX	E-25	
Hoses with core tubes made from fluoropolymer																			
2030T					27.5	24.0	20.0	17.5	15.0	12.5	10.0	8.0					YX	C-3	
2033T						27.5	25.0	22.5	20.0	17.5	15.0	11.0					PX/YX	C-7	
939/939B								10.3	9.5	6.9	7.5	6.9	6.9	5.0	1.7		93/93N	C-10	
2246F						41.5	37.5	34.0	32.5	30.0	26.5	21.0					NX	C-12	

Gas

For gas applications temperature limitations must be considered. For most of the gases the above Parker hose types are suitable for temperatures up to 50°C. For higher temperatures please contact Parker Polyflex.

For hose applications with gases legal and actuarial regulations must be observed. The specification of the chemical resistance does not replace approval of certain bodies or for specific applications.

The user has to assume full responsibility for hose selection, testing of the application and the environmental conditions, and release for the individual application.

Please refer also to the standards, approvals and certificates when selecting hoses (see page A-14).

Thermoplastic hose types with specific approvals

Some hose types and sizes have approvals for specific gas applications. Please refer to the following overview:

Application	Approval	Hose type	Page	Parker certificate
Mobile and fixed fire extinguishing systems with carbon dioxide (CO ₂)	German Lloyd	2040N (-03, -04, -05, -06, -08, -10, -12, -16)	E-37	PFDE-CERT01
Pre-pressurisation lines in beverage dispensing equipment	SK Zert	2040N-04V74 2040N-04V78	E-38	PFDE-CERT18
Natural gas, CNG	AGA/CSA approved acc. to ANSI 4.2/12.52	5CNG	D-2, E-40	PFDE-CERT04
	ECE R110	5CNG-3 und -8	D-2, E-40	PFDE-CERT08
LPG	ECE R67	8LPG (-3, -4, -5, -6)	D-4, E-41	PFDE-CERT07

2040N – Hose for CO₂ fire extinguishing systems with GL approval



MAIN FEATURES

- GL approval
- Excellent abrasion resistance
- Small bend radii

APPLICATIONS

Flexible connections between CO₂ gas cylinder regulators and manifolds in CO₂ fire extinguishing systems and for mobile or fixed CO₂ fire extinguishers.

CONSTRUCTION

Core tube : Polyamide
Pressure reinforcement : One braided layer of high tensile steel wire

Cover : Polyurethane, pinpricked
Colour : black

TEMPERATURE RANGE

–40 °C up to +80 °C

Part No. #	DN	size		mm	inch	mm	Max. working pressure		Min. burst pressure		Min. bend radius	Weight	Fittings
		mm	inch				MPa	psi	MPa	psi			
2040N-03V00-P	5	-03	4.7	3/16	9.8	34.0	4,930	136.0	19,720	30	0.11	56/PX	
2040N-04V00-P	6	-04	6.3	1/4	11.9	31.0	4,495	124.0	17,980	40	0.16	56/PX	
2040N-05V00-P	8	-05	8.2	5/16	14.0	25.0	3,625	100.0	14,500	50	0.21	56/PX	
2040N-06V00-P	10	-06	9.7	3/8	15.9	24.0	3,480	96.0	13,920	60	0.24	56/PX	
2040N-08V00-P	12	-08	12.8	1/2	19.3	18.5	2,680	74.0	10,730	75	0.29	56/PX	
2040N-10V00-P	16	-10	16.0	5/8	23.5	14.0	2,030	56.0	8,120	110	0.39	PX	
2040N-12V00-P	20	-12	19.4	3/4	26.7	12.5	1,810	50.0	7,250	170	0.50	PX	
2040N-16V00-P	25	-16	25.0	1	33.5	10.0	1,450	40.0	5,800	230	0.60	PX	

NOTES

Also available as twinline or multiline hose, see page E-43.

2040N – Hose for pre-pressurisation lines in beverage dispensing equipment



MAIN FEATURES

- SK approval
- Excellent abrasion resistance
- Small bend radii

APPLICATIONS

Pre-pressurisation lines for carbon dioxide, nitrogen and carbon dioxide - nitrogen mixtures in beverage dispensing equipment.

CONSTRUCTION

Core tube : Polyamide, with SK approval
Pressure reinforcement : One braided layer of high tensile steel wire
Cover : Polyurethane, pinpricked
Colour : 2040N-04V74: black, 2040N-04V78: grey

TEMPERATURE RANGE

-40 °C up to +100 °C

Part No. #	DN size				mm	Max. working pressure		Min. burst pressure		Min. bend radius	Weight	Fittings
	mm	inch	MPa / psi	MPa / psi		mm	kg/m					
2040N-04V74-P	6	-04	6.3	1/4	11.9	25.0	3,626	124.0	17,980	40	0.16	PX
2040N-04V78-P	6	-04	6.3	1/4	11.9	25.0	3,626	124.0	17,980	40	0.16	PX

NOTES

Also available as twinline or multiline hose, see page E-43.

526BA – Breathing air refill hose

Conforms to CGA G7.1-1997 “Grade E Breathing Air Standards” of the Compressed Gas Association

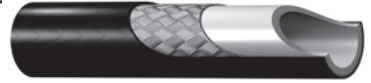

MAIN FEATURES

- Conforms to CGA G7.1-1997 “Grade E Breathing Air Standards”
- Excellent abrasion resistance
- Same working pressure of 41.4 MPa for all sizes

APPLICATIONS

- Breathing air compressors
- SCBA breathing air cylinder refilling stations
- Mobile refilling stations
- Cascade systems

CONSTRUCTION

- Core tube** : Polyamide
Pressure reinforcement : One braided layer of high tensile aramide fibre
- Cover** : Polyurethane, pinpricked
Colour : grey

TEMPERATURE RANGE

-40°C up to +82°C

Part No. #	DN size			mm	Max. working pressure		Min. burst pressure		Min. bend radius	Weight	Arma- turen	
	mm	inch	mm		MPa / psi	MPa / psi	mm	kg/m				
526BA-3	5	-03	4.8	3/16	11.0	41.4	6,000	165.5	24,000	38	0.08	55
526BA-4	6	-04	6.3	1/4	13.0	41.4	6,000	165.5	24,000	51	0.10	55
526BA-6	10	-06	9.5	3/8	16.0	41.4	6,000	165.5	24,000	76	0.13	55

NOTES

- Kink protection recommended (see page F-5)
- Also available as multiline hose (see page E-43)
- Vacuum service: 95 kPa
- For assembly use water or non-toxic soap water only. Oil based lubricants must not be used.
- **This hose must not be used between pressure regulator and breathing mask.**
- The hose is non-conductive; therefore it must not be used with explosive gases such as pure oxygen and hydrogen!
- Do not purge hoses and hose assemblies with solution agents or the like. If purging is required, use water or air only.
- Air quality depends on all system components. Even if all individual components conform to the requirements, it may happen that the assembled system does not fulfill the requirement “Grade E”. This is to be verified by the system manufacturer.

5CNG – Compressed natural gas dispense hose

According to NFPA 52, AGA 1-93 and AGA/CGA,

ANSI Standards 4.2/12.52,

Approved according to CSA ECE R110

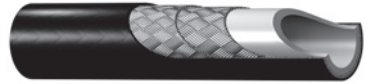

MAIN FEATURES

- High flexibility, compact construction
- Strong polyurethane cover for high wear and tear resistance
- Working pressure 34.5 MPa
- Also available as twinline or multiline hose
- Customized preforming available (see Bulletin 5200-Preformed)
- Electrically conductive

APPLICATIONS

- Dispense hose for natural gas and other gases
- Fixed applications such as refuelling hoses for natural gas fuelling stations, compressors, chemical plants or gas processing installations
- Mobile applications in vehicles

CONSTRUCTION

Core tube : Electrically conductive polymer
Pressure reinforcement : Two or more braided layers of high tensile synthetic fibre

Cover : Polyurethane, pinpricked
Colour : Red, other colours available on request

TEMPERATURE RANGE

-40°C up to +82°C

Part No. #	DN size				mm	Max. working pressure		Min. burst pressure		Min. bend radius	Weight	Fittings
	mm	inch	mm	inch		MPa / psi	MPa / psi	mm	kg/m			
5CNG-3*	5	-03	4.8	3/16	10.9	34.5	5,000	138.0	20,000	38	0.07	55
5CNG-4	6	-04	6.4	1/4	12.6	34.5	5,000	138.0	20,000	51	0.16	58
5CNG-6	10	-06	9.9	3/8	16.3	34.5	5,000	138.0	20,000	76	0.14	55
5CNG-8	12	-08	12.7	1/2	22.7	34.5	5,000	138.0	20,000	102	0.31	58
5CNG-12	20	-12	19.3	3/4	29.2	34.5	5,000	138.0	20,000	191	0.36	58H
5CNG-16	25	-16	26.0	1	40.4	34.5	5,000	138.0	20,000	254	0.53	58H

*: Only available on request

• Fittings 55 series see E-53 ff.; 58 series see E-81 ff.; Fittings 58H series available on request

• Ready-to-use refuelling hose assemblies:

5CNG-4-3000, both ends JIC 7/16 x 20 UNF, length 3 m

5CNG-6-3000, both ends JIC 9/16 x 18 UNF, length 3 m

5CNG-8-3000, both ends JIC 7/8 x 14 UNF, length 3 m

NOTES

- Not for use in paint spray applications
- For refuelling systems hose guards and warning tag must also be ordered
- Twinline constructions for return lines available
- Hose assemblies with CSA approval can be delivered ex factory or via CSA certified Parker partners
- For mobile applications 5CNG-3 or 5CNG-8 with JJ series fittings (SAE (JIC) 45° female swivel) acc. to ECE R 110 are to be used (see page D-3).

8LPG – Hose for mobile applications in vehicles

Certified acc. to ECE R 67 class 1

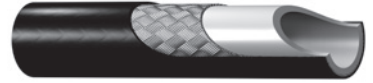

MAIN FEATURES

- Compact construction, high flexibility
- Working pressure 3.0 MPa
- Highly resistant polymer core tube
- Strong polymer cover for high wear and tear resistance, weatherproof, UV- and ozone-resistant
- Customized preforming available (see Bulletin 5200-Preformed)

APPLICATIONS

LPG-system for cars, trucks and busses

CONSTRUCTION

Core tube : Polyamide

Pressure reinforcement : One layer of high tensile synthetic fibre

Cover

: Polyamide, pinpricked; opt. flame resist. cover Type -FR(*)

Colour

: Black, other colours available on request

TEMPERATURE RANGE

-25°C up to +100°C (short term 125°C)

Part No. #	DN size		mm inch		mm	Max. working pressure MPa / psi		Min. burst pressure MPa / psi		Min. bend radius mm	Weight kg/m	Fittings
	mm	inch	mm	inch		MPa	psi	MPa	psi			
8LPG-3	5	-03	4.8	3/16	8.0	3.0	435	15.0	2,175	50	0.033	PX-LPG
8LPG-4	6	-04	6.3	1/4	9.8	3.0	435	15.0	2,175	75	0.043	PX-LPG
8LPG-5	8	-05	7.9	5/16	12.2	3.0	435	15.0	2,175	90	0.067	PX-LPG
8LPG-6	10	-06	9.5	3/8	13.7	3.0	435	15.0	2,175	100	0.075	PX-LPG
8LPG-3-FR*	5	-03	4.8	3/16	9.5	3.0	435	15.0	2,175	50	0.058	PX-LPG
8LPG-4-FR*	6	-04	6.3	1/4	11.5	3.0	435	15.0	2,175	75	0.071	PX-LPG

*Improved mechanical and chemical protection through flame resistant 2nd outer cover acc. to AS/NZS 1869

NOTES

- The hose assemblies are produced acc. to ECE R67 regulations and can be delivered ex factory or via certified Parker partners.
- For required equipment containing crimping machine for small and serial production and for certification procedure please ask your responsible Parker office.

Part 6 – Twinline and multiline hose

Twinline and multiline hose E-43

Twinline

Twinline and multiline hose

Applications

Twinline or multiline hoses ensure easier installation, and especially in applications such as fork-lift trucks, aerial lifts and hydraulic cranes they form a compact unit. On request twinline and multiline hose can be joined using various combinations of hose sizes and types.

Tools

For separating multiline hose and the appropriate tools see page H-27.

Examples

Part No. #	Part No. for twin hose #
2040H-04V10	2040H-04-04V10V10
2040H-05V10	2040H-05-05V10V10
2040H-06V10	2040H-06-06V10V10
2040H-08V10	2040H-08-08V10V10

Part No. #	Part No. for twin hose #
550H-4	550H-4-4
550H-5	550H-5-5
550H-6	550H-6-6
550H-8	550H-8-8



The following hose types are available in twinline or multiline configuration:

540N	2040H
550H	520N
1202LT	580N
55LT	2370N
590	2370H
560	5CNG

Other hose types on request.

Part 7 – Preform hose, hose coils and hose bundles

Preform hose.....	E-45
Hose coils.....	E-45
Hose bundles	E-46

Preform

1. Preform hose: **Preformed thermoplastic products from high pressure hose or thermoplastic tube**

Combines the advantages of a custom formed steel tube with the flexibility of a hose.

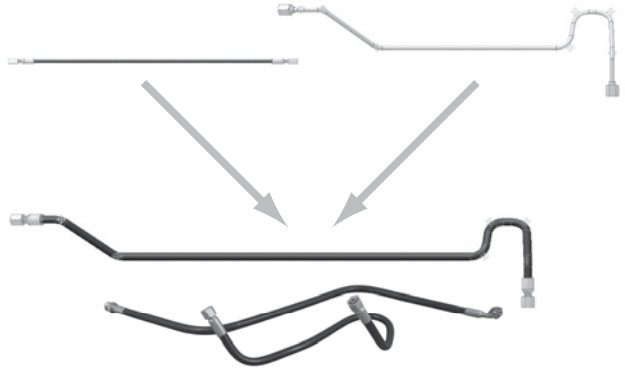

- Your advantages:**
- Improvement of efficiency
 - Cost reduction
 - Improvement of quality

Please contact us for individual custom solutions.

2. Hose coils

Hose coils from following hose types are available:

540N -3,-4,-5,-6,-8

520N -3,-4,-5



Other hose types on request.

3. Hose bundles

In Parker hose bundles, multiple hoses are combined into one compact unit. Hoses with different pressure ratings and sizes can be combined.

Options:

- With integrated electric cables
- With strain relief (avoids destructive tensile stress of the hose)
- Integrated cutting protection in the cover as safeguard for the hoses

Advantages:

- Extremely compact and space saving unit
- No abrasion between the individual hoses
- Length compensation of the hoses due to twisted construction



Part 8 – Hose fittings

54 series	E-48
55 series	E-53
56 series	E-68
57 series	E-80
58 series	E-81
9X series	E-92
AB/AF series	E-96
EX series	E-98
NX series	E-105
PX series	E-115



1C354 – Metric female swivel 24°/60° Light series – Metric swivel nut

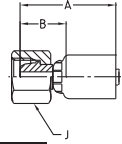

MATERIAL Galvanised steel with transparent Cr(IV)-free plating.
Other materials available on request.

Part No. #	DN size				Connection type		A mm	B mm	J mm	Max. WP MPa
	mm	inch	Thread size	Tube OD mm						
1C354-6-3	5	-03	4.8	3/16	M12x1.5	6	33	16	14	25.0
1C354-8-4	6	-04	6.4	1/4	M14x1.5	8	36	17	17	25.0
1C354-10-5	8	-05	7.9	5/16	M16x1.5	10	40	19	19	25.0
1C354-12-6	10	-06	9.5	3/8	M18x1.5	12	43	20	22	25.0

1C454 – Metric female swivel 24°/60° 45° elbow – Light series – Metric swivel nut

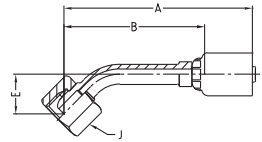

MATERIAL Galvanised steel with transparent Cr(IV)-free plating.
Other materials available on request.

Part No. #	DN size				Connection type		A mm	B mm	E mm	J mm	Max. WP MPa
	mm	inch	Thread size	Tube OD mm							
1C454-6-3	5	-03	4.8	3/16	M12x1.5	6	70	53	16	14	25.0
1C454-8-4	6	-04	6.4	1/4	M14x1.5	8	73	54	16	17	25.0
1C454-12-6	10	-06	9.5	3/8	M18x1.5	12	81	58	18	22	25.0



1C554 – Metric female swivel 24°/60°
90° elbow – Light series – Metric swivel nut

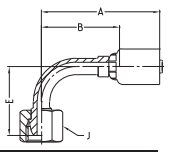

MATERIAL Galvanised steel with transparent Cr(IV)-free plating.
Other materials available on request.

Part No. #	DN size			Connection type		Tube OD mm	A mm	B mm	E mm	J mm	Max. WP MPa
	mm	inch	Thread size	Thread size							
1C554-6-3	5	-03	4.8	3/16	M12x1.5	6	51	34	32	14	25.0
1C554-8-4	6	-04	6.4	1/4	M14x1.5	8	54	36	32	17	25.0
1C554-12-6	10	-06	9.5	3/8	M18x1.5	12	60	37	35	22	25.0

54 series

1CA54 – Metric female swivel 24° with O-ring
Light series – Metric swivel nut – ISO 12151-2

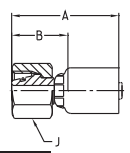

MATERIAL Galvanised steel with transparent Cr(IV)-free plating.
Other materials available on request.

Part No. #	DN size			Connection type		Tube OD mm	A mm	B mm	J mm	Max. WP MPa
	mm	inch	Thread size	Thread size						
1CA54-6-3	5	-03	4.8	3/16	M12x1.5	6	35	18	14	31.5
1CA54-8-4	6	-04	6.3	1/4	M14x1.5	8	39	20	17	42.5
1CA54-10-5	8	-05	7.9	5/16	M16x1.5	10	42	21	19	40.0
1CA54-10-6	10	-06	9.5	3/8	M16x1.5	10	44	21	19	40.0
1CA54-12-6	10	-06	9.5	3/8	M18x1.5	12	44	21	22	35.0



1CE54 – Metric female swivel 24° with O-ring 45° elbow – Light series – Metric swivel nut – ISO 12151-2

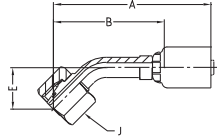

MATERIAL Galvanised steel with transparent Cr(IV)-free plating.
Other materials available on request.

Part No. #	DN size				Connection type		A mm	B mm	E mm	J mm	Max. WP MPa
	mm	inch	Thread size	Tube OD mm							
1CE54-6-3	5	-03	4.8	3/16	M12x1.5	6	65	48	17	14	31.5
1CE54-8-4	6	-04	6.3	1/4	M14x1.5	8	63	44	17	17	42.5
1CE54-10-5	8	-05	7.9	5/16	M16x1.5	10	81	60	19	19	40.0
1CE54-10-6	10	-06	9.5	3/8	M16x1.5	10	82	59	19	19	40.0
1CE54-12-6	10	-06	9.5	3/8	M18x1.5	12	82	59	19	22	35.0

1CF54 – Metric female swivel 24° with O-ring 90° elbow – Light series – Metric swivel nut – ISO 12151-2

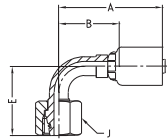

MATERIAL Galvanised steel with transparent Cr(IV)-free plating.
Other materials available on request.

Part No. #	DN size				Connection type		A mm	B mm	E mm	J mm	Max. WP MPa
	mm	inch	Thread size	Tube OD mm							
1CF54-6-3	5	-03	4.8	3/16	M12x1.5	6	45	28	31	14	31.5
1CF54-10-6	10	-06	9.5	3/8	M16x1.5	10	59	36	37	19	40.0



11D54 – Metric standpipe

Light series

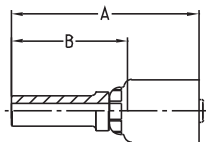

MATERIAL Galvanised steel with transparent Cr(IV)-free plating.
Other materials available on request.

Part No. #	DN	size		Tube OD mm	A mm	B mm	Max. WP MPa	
		mm	inch					
11D54-6-4	6	-04	6.3	1/4	6	49	30	25.0
11D54-8-4	6	-04	6.3	1/4	8	49	30	25.0
11D54-12-6	10	-06	9.5	3/8	12	54	31	25.0

19254 – BSP female swivel 60° cone

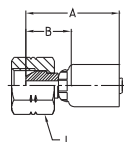

MATERIAL Galvanised steel with transparent Cr(IV)-free plating.
Other materials available on request.

Part No. #	DN	size		Connection type		A mm	B mm	J mm	Max. WP MPa
		mm	inch	Thread size	Tube OD inch				
19254-4-4	6	-04	6.3	1/4	G 1/4	36	17	19	63.0



1B154 – BSP female swivel 60° cone 45° elbow

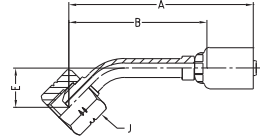

MATERIAL Galvanised steel with transparent Cr(IV)-free plating.
Other materials available on request.

Part No. #	DN size				Connection type		A mm	B mm	E mm	J mm	Max. WP MPa
	mm	inch	Thread size	Tube OD inch							
1B154-4-3	5	-03	4.8	3/16	G 1/4	1/4	70	53	16	19	63.0
1B154-4-4	6	-04	6.3	1/4	G 1/4	1/4	73	55	16	19	63.0
1B154-6-6	10	-06	9.5	3/8	G 3/8	3/8	81	58	18	22	55.0

1B254 – BSP female swivel 60° cone 90° elbow

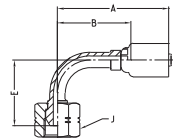

MATERIAL Galvanised steel with transparent Cr(IV)-free plating.
Other materials available on request.

Part No. #	DN size				Connection type		A mm	B mm	E mm	J mm	Max. WP MPa
	mm	inch	Thread size	Tube OD inch							
1B254-4-3	5	-03	4.8	3/16	G 1/4	1/4	51	32	32	19	63.0
1B254-4-4	6	-04	6.3	1/4	G 1/4	1/4	54	36	32	19	63.0
1B254-6-5	8	-05	7.9	5/16	G 3/8	3/8	59	38	36	22	55.0
1B254-6-6	10	-06	9.5	3/8	G 3/8	3/8	61	38	36	22	55.0

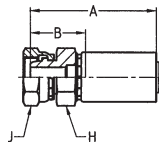
1C355 – Metric female swivel 24°/60°
Light series – Metric swivel nut

MATERIAL Galvanised steel with transparent Cr(IV)-free plating.
Other materials available on request.

Part No. #	DN size			Connection type Thread size	Tube OD mm	A mm	B mm	H mm	H mm	Max. WP MPa
	mm	inch	inch							
1C355-6-3	5	-03	4.8	M12x1.5	6	52	27	14	14	25.0
1C355-8-4	6	-04	6.4	M14x1.5	8	59	27	17	19	25.0
1C355-10-5	8	-05	7.9	M16x1.5	10	59	27	19	19	25.0
1C355-12-6	10	-06	9.5	M18x1.5	12	66	29	19	24	25.0
1C355-15-8	12	-08	12.7	M22x1.5	15	72	31	24	27	25.0
1C355-28-16	25	-16	25.4	M36x2	28	97	37	36	46	10.0

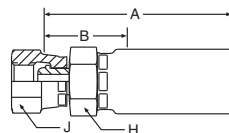
1C655 – Metric female swivel 24°/60°
Heavy series – Metric swivel nut

MATERIAL Galvanised steel with transparent Cr(IV)-free plating.
Other materials available on request.

Part No. #	DN size			Connection type Thread size	Tube OD mm	A mm	B mm	H mm	J mm	Max. WP MPa
	mm	inch	inch							
1C655-8-3	5	-03	4.8	M16x1.5	8	53	28	17	19	63.0
1C655-12-5	8	-05	7.9	M20x1.5	12	64	32	22	24	63.0
1C655-14-6	10	-06	9.5	M22x1.5	14	66	30	24	27	63.0
1C655-16-8	12	-08	12.7	M24x1.5	16	72	31	27	30	40.0

1C455 – Metric female swivel 24°/60° 45° elbow – Light series – Metric swivel nut

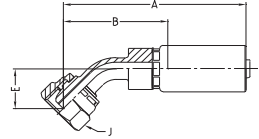

MATERIAL Galvanised steel with transparent Cr(IV)-free plating.
Other materials available on request.

Part No. #	DN size				Connection type		A mm	B mm	E mm	J mm	Max. WP MPa
	mm	inch	Thread size	Tube OD mm							
1C455-6-3	5	-03	4.8	3/16	M12x1.5	6	67	42	16	14	25.0
1C455-8-4	6	-04	6.4	1/4	M14x1.5	8	73	42	16	19	25.0
1C455-10-5	8	-05	7.9	5/16	M16x1.5	10	74	43	17	19	25.0
1C455-12-6	10	-06	9.5	3/8	M18x1.5	12	82	45	18	22	25.0
1C455-15-8	12	-08	12.7	1/2	M22x1.5	15	91	50	20	27	25.0

1C555 – Metric female swivel 24°/60° 90° elbow – Light series – Metric swivel nut

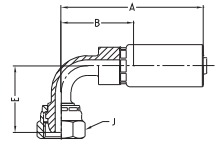

MATERIAL Galvanised steel with transparent Cr(IV)-free plating.
Other materials available on request.

Part No. #	DN size				Connection type		A mm	B mm	E mm	J mm	Max. WP MPa
	mm	inch	Thread size	Tube OD mm							
1C555-6-3	5	-03	4.8	3/16	M12x1.5	6	57	32	29	14	25.0
1C555-8-4	6	-04	6.4	1/4	M14x1.5	8	64	32	29	19	25.0
1C555-10-5	8	-05	7.9	5/16	M16x1.5	10	65	33	30	19	25.0
1C555-12-6	10	-06	9.5	3/8	M18x1.5	12	73	36	34	22	25.0
1C555-15-8	12	-08	12.7	1/2	M22x1.5	15	82	41	41	27	25.0

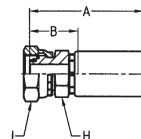
1CA55 – Metric female swivel 24° with O-ring
Light series – Metric swivel nut – ISO 12151-2

MATERIAL Galvanised steel with transparent Cr(IV)-free plating.
Other materials available on request.

Part No. #	DN	size	mm	inch	Connection type		A mm	B mm	H mm	J mm	Max. WP MPa
					Thread size 	Tube OD mm 					
1CA55-6-3	5	-03	4.8	3/16	M12x1.5	6	54	29	14	14	31.5
1CA55-8-4	6	-04	6.4	1/4	M14x1.5	8	60	29	17	19	42.5
1CA55-10-5	8	-05	7.9	5/16	M16x1.5	10	62	30	19	19	40.0
1CA55-10-6	10	-06	9.5	3/8	M16x1.5	10	67	31	19	19	40.0
1CA55-12-6	10	-06	9.5	3/8	M18x1.5	12	68	31	19	22	35.0
1CA55-15-8	12	-08	12.7	1/2	M22x1.5	15	74	33	24	27	31.5
1CA55-18-12	20	-12	19.0	3/4	M26x1.5	18	80	34	32	32	31.5
1CA55-22-12	20	-12	19.0	3/4	M30x2	22	80	34	32	36	28.0
1CA55-28-16	25	-16	25.4	1	M36x2	28	101	41	36	46	21.0

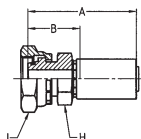
1C955 – Metric female swivel 24° with O-ring
Heavy series – Metric swivel nut – ISO 12151-2

MATERIAL Galvanised steel with transparent Cr(IV)-free plating.
Other materials available on request.

Part No. #	DN	size	mm	inch	Connection type		A mm	B mm	H mm	J mm	Max. WP MPa
					Thread size 	Tube OD mm 					
1C955-8-3	5	-03	4.8	3/16	M16x1.5	8	54	29	17	19	63.0
1C955-10-4	6	-04	6.4	1/4	M18x1.5	10	67	36	19	22	63.0
1C955-12-5	8	-05	7.9	5/16	M20x1.5	12	63	32	19	24	63.0
1C955-14-6	10	-06	9.5	3/8	M22x1.5	14	70	33	24	27	63.0
1C955-16-8	12	-08	12.7	1/2	M24x1.5	16	77	36	24	30	42.0
1C955-25-12	20	-12	19.0	3/4	M36x2	25	88	42	36	46	42.0
1C955-30-16	25	-16	25.4	1	M42x2	30	104	44	41	50	42.0

1CE55 – Metric female swivel 24° with O-ring 45° elbow – Light series – Metric swivel nut – ISO 12151-2

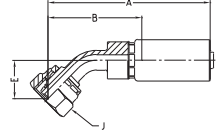

MATERIAL Galvanised steel with transparent Cr(IV)-free plating.
Other materials available on request.

Part No. #	DN size				Connection type		A mm	B mm	E mm	J mm	Max. WP MPa
	mm	inch	Thread size	Tube OD mm							
1CE55-6-3	5	-03	4.8	3/16	M12x1.5	6	67	42	16	14	31.5
1CE55-8-4	6	-04	6.4	1/4	M14x1.5	8	75	43	18	19	42.5
1CE55-10-5	8	-05	7.9	5/16	M16x1.5	10	75	44	18	19	40.0
1CE55-12-6	10	-06	9.5	3/8	M18x1.5	12	83	46	19	22	35.0
1CE55-15-8	12	-08	12.7	1/2	M22x1.5	15	92	51	21	27	31.5
1CE55-18-12	20	-12	19.0	3/4	M26x1.5	18	108	62	25	32	31.5
1CE55-22-12	20	-12	19.0	3/4	M30x2	22	108	62	26	36	28.0

1CF55 – Metric female swivel 24° with O-ring 90° elbow – Light series – Metric swivel nut – ISO 12151-2

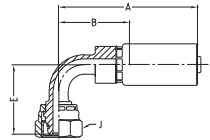

MATERIAL Galvanised steel with transparent Cr(IV)-free plating.
Other materials available on request.

Part No. #	DN size				Connection type		A mm	B mm	E mm	J mm	Max. WP MPa
	mm	inch	Thread size	Tube OD mm							
1CF55-6-3	5	-03	4.8	3/16	M12x1.5	6	55	30	29	14	31.5
1CF55-8-4	6	-04	6.4	1/4	M14x1.5	8	64	32	32	19	42.5
1CF55-10-5	8	-05	7.9	5/16	M16x1.5	10	65	33	32	19	40.0
1CF55-12-6	10	-06	9.5	3/8	M18x1.5	12	73	36	35	22	35.0
1CF55-15-8	12	-08	12.7	1/2	M22x1.5	15	82	41	42	27	31.5
1CF55-22-12	20	-12	19.0	3/4	M30x2	22	100	54	52	36	28.0
1CF55-28-16	25	-16	25.4	1	M36x2	28	122	62	65	46	21.0

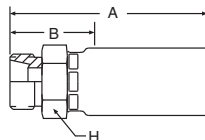
1D055 – Metric male 24°
Light series – ISO 12151-2

MATERIAL Galvanised steel with transparent Cr(IV)-free plating.
Other materials available on request.

Part No. #	DN size				Connection type		A mm	B mm	H mm	Max. WP MPa
	mm	inch	Thread size	Tube OD mm						
1D055-6-3	5	-03	4.8	3/16	M12x1.5	6	49	23	17	25.0
1D055-8-4	6	-04	6.4	1/4	M14x1.5	8	55	23	19	42.5
1D055-10-5	8	-05	7.9	5/16	M16x1.5	10	58	26	19	40.0
1D055-12-6	10	-06	9.5	3/8	M18x1.5	12	64	27	22	35.0
1D055-15-8	12	-08	12.7	1/2	M22x1.5	15	71	30	27	31.0
1D055-18-12	20	-12	19.0	3/4	M26x1.5	18	76	30	32	28.0
1D055-22-12	20	-12	19.0	3/4	M30x2	22	77	31	36	28.0

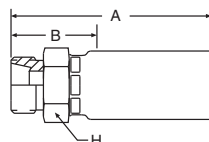
1D255 – Metric male 24°
Heavy series – ISO 12151-2

MATERIAL Galvanised steel with transparent Cr(IV)-free plating.
Other materials available on request.

Part No. #	DN size				Connection type		A mm	B mm	H mm	Max. WP MPa
	mm	inch	Thread size	Tube OD mm						
1D255-8-3	5	-03	4.8	3/16	M16x1.5	8	52	27	19	63.0
1D255-10-4	6	-04	6.4	1/4	M18x1.5	10	58	26	22	63.0
1D255-12-5	8	-05	7.9	5/16	M20x1.5	12	62	30	24	63.0
1D255-14-6	10	-06	9.5	3/8	M22x1.5	14	69	32	27	63.0
1D255-16-8	12	-08	12.7	1/2	M24x1.5	16	73	32	27	42.0
1D255-20-12	20	-12	19.0	3/4	M30x2	20	79	33	36	42.0
1D255-25-12	20	-12	19.0	3/4	M36x2	25	81	35	41	42.0



11D55 – Metric standpipe

Light series

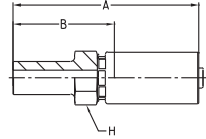

MATERIAL Galvanised steel with transparent Cr(IV)-free plating.
Other materials available on request.

Part No. #	DN	size	mm	inch	Tube OD mm	A mm	B mm	H mm	Max. WP MPa
11D55-6-3	5	-03	4.8	3/16	6	59	33	14	25.0
11D55-8-4	6	-04	6.4	1/4	8	68	37	17	25.0
11D55-10-5	8	-05	7.9	5/16	10	69	37	17	25.0
11D55-12-6	10	-06	9.5	3/8	12	75	38	19	25.0
11D55-15-8	12	-08	12.7	1/2	15	82	41	22	25.0
11D55-22-12	20	-12	19.0	3/4	22	91	45	30	16.0

⚠ Not recommended for new constructions. Please refer to end connections C3 or CA.

13D55 – Metric standpipe

Heavy series

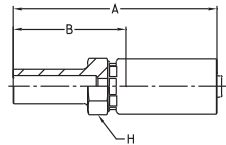

MATERIAL Galvanised steel with transparent Cr(IV)-free plating.
Other materials available on request.

Part No. #	DN	size	mm	inch	Tube OD mm	A mm	B mm	H mm	Max. WP MPa
13D55-8-3	5	-03	4.8	3/16	8	61	35	14	63.0
13D55-10-4	6	-04	6.4	1/4	10	70	38	17	63.0
13D55-12-5	8	-05	7.9	5/16	12	71	39	17	63.0
13D55-14-6	10	-06	9.5	3/8	14	81	44	19	63.0
13D55-16-8	12	-08	12.7	1/2	16	87	46	22	40.0
13D55-20-12	20	-12	19.0	3/4	20	98	52	30	40.0

⚠ Not recommended for new constructions. Please refer to end connections C9.

19255 – BSP female swivel 60° cone

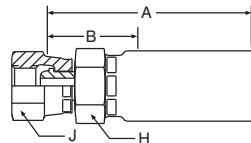

MATERIAL Galvanised steel with transparent Cr(IV)-free plating. Other materials available on request.

Part No. #	DN size				Connection type		A mm	B mm	H mm	J mm	Max. WP MPa
	mm	inch	Thread size	Tube OD inch							
19255-4-4	6	-04	6.4	1/4	G 1/4	1/4	58	26	17	19	63.0
19255-6-6	10	-06	9.5	3/8	G 3/8	3/8	64	27	19	22	55.0
19255-8-8	12	-08	12.7	1/2	G 1/2	1/2	67	30	34	27	43.0
19255-12-12	20	-12	19.0	3/4	G 3/4	3/4	81	35	32	32	35.0
19255-16-16	25	-16	25.4	1	G 1	1	99	39	36	41	28.0

1B255 – BSP female swivel 60° cone 90° elbow

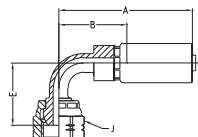

MATERIAL Galvanised steel with transparent Cr(IV)-free plating. Other materials available on request.

Part No. #	DN size				Connection type		A mm	B mm	E mm	J mm	Max. WP MPa
	mm	inch	Thread size	Tube OD inch							
1B255-4-4	6	-04	6.4	1/4	G 1/4	1/4	64	32	28	19	63.0
1B255-6-6	10	-06	9.5	3/8	G 3/8	3/8	73	36	33	22	55.0
1B255-8-8	12	-08	12.7	1/2	G 1/2	1/2	82	41	40	27	43.0
1B255-12-12	20	-12	19.0	3/4	G 3/4	3/4	100	54	53	32	35.0
1B255-16-16	25	-16	25.4	1	G 1	1	127	67	65	41	28.0

55 series



1B455 – 60° BSP female swivel 60° cone 90° compact elbow

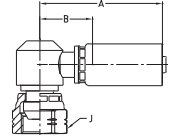

MATERIAL Galvanised steel with transparent Cr(IV)-free plating.
Other materials available on request.

Part No. #	DN	size	mm	inch	Thread size	A mm	B mm	J mm	Max. WP MPa
1B455-4-4	6	-04	6.4	1/4	G 1/4	53	21	19	63.0
1B455-6-6	10	-06	9.5	3/8	G 3/8	61	25	22	55.0
1B455-8-8	12	-08	12.7	1/2	G 1/2	68	27	27	43.0

1D955 – BSP male DIN 3852 Form A

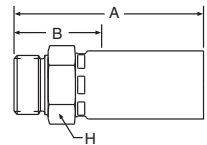

MATERIAL Galvanised steel with transparent Cr(IV)-free plating.
Other materials available on request.

Part No. #	DN	size	mm	inch	Connection type		A mm	B mm	H mm	Max. WP MPa
					Thread size	Tube OD inch				
1D955-4-4	6	-04	6.4	1/4	G 1/4	1/4	58	26	19	63.0
1D955-6-6	10	-06	9.5	3/8	G 3/8	3/8	64	27	22	55.0
1D955-8-8	12	-08	12.7	1/2	G 1/2	1/2	72	31	27	43.0
1D955-12-12	20	-12	19.0	3/4	G 3/4	3/4	80	34	32	35.0
1D955-16-16	25	-16	25.4	1	G 1	1	95	35	41	28.0

10155 – National Pipe Tapered (NPT) male

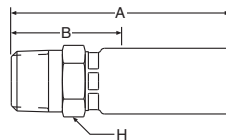

MATERIAL Galvanised steel with transparent Cr(IV)-free plating.
Other materials available on request.

Part No. #	DN size				Connection type		A mm	B mm	H mm	Max. WP MPa
	mm	inch	Thread size	Tube OD inch						
10155-2-3	5	-03	4.8	3/16	1/8 - 27NPTF	1/8	51	26	14	34.5
10155-4-3	5	-03	4.8	3/16	1/4 - 18NPTF	1/4	55	30	17	34.5
10155-6-3	5	-03	4.8	3/16	3/8 - 18NPTF	3/8	54	29	19	27.5
10155-2-4	6	-04	6.4	1/4	1/8 - 27NPTF	1/8	54	22	17	34.5
10155-4-4	6	-04	6.4	1/4	1/4 - 18NPTF	1/4	62	30	17	34.5
10155-6-4	6	-04	6.4	1/4	3/8 - 18NPTF	3/8	61	29	19	27.5
10155-4-5	8	-05	7.9	5/16	1/4 - 18NPTF	1/4	59	27	17	34.5
10155-6-5	8	-05	7.9	5/16	3/8 - 18NPTF	3/8	61	29	19	27.5
10155-4-6	10	-06	9.5	3/8	1/4 - 18NPTF	1/4	66	30	19	34.5
10155-6-6	10	-06	9.5	3/8	3/8 - 18NPTF	3/8	70	33	19	27.5
10155-8-6	10	-06	9.5	3/8	1/2 - 14NPTF	1/2	77	40	27	24.0
10155-6-8	12	-08	12.7	1/2	3/8 - 18NPTF	3/8	71	30	22	27.5
10155-8-8	12	-08	12.7	1/2	1/2 - 14NPTF	1/2	77	36	27	24.0
10155-12-12	20	-12	19.0	3/4	3/4 - 14NPTF	3/4	82	36	30	21.0
10155-16-16	25	-06	25.4	1	1 - 11 1/2NPTF	1	104	44	41	17.0



10355 – SAE (JIC) 37° male

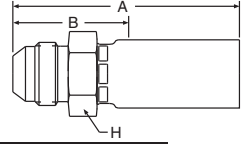

MATERIAL Galvanised steel with transparent Cr(IV)-free plating.
Other materials available on request.

Part No. #	DN size				Connection type		A mm	B mm	H mm	Max. WP MPa
	mm	inch	Thread size	Tube OD inch						
10355-4-3	5	-03	4.8	3/16	7/16 - 20UNF	1/4	52	27	14	41.0
10355-4-4	6	-04	6.4	1/4	7/16 - 20UNF	1/4	58	27	17	41.0
10355-5-4	6	-04	6.4	1/4	1/2 - 20UNF	5/16	58	27	17	41.0
10355-6-4	6	-04	6.4	1/4	1/2 - 20UNF	5/16	59	27	17	34.5
10355-5-5	8	-05	7.9	5/16	9/16 - 18UNF	3/8	62	30	17	41.0
10355-6-5	8	-05	7.9	5/16	9/16 - 18UNF	3/8	62	30	17	34.5
10355-6-6	10	-06	9.5	3/8	9/16 - 18UNF	3/8	70	33	19	34.5
10355-8-6	10	-06	9.5	3/8	3/4 - 16UNF	1/2	68	32	22	34.5
10355-8-8	12	-08	12.7	1/2	3/4 - 16UNF	1/2	73	32	22	34.5
10355-10-8	12	-08	12.7	1/2	7/8 - 14UNF	5/8	81	40	27	34.5
10355-12-12	20	-12	19.0	3/4	1 1/16 - 12UNF	3/4	84	38	30	34.5
10355-16-16	25	-06	25.4	1	1 5/16 - 12UNF	1	104	44	36	27.5

10555 – UNF male with O-ring

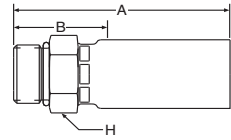

MATERIAL Galvanised steel with transparent Cr(IV)-free plating.
Other materials available on request.

Part No. #	DN size				Connection type		A mm	B mm	H mm	Max. WP MPa
	mm	inch	Thread size	Tube OD inch						
10555-4-3	5	-03	4.8	3/16	7/16 - 20UNF	1/4	47	22	14	41.0
10555-4-4	6	-04	6.4	1/4	7/16 - 20UNF	1/4	57	25	17	41.0
10555-5-4	6	-04	6.4	1/4	1/2 - 20UNF	5/16	54	22	17	41.0
10555-6-4	6	-04	6.4	1/4	9/16 - 18UNF	3/8	58	26	19	34.5
10555-4-5	8	-05	7.9	5/16	7/16 - 20UNF	1/4	53	22	17	41.0
10555-5-5	8	-05	7.9	5/16	1/2 - 20UNF	5/16	53	22	17	41.0
10555-6-6	10	-06	9.5	3/8	9/16 - 18UNF	3/8	61	25	19	34.5
10555-8-6	10	-06	9.5	3/8	3/4 - 16UNF	1/2	63	26	22	34.5
10555-8-8	12	-08	12.7	1/2	3/4 - 16UNF	1/2	67	26	22	34.5
10555-10-8	12	-08	12.7	1/2	7/8 - 14UNF	5/8	70	29	24	34.5

55 series

10655 – SAE (JIC) 37° female swivel
UNF swivel nut

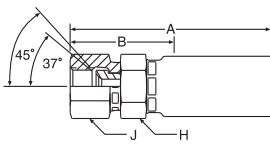

MATERIAL Galvanised steel with transparent Cr(IV)-free plating.
For stainless steel (AISI 316) please add **C** to the Part No. Example: 10655-4-3**C**.
Other materials available on request.

Part No. #	DN size				Connection type		A mm	B mm	H mm	J mm	Max. WP MPa
	mm	inch	Thread size	Tube OD inch							
10655-4-2	3	-02	3.2	1/8	7/16 - 20UNF	1/4	44	27	13	16	41.0
10655-4-3	5	-03	4.8	3/16	7/16 - 20UNF	1/4	55	30	16	17	41.0
10655-5-3	5	-03	4.8	3/16	1/2 - 20UNF	5/16	57	32	16	17	41.0
10655-4-4	6	-04	6.4	1/4	7/16 - 20UNF	1/4	65	33	17	17	41.0
10655-5-4	6	-04	6.4	1/4	1/2 - 20UNF	5/16	65	33	16	17	41.0
10655-6-4	6	-04	6.4	1/4	9/16 - 18UNF	3/8	67	35	17	19	34.5
10655-5-5	8	-05	7.9	5/16	1/2 - 20UNF	5/16	65	33	16	17	41.0
10655-6-5	8	-05	7.9	5/16	9/16 - 18UNF	3/8	65	33	16	19	34.5
10655-8-5	8	-05	7.9	5/16	3/4 - 16UNF	1/2	68	37	19	22	34.5
10655-6-6	10	-06	9.5	3/8	9/16 - 18UNF	3/8	69	33	19	19	34.5
10655-8-6	10	-06	9.5	3/8	3/4 - 16UNF	1/2	72	35	19	24	34.5
10655-6-8	12	-08	12.7	1/2	9/16 - 18UNF	3/8	76	35	22	19	34.5
10655-8-8	12	-08	12.7	1/2	3/4 - 16UNF	1/2	79	38	22	22	34.5
10655-10-8	12	-08	12.7	1/2	7/8 - 14UNF	5/8	82	41	22	27	34.5
10655-12-8	12	-08	12.7	1/2	1 1/16 - 12UNF	3/4	83	42	27	32	34.5
10655-12-12	20	-12	19.0	3/4	1 1/16 - 12UNF	3/4	88	42	30	32	34.5
10655-16-16	25	-16	25.4	1	1 5/16 - 12UNF	1	104	44	36	38	27.5

55 series

13755 – SAE (JIC) 37° female swivel 45° elbow – UNF swivel nut

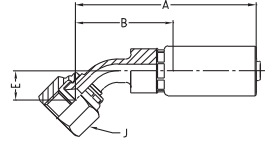

MATERIAL Galvanised steel with transparent Cr(IV)-free plating.
Other materials available on request.

Part No. #	DN size				Connection type		A mm	B mm	E mm	J mm	Max. WP MPa
	mm	inch	Thread size	Tube OD inch							
13755-4-3-SM	5	-03	4.8	3/16	7/16 - 20UNF	1/4	61	30	11	17	41.0
13755-4-4-SM	6	-04	6.4	1/4	7/16 - 20UNF	1/4	68	36	10	17	41.0
13755-5-4-SM	6	-04	6.4	1/4	1/2 - 20UNF	5/16	70	38	13	17	41.0
13755-6-5-SM	8	-05	7.9	5/16	9/16 - 18UNF	3/8	69	37	11	19	34.5
13755-6-6-SM	10	-06	9.5	3/8	9/16 - 18UNF	3/8	77	40	14	19	34.5
13755-8-6-SM	10	-06	9.5	3/8	3/4 - 16UNF	1/2	78	42	15	22	34.5
13755-8-8-SM	12	-08	12.7	1/2	3/4 - 16UNF	1/2	83	42	14	22	34.5
13755-10-8-SM	12	-08	12.7	1/2	7/8 - 14UNF	5/8	85	44	16	27	34.5
13755-12-12-SM	20	-12	19.0	3/4	1 1/16 - 12UNF	3/4	100	54	20	32	34.5
13755-16-16-SM	25	-16	25.4	1	1 5/16 - 12UNF	1	124	64	24	41	27.5

13955 – SAE (JIC) 37° female swivel 90° elbow – UNF swivel nut

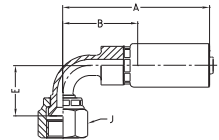

MATERIAL Galvanised steel with transparent Cr(IV)-free plating.
Other materials available on request.

Part No. #	DN size				Connection type		A mm	B mm	E mm	J mm	Max. WP MPa
	mm	inch	Thread size	Tube OD inch							
13955-4-3-SM	5	-03	4.8	3/16	7/16 - 20UNF	1/4	55	30	21	17	41.0
13955-4-4-SM	6	-04	6.4	1/4	7/16 - 20UNF	1/4	64	32	21	17	41.0
13955-5-4-SM	6	-04	6.4	1/4	1/2 - 20UNF	5/16	64	32	25	17	41.0
13955-6-4-SM	6	-04	6.4	1/4	9/16 - 18UNF	3/8	64	32	22	19	34.5
13955-6-5-SM	8	-05	7.9	5/16	9/16 - 18UNF	3/8	65	33	22	19	34.5
13955-6-6-SM	10	-06	9.5	3/8	9/16 - 18UNF	3/8	73	36	28	19	34.5
13955-8-6-SM	10	-06	9.5	3/8	3/4 - 16UNF	1/2	71	34	29	22	34.5
13955-8-8-SM	12	-08	12.7	1/2	3/4 - 16UNF	1/2	77	36	29	22	34.5
13955-10-8-SM	12	-08	12.7	1/2	7/8 - 14UNF	5/8	77	36	32	27	34.5
13955-12-12-SM	20	-12	19.0	3/4	1 1/16 - 12UNF	3/4	97	51	46	32	34.5
13955-16-16-SM	25	-16	25.4	1	1 5/16 - 12UNF	1	121	61	55	41	27.5

1JC55 – O-Lok® ORFS swivel nut

Short version – UNF swivel nut – ISO 12151-1

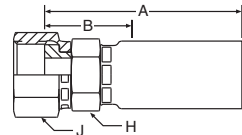

MATERIAL Galvanised steel with transparent Cr(IV)-free plating.
Other materials available on request.

Part No. #	DN size			Thread size	Connection type		A mm	B mm	H mm	J mm	Max. WP MPa
	mm	inch	inch		Thread size	Tube OD inch					
1JC55-4-3-SM	5	-03	4.8	3/16	9/16 - 18UNF	1/4	47	22	17	17	41.0
1JC55-4-4-SM	6	-04	6.4	1/4	9/16 - 18UNF	1/4	53	22	17	17	41.0
1JC55-6-4-SM	6	-04	6.4	1/4	11/16 - 16UNF	3/8	59	27	19	22	41.0
1JC55-4-5-SM	8	-05	7.9	5/16	9/16 - 16UNF	1/4	53	22	17	17	41.0
1JC55-6-5-SM	8	-05	7.9	5/16	11/16 - 16UNF	3/8	56	25	19	22	41.0
1JC55-6-6-SM	10	-06	9.5	3/8	11/16 - 16UNF	3/8	61	25	19	22	41.0
1JC55-8-6-SM	10	-06	9.5	3/8	13/16 - 16UNF	1/2	63	27	22	24	41.0
1JC55-8-8-SM	12	-08	12.7	1/2	13/16 - 16UNF	1/2	69	27	24	24	41.0
1JC55-10-8-SM	12	-08	12.7	1/2	1 - 14UNF	5/8	73	32	30	30	41.0
1JC55-12-12-SM	20	-12	19.0	3/4	1 3/16 - 12UNF	3/4	79	33	32	36	41.0
1JC55-16-16-SM	25	-16	25.4	1	1 7/16 - 12UNF	1	96	36	36	41	41.0

55 series

1JS55 – O-Lok® ORFS swivel nut

Long version – UNF swivel nut – ISO 12151-1

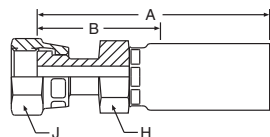

MATERIAL Galvanised steel with transparent Cr(IV)-free plating.
Other materials available on request.

Part No. #	DN size			Thread size	Connection type		A mm	B mm	H mm	J mm	Max. WP MPa
	mm	inch	inch		Thread size	Tube OD inch					
1JS55-4-3-SM	5	-03	4.8	3/16	9/16 - 18UNF	1/4	60	35	17	17	41.0
1JS55-4-4-SM	6	-04	6.4	1/4	9/16 - 18UNF	1/4	67	35	17	17	41.0
1JS55-6-4-SM	6	-04	6.4	1/4	11/16 - 16UNF	3/8	66	35	19	22	41.0
1JS55-4-5-SM	8	-05	7.9	5/16	9/16 - 16UNF	1/4	67	35	17	17	41.0
1JS55-6-5-SM	8	-05	7.9	5/16	11/16 - 16UNF	3/8	66	35	19	22	41.0
1JS55-6-6-SM	10	-06	9.5	3/8	11/16 - 16UNF	3/8	71	35	19	22	41.0
1JS55-8-6-SM	10	-06	9.5	3/8	13/16 - 16UNF	1/2	75	38	22	24	41.0
1JS55-8-8-SM	12	-08	12.7	1/2	13/16 - 16UNF	1/2	80	38	22	24	41.0
1JS55-10-10-SM	16	-10	15.9	5/8	1 - 14UNF	5/8	90	44	30	30	41.0
1JS55-12-12-SM	20	-12	19.0	3/4	1 3/16 - 12UNF	3/4	94	48	32	36	41.0
1JS55-16-16-SM	25	-16	25.4	1	1 7/16 - 12UNF	1	112	52	36	41	41.0



1J055 – O-Lok® ORFS male

ISO 12151-1

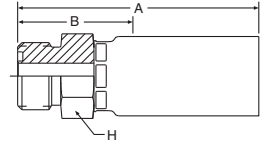

MATERIAL Galvanised steel with transparent Cr(IV)-free plating.
Other materials available on request.

Part No. #	DN size				Connection type		A mm	B mm	H mm	Max. WP MPa
	mm	inch	Thread size	Tube OD inch						
1J055-4-4-SM	6	-04	6.4	1/4	9/16 - 18UNF	1/4	56	24	19	41.0
1J055-6-6-SM	10	-06	9.5	3/8	11/16 - 16UNF	3/8	63	26	19	41.0
1J0 55-8-6-SM	10	-06	9.5	3/8	13/16 - 16UNF	1/2	65	28	22	41.0

1J755 – O-Lok® ORFS swivel nut

45° elbow – UNF swivel nut – ISO 12151-1

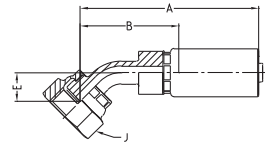

MATERIAL Galvanised steel with transparent Cr(IV)-free plating.
Other materials available on request.

Part No. #	DN size				Connection type		A mm	B mm	E mm	J mm	Max. WP MPa
	mm	inch	Thread size	Tube OD inch							
1J755-4-4	6	-04	6.4	1/4	9/16 - 18UNF	5/16	71	39	10	17	41.0
1J755-6-4	6	-04	6.4	1/4	11/16 - 16UNF	3/8	73	41	12	22	41.0
1J755-6-6	10	-06	9.5	3/8	11/16 - 16UNF	3/8	78	41	14	22	41.0
1J755-8-6	10	-06	9.5	3/8	13/16 - 16UNF	1/2	78	42	14	24	41.0
1J755-8-8	12	-08	12.7	1/2	13/16 - 16UNF	1/2	83	42	12	24	41.0
1J755-12-12	20	-12	19.0	3/4	1 3/16 - 12UNF	3/4	103	57	21	36	41.0
1J755-16-16	25	-16	25.4	1	1 7/16 - 12UNF	1	130	70	26	41	41.0

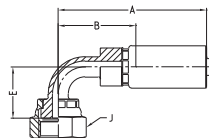
1J955 – O-Lok® ORFS swivel nut
90° elbow – UNF swivel nut – ISO 12151-1

MATERIAL Galvanised steel with transparent Cr(IV)-free plating.
Other materials available on request.

Part No. #	DN size				Connection type		A mm	B mm	E mm	J mm	Max. WP MPa
	mm	inch	Thread size	Tube OD inch							
1J955-4-4	6	-04	6.4	1/4	9/16 - 18UNF	5/16	67	35	21	17	41.0
1J955-6-4	6	-04	6.4	1/4	11/16 - 16UNF	3/8	68	36	23	22	41.0
1J955-6-5	8	-05	7.9	5/16	11/16 - 16UNF	3/8	67	35	23	22	41.0
1J955-6-6	10	-06	9.5	3/8	11/16 - 16UNF	3/8	72	36	29	22	41.0
1J955-8-8	12	-08	12.7	1/2	13/16 - 16UNF	1/2	82	41	29	24	41.0
1J955-12-12	20	-12	19.0	3/4	1 3/16 - 12UNF	3/4	100	54	47	36	41.0
1J955-16-16	25	-16	25.4	1	1 7/16 - 12UNF	1	128	68	64	41	41.0

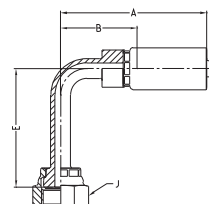
1J155 – O-Lok® ORFS swivel nut
90° elbow – Long drop length – UNF swivel nut – ISO 12151-1

MATERIAL Galvanised steel with transparent Cr(IV)-free plating.
Other materials available on request.

Part No. #	DN size				Connection type		A mm	B mm	E mm	J mm	Max. WP MPa
	mm	inch	Thread size	Tube OD inch							
1J155-4-4	6	-04	6.4	1/4	9/16 - 18UNF	5/16	67	35	46	17	41.0
1J155-6-6	10	-06	9.5	3/8	11/16 - 16UNF	3/8	72	36	54	22	41.0
1J155-8-6	10	-06	9.5	3/8	13/16 - 16UNF	1/2	72	36	64	24	41.0
1J155-8-8	12	-08	12.7	1/2	13/16 - 16UNF	1/2	82	41	64	24	41.0
1J155-12-12	20	-12	19.0	3/4	1 3/16 - 12UNF	3/4	100	54	96	36	41.0
1J155-16-16	25	-16	25.4	1	1 7/16 - 12UNF	1	128	68	114	41	41.0

1C356 – Metric female swivel 24°/60°

Light series – Metric swivel nut

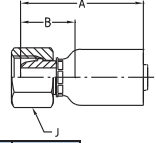

MATERIAL Galvanised steel with transparent Cr(IV)-free plating.
Other materials available on request.

Part No. #	DN size				Connection type		A mm	B mm	J mm	Max. WP MPa
	mm	inch	Thread size	Tube OD mm						
1C356-6-3	5	-03	4.8	3/16	M12x1.5	6	37	20	14	25.0
1C356-8-4	6	-04	6.4	1/4	M14x1.5	8	44	20	17	25.0
1C356-10-4	6	-04	6.4	1/4	M16x1.5	10	45	21	19	25.0
1C356-10-5	8	-05	7.9	5/16	M16x1.5	10	46	20	19	25.0
1C356-12-5	8	-05	7.9	5/16	M18x1.5	12	47	21	22	25.0
1C356-10-6	10	-06	9.5	3/8	M16x1.5	10	46	20	19	25.0
1C356-12-6	10	-06	9.5	3/8	M18x1.5	12	47	22	22	25.0
1C356-15-8	12	-08	12.7	1/2	M22x1.5	15	50	23	27	25.0
1C356-18-12	20	-12	19.0	3/4	M26x1.5	18	58	24	32	16.0
1C356-22-12	20	-12	19.0	3/4	M30x2	22	57	24	36	16.0
1C356-28-16	25	-16	25.4	1	M36x2	28	76	28	41	10.0

1C656 – Metric female swivel 24°/60°

Heavy series – Metric swivel nut

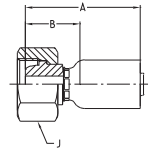

MATERIAL Galvanised steel with transparent Cr(IV)-free plating.
Other materials available on request.

Part No. #	DN size				Connection type		A mm	B mm	J mm	Max. WP MPa
	mm	inch	Thread size	Tube OD mm						
1C656-8-3	5	-03	4.8	3/16	M16x1.5	8	37	20	19	63.0
1C656-10-4	6	-04	6.4	1/4	M18x1.5	10	46	22	22	63.0
1C656-12-5	8	-05	7.9	5/16	M20x1.5	12	50	24	24	63.0
1C656-12-6	10	-06	9.5	3/8	M20x1.5	12	50	24	24	63.0
1C656-14-6	10	-06	9.5	3/8	M22x1.5	14	49	24	27	63.0
1C656-16-8	12	-08	12.7	1/2	M24x1.5	16	53	27	30	40.0
1C656-20-12	20	-12	19.0	3/4	M30x2	20	61	27	36	40.0

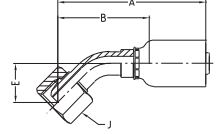
1C456 – Metric female swivel 24°/60°
45° elbow – Light series – Metric swivel nut

MATERIAL Galvanised steel with transparent Cr(IV)-free plating.
Other materials available on request.

Part No. #	DN size				Connection type		A mm	B mm	E mm	J mm	Max. WP MPa
	mm	inch	Thread size	Tube OD mm							
1C456-6-3	5	-03	4.8	3/16	M12x1.5	6	57	39	16	14	25.0
1C456-8-4	6	-04	6.4	1/4	M14x1.5	8	62	38	16	17	25.0
1C456-10-5	8	-05	7.9	5/16	M16x1.5	10	67	41	17	19	25.0
1C456-10-6	10	-06	9.5	3/8	M16x1.5	10	67	41	17	19	25.0
1C456-12-6	10	-06	9.5	3/8	M18x1.5	12	68	43	18	22	25.0
1C456-15-8	12	-08	12.7	1/2	M22x1.5	15	76	47	19	27	25.0

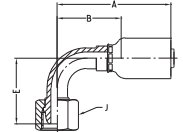
1C556 – Metric female swivel 24°/60°
90° elbow – Light series – Metric swivel nut

MATERIAL Galvanised steel with transparent Cr(IV)-free plating.
Other materials available on request.

Part No. #	DN size				Connection type		A mm	B mm	E mm	J mm	Max. WP MPa
	mm	inch	Thread size	Tube OD mm							
1C556-6-3	5	-03	4.8	3/16	M12x1.5	6	46	28	28	14	25.0
1C556-8-4	6	-04	6.4	1/4	M14x1.5	8	53	29	28	17	25.0
1C556-10-4	6	-04	6.4	1/4	M16x1.5	10	53	29	29	19	25.0
1C556-10-5	8	-05	7.9	5/16	M16x1.5	10	58	33	33	19	25.0
1C556-10-6	10	-06	9.5	3/8	M16x1.5	10	58	33	33	19	25.0
1C556-12-6	10	-06	9.5	3/8	M18x1.5	12	58	33	34	22	25.0
1C556-15-6	10	-06	9.5	3/8	M22x1.5	15	58	33	34	27	25.0
1C556-15-8	12	-08	12.7	1/2	M22x1.5	15	68	40	39	27	25.0
1C556-18-12	20	-12	19.0	3/4	M26x1.5	18	87	53	52	32	16.0

1CA56 – Metric female swivel 24° with O-ring

Light series – Metric swivel nut – ISO 12151-2

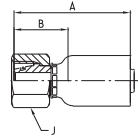

MATERIAL Galvanised steel with transparent Cr(IV)-free plating.
Other materials available on request.

Part No. #	DN size				Connection type		A mm	B mm	J mm	Max. WP MPa
	mm	inch	Thread size	Tube OD mm						
1CA56-6-3	5	-03	4.8	3/16	M12x1.5	6	39	22	14	31.5
1CA56-6-4	6	-04	6.4	1/4	M12x1.5	6	48	24	14	31.5
1CA56-8-4	6	-04	6.4	1/4	M14x1.5	8	47	23	17	42.5
1CA56-10-4	6	-04	6.4	1/4	M16x1.5	10	47	22	19	40.0
1CA56-10-5	8	-05	7.9	5/16	M16x1.5	10	48	22	19	40.0
1CA56-12-5	8	-05	7.9	5/16	M18x1.5	12	48	23	22	35.0
1CA56-10-6	10	-06	9.5	3/8	M16x1.5	10	48	23	19	40.0
1CA56-12-6	10	-06	9.5	3/8	M18x1.5	12	48	23	22	35.0
1CA56-15-8	12	-08	12.7	1/2	M22x1.5	15	52	24	27	31.5
1CA56-18-8	12	-08	12.7	1/2	M26x1.5	18	53	25	32	31.5
1CA56-18-12	20	-12	19.0	3/4	M26x1.5	18	60	26	32	31.5
1CA56-22-12	20	-12	19.0	3/4	M30x2	22	62	28	36	28.0
1CA56-28-16	25	-16	25.4	1	M36x2	28	78	30	46	21.0

1C956 – Metric female swivel 24° with O-ring

Heavy series – Metric swivel nut – ISO 12151-2

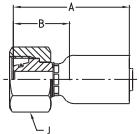

MATERIAL Galvanised steel with transparent Cr(IV)-free plating.
Other materials available on request.

Part No. #	DN size				Connection type		A mm	B mm	J mm	Max. WP MPa
	mm	inch	Thread size	Tube OD mm						
1C956-8-3	5	-03	4.8	3/16	M16x1.5	8	41	23	19	63.0
1C956-8-4	6	-04	6.4	1/4	M16x1.5	8	48	23	19	63.0
1C956-10-4	6	-04	6.4	1/4	M18x1.5	10	48	23	22	63.0
1C956-12-4	6	-04	6.4	1/4	M20x1.5	12	49	24	24	63.0
1C956-10-5	8	-05	7.9	5/16	M18x1.5	10	49	23	22	63.0
1C956-12-5	8	-05	7.9	5/16	M20x1.5	12	50	24	24	63.0
1C956-12-6	10	-06	9.5	3/8	M20x1.5	12	49	24	24	63.0
1C956-14-6	10	-06	9.5	3/8	M22x1.5	14	49	24	27	63.0
1C956-16-8	12	-08	12.7	1/2	M24x1.5	16	55	27	30	42.0
1C956-20-12	20	-12	19.0	3/4	M30x2	20	65	31	36	42.0
1C956-25-12	20	-12	19.0	3/4	M36x2	25	66	33	46	42.0

1CE56 – Metric female swivel 24° with O-ring

45° elbow – Light series – Metric swivel nut – ISO 12151-2

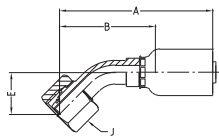

MATERIAL Galvanised steel with transparent Cr(IV)-free plating.
Other materials available on request.

Part No. #	DN size				Connection type		A mm	B mm	E mm	J mm	Max. WP MPa
	mm	inch	Thread size	Tube OD mm							
1CE56-6-3	5	-03	4.8	3/16	M12x1.5	6	58	40	17	14	31.5
1CE56-8-4	6	-04	6.4	1/4	M14x1.5	8	65	40	18	17	42.5
1CE56-10-4	6	-04	6.4	1/4	M16x1.5	10	64	40	17	19	40.0
1CE56-10-5	8	-05	7.9	5/16	M16x1.5	10	66	40	18	19	40.0
1CE56-10-6	10	-06	9.5	3/8	M16x1.5	10	68	43	19	19	40.0
1CE56-12-6	10	-06	9.5	3/8	M18x1.5	12	69	44	19	22	35.0
1CE56-15-8	12	-08	12.7	1/2	M22x1.5	15	77	49	21	27	31.5
1CE56-18-12	20	-12	19.0	3/4	M26x1.5	18	95	61	25	32	31.5
1CE56-22-12	20	-12	19.0	3/4	M30x2	22	96	62	26	36	28.0

56 series

10C56 – Metric female swivel 24° with O-ring

45° elbow – Heavy series – Metric swivel nut – ISO 12151-2

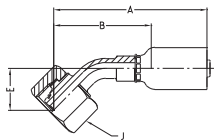

MATERIAL Galvanised steel with transparent Cr(IV)-free plating.
Other materials available on request.

Part No. #	DN size				Connection type		A mm	B mm	E mm	J mm	Max. WP MPa
	mm	inch	Thread size	Tube OD mm							
10C56-8-3	5	-03	4.8	3/16	M16x1.5	8	59	41	18	19	63.0
10C56-10-4	6	-04	6.4	1/4	M18x1.5	10	65	40	18	22	63.0
10C56-12-5	8	-05	7.9	5/16	M20x1.5	12	70	45	19	24	63.0
10C56-12-6	10	-06	9.5	3/8	M20x1.5	12	70	45	20	24	63.0
10C56-16-8	12	-08	12.7	1/2	M24x1.5	16	80	51	23	30	42.0

1CF56 – Metric female swivel 24° with O-ring

90° elbow – Light series – Metric swivel nut – ISO 12151-2

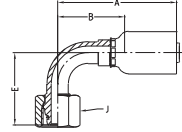

MATERIAL Galvanised steel with transparent Cr(IV)-free plating.
Other materials available on request.

Part No. #	DN size				Connection type		A mm	B mm	E mm	J mm	Max. WP MPa
	mm	inch	Thread size	Tube OD mm							
1CF56-6-3	5	-03	4.8	3/16	M12x1.5	6	46	28	30	14	31.5
1CF56-6-4	6	-04	6.4	1/6	M12x1.5	6	53	29	33	14	31.5
1CF56-8-4	6	-04	6.4	1/6	M14x1.5	8	53	29	32	17	42.5
1CF56-10-4	6	-04	6.4	1/6	M16x1.5	10	53	29	31	19	40.0
1CF56-10-5	8	-05	7.9	5/16	M16x1.5	10	55	30	32	19	40.0
1CF56-12-5	8	-05	7.9	5/16	M18x1.5	12	56	30	33	22	35.0
1CF56-10-6	10	-06	9.5	3/8	M16x1.5	10	58	33	35	19	40.0
1CF56-12-6	10	-06	9.5	3/8	M18x1.5	12	58	36	33	22	35.0
1CF56-15-8	12	-08	12.7	1/2	M22x1.5	15	68	40	41	27	31.5
1CF56-18-12	20	-12	19.0	3/4	M26x1.5	18	87	54	53	32	31.5
1CF56-22-12	20	-12	19.0	3/4	M30x2	22	87	54	65	36	28.0
1CF56-28-16	25	-16	25.4	1	M36x2	28	115	67	69	41	21.0

11C56 – Metric female swivel 24° with O-ring

90° elbow – Heavy series – Metric swivel nut – ISO 12151-2

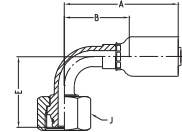

MATERIAL Galvanised steel with transparent Cr(IV)-free plating.
Other materials available on request.

Part No. #	DN size				Connection type		A mm	B mm	E mm	J mm	Max. WP MPa
	mm	inch	Thread size	Tube OD mm							
11C56-10-4	6	-04	6.4	1/4	M18x1.5	10	53	29	32	22	63.0
11C56-12-5	8	-05	7.9	5/16	M20x1.5	12	58	33	34	24	63.0
11C56-12-6	10	-06	9.5	3/8	M20x1.5	12	59	34	37	24	63.0
11C56-16-8	12	-08	12.7	1/2	M24x1.5	16	68	40	45	30	42.0

56 series

1D056 – Metric male 24°

Light series – ISO 12151-2

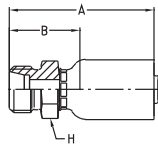

MATERIAL Galvanised steel with transparent Cr(IV)-free plating.
Other materials available on request.

Part No. #	DN size				Connection type		A mm	B mm	H mm	Max. WP MPa
	mm	inch	Thread size	Tube OD mm						
1D056-6-3	5	-03	4.8	3/16	M12x1.5	6	41	23	12	25.0
1D056-8-4	6	-04	6.4	1/4	M14x1.5	8	48	23	14	42.5
1D056-10-5	8	-05	7.9	5/16	M16x1.5	10	50	24	17	40.0
1D056-12-5	8	-05	7.9	5/16	M18x1.5	12	52	26	19	35.0
1D056-10-6	10	-06	9.5	3/8	M16x1.5	10	50	25	17	40.0
1D056-12-6	10	-06	9.5	3/8	M18x1.5	12	52	26	19	35.0
1D056-15-6	10	-06	9.5	3/8	M22x1.5	15	53	27	22	31.0
1D056-15-8	12	-08	12.7	1/2	M22x1.5	15	56	28	24	31.0
1D056-18-12	20	-12	19.0	3/4	M26x1.5	18	66	33	27	28.0
1D056-22-12	20	-12	19.0	3/4	M30x2	22	67	33	32	28.0
1D056-28-16	25	-16	25.4	1	M36x2	28	84	36	36	21.0

56 series

1D256 – Metric male 24°

Heavy series – ISO 12151-2

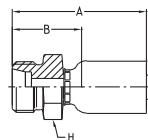

MATERIAL Galvanised steel with transparent Cr(IV)-free plating.
Other materials available on request.

Part No. #	DN size				Connection type		A mm	B mm	H mm	Max. WP MPa
	mm	inch	Thread size	Tube OD mm						
1D256-8-3	5	-03	4.8	3/16	M16x1.5	8	43	25	17	63.0
1D256-10-4	6	-04	6.4	1/4	M18x1.5	10	52	27	19	63.0
1D256-12-5	8	-05	7.9	5/16	M20x1.5	12	53	27	22	63.0
1D256-14-6	10	-06	9.5	3/8	M22x1.5	14	57	31	24	63.0
1D256-16-6	10	-06	9.5	3/8	M24x1.5	16	57	31	24	42.0
1D256-16-8	12	-08	12.7	1/2	M24x1.5	16	60	32	24	42.0
1D256-20-12	20	-12	19.0	3/4	M30x2	20	72	39	32	42.0

11D56 – Metric standpipe

Light series

MATERIAL Galvanised steel with transparent Cr(IV)-free plating.
Other materials available on request.

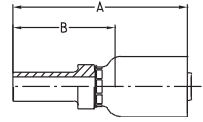

Part No. #	DN size				Tube OD mm	A mm	B mm	Max. WP MPa
	mm	inch	mm	inch				
11D56-6-3	5	-03	4.8	3/16	6	50	32	25.0
11D56-6-4	6	-04	6.4	1/4	6	57	32	25.0
11D56-8-4	6	-04	6.4	1/4	8	57	32	25.0
11D56-10-5	8	-05	7.9	5/16	10	60	34	25.0
11D56-10-6	10	-06	9.5	3/8	10	60	34	25.0
11D56-12-6	10	-06	9.5	3/8	12	61	35	25.0
11D56-15-8	12	-08	12.7	1/2	15	66	39	25.0
11D56-18-8	12	-08	12.7	1/2	18	68	41	16.0
11D56-18-12	20	-12	19.0	3/4	18	74	40	16.0
11D56-22-12	20	-12	19.0	3/4	22	76	42	16.0
11D56-28-16	25	-16	25.4	1	28	94	46	10.0

NOTE: Not recommended for new constructions. Please refer to end connections C3 or CA.

13D56 – Metric standpipe

Heavy series

MATERIAL Galvanised steel with transparent Cr(IV)-free plating.
Other materials available on request.

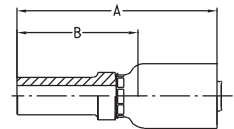

Part No. #	DN size				Tube OD mm	A mm	B mm	Max. WP MPa
	mm	inch	mm	inch				
13D56-8-3	5	-03	4.8	3/16	8	52	34	63.0
13D56-8-4	6	-04	6.4	1/4	8	59	34	63.0
13D56-10-4	6	-04	6.4	1/4	10	61	36	63.0
13D56-12-5	8	-05	7.9	5/16	12	63	37	63.0
13D56-12-6	10	-06	9.5	3/8	12	64	38	63.0
13D56-14-6	10	-06	9.5	3/8	14	67	41	63.0
13D56-16-8	12	-08	12.7	1/2	16	71	44	40.0
13D56-20-12	20	-12	19.0	3/4	20	84	50	40.0
13D56-25-12	20	-12	19.0	3/4	25	88	54	40.0

NOTE: Not recommended for new constructions. Please refer to end connections C9.

19256 – BSP female swivel 60° cone

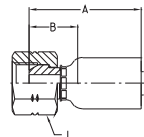

MATERIAL Galvanised steel with transparent Cr(IV)-free plating.
Other materials available on request.

Part No. #	DN size			Connection type Thread size	Tube OD inch	A mm	B mm	J mm	Max. WP MPa
	mm	inch	inch						
19256-4-3	5	-03	4.8	G 1/4	1/4	37	19	19	63.0
19256-2-4	6	-04	6.4	G 1/8	1/8	43	18	14	35.0
19256-4-4	6	-04	6.4	G 1/4	1/4	44	20	19	63.0
19256-6-4	6	-04	6.4	G 3/8	3/8	44	20	22	55.0
19256-4-5	8	-05	7.9	G 1/4	1/4	45	20	19	63.0
19256-6-5	8	-05	7.9	G 3/8	3/8	45	20	22	55.0
19256-6-6	10	-06	9.5	G 3/8	3/8	45	20	22	55.0
19256-8-6	10	-06	9.5	G 1/2	1/2	47	22	27	43.0
19256-8-8	12	-08	12.7	G 1/2	1/2	51	22	27	43.0
19256-10-8	12	-08	12.7	G 5/8	5/8	49	22	30	37.5
19256-12-12	20	-12	19.0	G 3/4	3/4	58	24	32	35.0
19256-16-16	25	-16	25.4	G 1	1	73	26	41	28.0

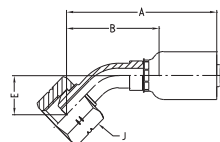
1B156 – BSP female swivel 60° cone
45° elbow

MATERIAL Galvanised steel with transparent Cr(IV)-free plating.
Other materials available on request.

Part No. #	DN size			Connection type Thread size	Tube OD inch	A mm	B mm	E mm	J mm	Max. WP MPa
	mm	inch	inch							
1B156-4-3	5	-03	4.8	G 1/4	1/4	54	36	14	19	63.0
1B156-4-4	6	-04	6.4	G 1/4	1/4	62	38	16	19	63.0
1B156-6-5	8	-05	7.9	G 3/8	3/8	64	39	16	22	55.0
1B156-6-6	10	-06	9.5	G 3/8	3/8	66	41	17	22	55.0
1B156-8-8	12	-08	12.7	G 1/2	1/2	76	48	20	27	43.0
1B156-10-8	12	-08	12.7	G 5/8	5/8	75	48	19	30	37.5
1B156-12-12	20	-12	19.0	G 3/4	3/4	99	65	25	32	35.0

1B256 – BSP female swivel 60° cone 90° elbow

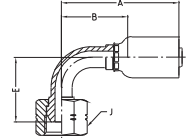

MATERIAL Galvanised steel with transparent Cr(IV)-free plating.
Other materials available on request.

Part No. #	DN size				Connection type		A mm	B mm	E mm	J mm	Max. WP MPa
	mm	inch	Thread size	Tube OD inch							
1B256-4-3	5	-03	4.8	3/16	G 1/4	1/4	46	28	28	19	63.0
1B256-4-4	6	-04	6.4	1/4	G 1/4	1/4	53	29	28	19	63.0
1B256-6-5	8	-05	7.9	5/16	G 3/8	3/8	55	30	30	22	55.0
1B256-6-6	10	-06	9.5	3/8	G 3/8	3/8	58	33	33	22	55.0
1B256-8-8	12	-08	12.7	1/2	G 1/2	1/2	68	40	40	27	43.0
1B256-10-8	12	-08	12.7	1/2	G 5/8	5/8	68	41	38	30	37.5
1B256-12-12	20	-12	19.0	3/4	G 3/4	3/4	87	53	51	32	35.0
1B256-16-16	25	-16	25.4	1	G 1	1	115	67	63	41	28.0

1B456 – BSP female swivel 60° cone 90° compact elbow

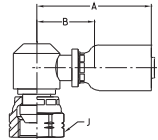

MATERIAL Galvanised steel with transparent Cr(IV)-free plating.
Other materials available on request.

Part No. #	DN size				Thread size	A mm	B mm	J mm	Max. WP MPa
	mm	inch							
1B456-4-4	6	-04	6.4	1/4	G 1/4	47	23	19	63.0
1B456-6-6	10	-06	9.5	3/8	G 3/8	52	27	22	55.0
1B456-8-8	12	-08	12.7	1/2	G 1/2	58	31	27	43.0

1D956 – BSP male

DIN 3852 Form A

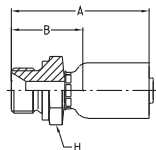

MATERIAL Galvanised steel with transparent Cr(IV)-free plating.
Other materials available on request.

Part No. #	DN size				Connection type		A mm	B mm	H mm	Max. WP MPa
	mm	inch	Thread size	Tube OD inch						
1D956-4-4	6	-04	6.4	1/4	G 1/4	1/4	52	27	19	63.0
1D956-6-5	8	-05	7.9	5/16	G 3/8	3/8	53	27	22	55.0
1D956-6-6	10	-06	9.5	3/8	G 3/8	3/8	53	28	22	55.0
1D956-8-8	12	-08	12.7	1/2	G 1/2	1/2	60	32	27	43.0
1D956-12-12	20	-12	19.0	3/4	G 3/4	3/4	75	42	32	35.0

10656 – SAE (JIC) 37° female swivel

UNF swivel nut

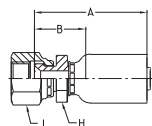

MATERIAL Galvanised steel with transparent Cr(IV)-free plating.
Other materials available on request.

Part No. #	DN size				Connection type		A mm	B mm	H mm	J mm	Max. WP MPa
	mm	inch	Thread size	Tube OD inch							
10656-4-3	5	-03	4.8	3/16	7/16 - 20UNF	1/4	36	19	12	17	41.0
10656-4-4	6	-04	6.4	1/4	7/16 - 20UNF	1/4	44	19	14	17	41.0
10656-5-4	6	-04	6.4	1/4	1/2 - 20UNF	5/16	44	20	14	17	41.0
10656-6-4	6	-04	6.4	1/4	9/16 - 18UNF	3/8	45	20	14	19	34.5
10656-6-5	8	-05	7.9	5/16	9/16 - 18UNF	3/8	47	21	17	19	34.5
10656-6-6	10	-06	9.5	3/8	9/16 - 18UNF	3/8	47	22	17	19	34.5
10656-8-6	10	-06	9.5	3/8	3/4 - 16UNF	1/2	49	24	19	22	34.5
10656-8-8	12	-08	12.7	1/2	3/4 - 16UNF	1/2	54	27	22	22	34.5

56 series

14956 – Banjo union

DIN 7642

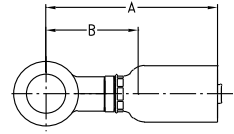

MATERIAL Galvanised steel with transparent Cr(IV)-free plating.
Other materials available on request.

Part No. #	DN size				Tube OD mm	A mm	B mm	Max. WP MPa
	mm	inch	mm	inch				
14956-14-3	5	-03	4.8	3/16	14	49	31	20.0
14956-10-4	6	-04	6.4	1/4	10	51	27	20.0
14956-12-4	6	-04	6.4	1/4	12	53	29	20.0
14956-14-4	6	-04	6.4	1/4	14	56	32	20.0
14956-12-5	8	-05	7.9	5/16	12	55	30	20.0
14956-14-5	8	-05	7.9	5/16	14	57	32	20.0
14956-12-6	10	-06	9.5	3/8	12	55	31	20.0

1EN56 – Universal Push to Connect

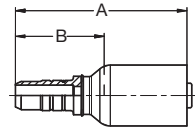

MATERIAL Galvanised steel with transparent Cr(IV)-free plating.
Other materials available on request.

Part No. #	DN size				Tube OD mm	A mm	B mm	Max. WP MPa
	mm	inch	mm	inch				
1EN56-6-3	5	-3	4.8	3/16	6	41	24	20
1EN56-8-4	6	-4	6.4	1/4	8	51	26	40
1EN56-10-4	6	-4	6.4	1/4	10	52	27	35
1EN56-10-5	8	-5	7.9	5/16	10	54	28	35
1EN56-12-6	10	-6	9.5	3/8	12	55	30	35
1EN56-15-8	12	-8	12.7	1/2	15	59	30	29.5
1EN56-18-10	16	-10	15.9	5/8	18	68	35	28
1EN56-22-12	20	-12	19.0	3/4	22	69	35	21.5

1ET56 – Universal Push to Connect 90° elbow

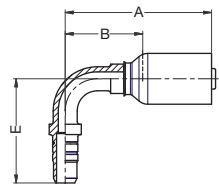

MATERIAL Galvanised steel with transparent Cr(IV)-free plating.
Other materials available on request.

Part No. #	DN	size	mm	inch	Tube OD mm	A mm	B mm	E mm	Max. WP MPa
1ET56-6-3	5	-3	4.8	3/16	6	46	28	36	20
1ET56-8-4	6	-4	6.4	1/4	8	53	28	38	40
1ET56-10-4	6	-4	6.4	1/4	10	53	28	38	35
1ET56-10-5	8	-5	7.9	5/16	10	55	29	39	35
1ET56-12-6	10	-6	9.5	3/8	12	58	32	40	35
1ET56-15-8	12	-8	12.7	1/2	15	68	39	45	29.5
1ET56-18-10	16	-10	15.9	5/8	18	74	41	54	28
1ET56-22-12	20	-12	19.0	3/4	22	92	58	60	21.5

56 series

1EU56 – Universal Push to Connect 45° elbow

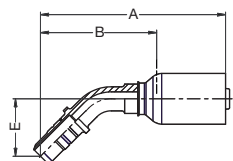

MATERIAL Galvanised steel with transparent Cr(IV)-free plating.
Other materials available on request.

Part No. #	DN	size	mm	inch	Tube OD mm	A mm	B mm	E mm	Max. WP MPa
1EU56-6-3	5	-3	4.8	3/16	6	60	42	21	20
1EU56-8-4	6	-4	6.4	1/4	8	68	44	22	40
1EU56-10-4	6	-4	6.4	1/4	10	67	43	21	35
1EU56-10-5	8	-5	7.9	5/16	10	69	44	22	35
1EU56-12-6	10	-6	9.5	3/8	12	72	47	23	35
1EU56-15-8	12	-8	12.7	1/2	15	78	49	24	29.5
1EU56-18-10	16	-10	15.9	5/8	18	92	58	29	28
1EU56-22-12	20	-12	19.0	3/4	22	104	70	30	21.5



10157 - National Pipe Tapered (NPT) male

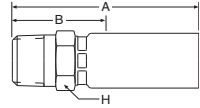

MATERIAL Galvanised steel with transparent Cr(IV)-free plating.
Other materials available on request.

Part No. #	DN size				Connection type		A mm	B mm	H mm	Max. WP MPa
	mm	inch	Thread size	Tube OD inch						
10157-2-2	3	-02	3.2	1/8	1/8 - 27NPTF	1/8	35	18.0	13	34.5

10657 - SAE (JIC) 37° female swivel UNF swivel nut

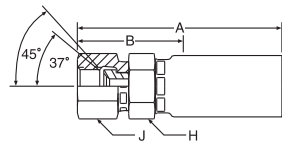

MATERIAL Galvanised steel with transparent Cr(IV)-free plating.
Other materials available on request.

Part No. #	DN size				Connection type		A mm	B mm	H mm	J mm	Max. WP MPa
	mm	inch	Thread size	Tube OD inch							
10657-4-2	3	-02	3.2	1/8	7/16 - 20UNF	1/4	33	16.0	13	17	41.0

1C658 – Metric female swivel 24°/60°

Heavy series – Metric swivel nut

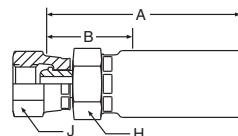

MATERIAL Galvanised steel with transparent Cr(IV)-free plating.
Other materials available on request.

Part No. #	DN	size		Connection type		Tube OD mm	A mm	B mm	H mm	J mm	Max. WP MPa
		mm	inch	Thread size	Thread size						
1C658-8-3	5	-03	4.8	3/16	M16x1.5	8	53	28	17	19	63.0
1C658-10-4	6	-04	6.4	1/4	M18x1.5	10	60	28	19	22	63.0
1C658-12-5	8	-05	7.9	5/16	M20x1.5	12	64	32	22	24	63.0
1C658-12-6	10	-06	9.5	3/8	M20x1.5	12	69	32	22	24	63.0
1C658-14-6	10	-06	9.5	3/8	M22x1.5	14	66	30	24	27	63.0
1C658-14-8	12	-08	12.7	1/2	M22x1.5	14	71	30	24	27	63.0
1C658-16-8	12	-08	12.7	1/2	M24x1.5	16	72	31	27	30	40.0
1C658-20-12	20	-12	19.0	3/4	M30x2	20	84	38	32	36	40.0
1C658-25-12	20	-12	19.0	3/4	M36x2	25	82	36	36	46	40.0
1C658-30-16	25	-16	25.4	1	M42x2	30	102	42	38	50	25.0

58 series

1CA58 – Metric female swivel 24° with O-ring

Light series – Metric swivel nut – ISO 12151-2

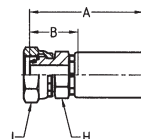

MATERIAL Galvanised steel with transparent Cr(IV)-free plating.
Other materials available on request.

Part No. #	DN	size		Connection type		Tube OD mm	A mm	B mm	H mm	J mm	Max. WP MPa
		mm	inch	Thread size	Thread size						
1CA58-6-3	5	-03	4.8	3/16	M12x1.5	6	54	29	14	14	31.5
1CA58-8-4	6	-04	6.4	1/4	M14x1.5	8	60	29	17	19	42.5
1CA58-10-5	8	-05	7.9	5/16	M16x1.5	10	62	30	19	19	40.0
1CA58-12-5	8	-05	7.9	5/16	M18x1.5	12	63	31	19	22	35.0
1CA58-10-6	10	-06	9.5	3/8	M16x1.5	10	67	31	19	19	40.0
1CA58-12-6	10	-06	9.5	3/8	M18x1.5	12	68	31	19	22	35.0
1CA58-15-8	12	-08	12.7	1/2	M22x1.5	15	74	33	24	27	31.5
1CA58-18-10	16	-10	15.9	5/8	M26x1.5	18	80	35	27	32	31.5
1CA58-18-12	20	-12	19.0	3/4	M26x1.5	18	80	34	32	32	31.5
1CA58-22-12	20	-12	19.0	3/4	M30x2	22	80	34	32	36	28.0
1CA58-28-16	25	-16	25.4	1	M36x2	28	101	41	36	46	21.0

1C958 – Metric female swivel 24° with O-ring

Heavy series – Metric swivel nut – ISO 12151-2

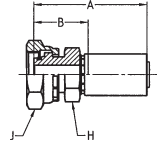

MATERIAL Galvanised steel with transparent Cr(IV)-free plating.
Other materials available on request.

Part No. #	DN size				Connection type		A mm	B mm	H mm	J mm	Max. WP MPa
	mm	inch	Thread size	Tube OD mm							
1C958-8-3	5	-03	4.8	3/16	M16x1.5	8	54	29	17	19	63.0
1C958-10-4	6	-04	6.4	1/4	M18x1.5	10	67	36	17	22	63.0
1C958-12-5	8	-05	7.9	5/16	M20x1.5	12	63	32	19	24	63.0
1C958-12-6	10	-06	9.5	3/8	M20x1.5	12	68	32	19	24	63.0
1C958-14-6	10	-06	9.5	3/8	M22x1.5	14	70	33	24	27	63.0
1C958-16-8	12	-08	12.7	1/2	M24x1.5	16	77	36	24	30	42.0
1C958-20-10	16	-10	15.9	5/8	M30x2	20	83	38	30	36	42.0
1C958-20-12	20	-12	19.0	3/4	M30x2	20	84	38	30	36	42.0
1C958-25-12	20	-12	19.0	3/4	M36x2	25	88	42	36	46	42.0
1C958-30-16	25	-16	25.4	1	M42x2	30	104	44	41	50	42.0

1CE58 – Metric female swivel 24° with O-ring

45° elbow – Light series – Metric swivel nut – ISO 12151-2

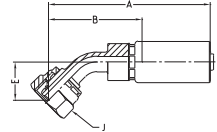

MATERIAL Galvanised steel with transparent Cr(IV)-free plating.
Other materials available on request.

Part No. #	DN size				Connection type		A mm	B mm	E mm	J mm	Max. WP MPa
	mm	inch	Thread size	Tube OD mm							
1CE58-6-3	5	-03	4.8	3/16	M12x1.5	6	67	42	16	14	31.5
1CE58-8-4	6	-04	6.4	1/4	M14x1.5	8	75	43	18	19	42.5
1CE58-10-5	8	-05	7.9	5/16	M16x1.5	10	75	44	18	19	40.0
1CE58-10-6	10	-06	9.5	3/8	M16x1.5	10	83	46	19	19	40.0
1CE58-12-6	10	-06	9.5	3/8	M18x1.5	12	83	46	19	22	35.0
1CE58-15-8	12	-08	12.7	1/2	M22x1.5	15	92	51	21	27	31.5
1CE58-18-10	16	-10	15.9	5/8	M26x1.5	18	101	56	23	32	31.5
1CE58-18-12	20	-12	19.0	3/4	M26x1.5	18	108	62	25	32	31.5
1CE58-22-12	20	-12	19.0	3/4	M30x2	22	108	62	26	36	28.0

10C58 – Metric female swivel 24° with O-ring

45° elbow – Heavy series – Metric swivel nut – ISO 12151-2

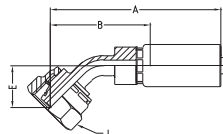

MATERIAL Galvanised steel with transparent Cr(IV)-free plating.
Other materials available on request.

Part No. #	DN size			Connection type Thread size	Tube OD mm	A mm	B mm	E mm	J mm	Max. WP MPa
	mm	inch	inch							
10C58-8-3	5	-03	4.8	M16x1.5	8	68	43	18	19	63.0
10C58-16-8	12	-08	12.7	M24x1.5	16	93	52	23	30	42.0

1CF58 – Metric female swivel 24° with O-ring

90° elbow – Light series – Metric swivel nut – ISO 12151-2

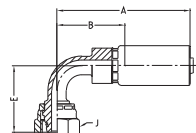

MATERIAL Galvanised steel with transparent Cr(IV)-free plating.
Other materials available on request.

Part No. #	DN size			Connection type Thread size	Tube OD mm	A mm	B mm	E mm	J mm	Max. WP MPa
	mm	inch	inch							
1CF58-6-3	5	-03	4.8	M12x1.5	6	55	30	29	14	31.5
1CF58-8-4	6	-04	6.4	M14x1.5	8	64	32	32	19	42.5
1CF58-10-5	8	-05	7.9	M16x1.5	10	65	33	32	19	40.0
1CF58-10-6	10	-06	9.5	M16x1.5	10	73	36	35	19	40.0
1CF58-12-6	10	-06	9.5	M18x1.5	12	73	36	35	22	35.0
1CF58-15-8	12	-08	12.7	M22x1.5	15	82	41	42	27	31.5
1CF58-18-10	16	-10	15.9	M26x1.5	18	91	46	46	32	31.5
1CF58-18-12	20	-12	19.0	M26x1.5	18	100	54	54	32	31.5
1CF58-22-12	20	-12	19.0	M30x2	22	100	54	52	36	28.0
1CF58-28-16	25	-16	25.4	M36x2	28	122	62	65	46	21.0



11C58 – Metric female swivel 24° with O-ring

90° elbow – Heavy series – Metric swivel nut – ISO 12151-2

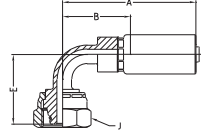

MATERIAL Galvanised steel with transparent Cr(IV)-free plating.
Other materials available on request.

Part No. #	DN size				Connection type		A mm	B mm	E mm	J mm	Max. WP MPa
	mm	inch	Thread size	Tube OD mm							
11C58-12-5	8	-05	7.9	5/16	M20x1.5	12	65	33	34	24	63.0
11C58-12-6	10	-06	9.5	3/8	M20x1.5	12	73	36	37	24	63.0
11C58-16-8	12	-08	12.7	1/2	M24x1.5	16	82	41	44	30	42.0

1D058 – Metric male 24°

Light series – ISO 12151-2

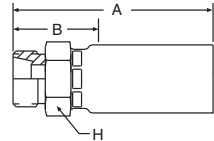

MATERIAL Galvanised steel with transparent Cr(IV)-free plating.
Other materials available on request.

Part No. #	DN size				Connection type		A mm	B mm	H mm	Max. WP MPa
	mm	inch	Thread size	Tube OD mm						
1D058-6-3	5	-03	4.8	3/16	M12x1.5	6	49	23	17	25.0
1D058-8-4	6	-04	6.4	1/4	M14x1.5	8	55	23	19	42.5
1D058-10-5	8	-05	7.9	5/16	M16x1.5	10	58	26	19	40.0
1D058-12-5	8	-05	7.9	5/16	M18x1.5	12	59	27	19	35.0
1D058-10-6	10	-06	9.5	3/8	M16x1.5	10	63	26	22	40.0
1D058-12-6	10	-06	9.5	3/8	M18x1.5	12	64	27	22	35.0
1D058-15-6	10	-06	9.5	3/8	M22x1.5	15	67	30	27	31.0
1D058-15-8	12	-08	12.7	1/2	M22x1.5	15	71	30	27	31.0
1D058-18-12	20	-12	19.0	3/4	M26x1.5	18	76	30	32	28.0
1D058-22-12	20	-12	19.0	3/4	M30x2	22	77	31	36	28.0
1D058-28-16	25	-16	25.4	1	M36x2	28	91	31	41	21.0

1D258 – Metric male 24°

Heavy series – ISO 12151-2

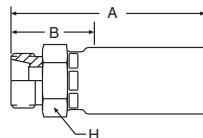

MATERIAL Galvanised steel with transparent Cr(IV)-free plating.
Other materials available on request.

Part No. #	DN size				Connection type		A mm	B mm	H mm	Max. WP MPa
	mm	inch	Thread size	Tube OD mm						
1D258-8-3	5	-03	4.8	3/16	M16x1.5	8	52	27	19	63.0
1D258-10-4	6	-04	6.4	1/4	M18x1.5	10	58	26	22	63.0
1D258-12-5	8	-05	7.9	5/16	M20x1.5	12	62	30	24	63.0
1D258-14-6	10	-06	9.5	3/8	M22x1.5	14	69	32	27	63.0
1D258-16-8	12	-08	12.7	1/2	M24x1.5	16	73	32	27	42.0
1D258-20-12	20	-12	19.0	3/4	M30x2	20	79	33	36	42.0
1D258-25-12	20	-12	19.0	3/4	M36x2	25	81	35	41	42.0
1D258-30-16	25	-16	25.4	1	M42x2	30	95	35	46	42.0

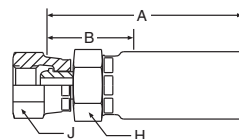
19258 – BSP female swivel 60° cone

MATERIAL Galvanised steel with transparent Cr(IV)-free plating.
Other materials available on request.

Part No. #	DN size				Connection type		A mm	B mm	H mm	J mm	Max. WP MPa
	mm	inch	Thread size	Tube OD inch							
19258-4-3	5	-03	4.8	3/16	G 1/4	1/4	53	28	17	19	63.0
19258-4-4	6	-04	6.4	1/4	G 1/4	1/4	58	26	17	19	63.0
19258-6-5	8	-05	7.9	5/16	G 3/8	3/8	59	27	19	22	55.0
19258-6-6	10	-06	9.5	3/8	G 3/8	3/8	64	27	19	22	55.0
19258-8-8	12	-08	12.7	1/2	G 1/2	1/2	72	31	24	27	43.0
19258-10-8	12	-08	12.7	1/2	G 5/8	5/8	75	34	27	30	37.5
19258-12-12	20	-12	19.0	3/4	G 3/4	3/4	81	35	32	32	35.0
19258-16-16	25	-16	25.4	1	G 1	1	99	39	36	41	28.0



1B258 – BSP female swivel 60° cone 90° elbow

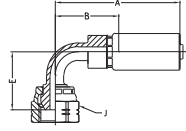

MATERIAL Galvanised steel with transparent Cr(IV)-free plating.
Other materials available on request.

Part No. #	DN size				Connection type		A mm	B mm	E mm	J mm	Max. WP MPa
	mm	inch	Thread size	Tube OD inch							
1B258-4-4	6	-04	6.4	1/4	G 1/4	1/4	64	32	28	19	63.0
1B258-6-5	8	-05	7.9	5/16	G 3/8	3/8	65	33	30	22	55.0
1B258-6-6	10	-06	9.5	3/8	G 3/8	3/8	73	36	33	22	55.0
1B258-8-8	12	-08	12.7	1/2	G 1/2	1/2	82	41	40	27	43.0
1B258-10-8	12	-08	12.7	1/2	G 5/8	5/8	82	41	38	30	37.5
1B258-12-12	20	-12	19.0	3/4	G 3/4	3/4	100	54	53	32	35.0
1B258-16-16	25	-16	25.4	1	G 1	1	127	67	65	41	28.0

1D958 – BSP male DIN 3852 Form A

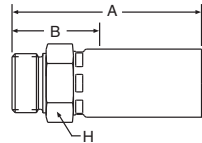

MATERIAL Galvanised steel with transparent Cr(IV)-free plating.
Other materials available on request.

Part No. #	DN size				Connection type		A mm	B mm	H mm	Max. WP MPa
	mm	inch	Thread size	Tube OD inch						
1D958-4-4	6	-04	6.4	1/4	G 1/4	1/4	58	26	19	63.0
1D958-6-5	8	-05	7.9	5/16	G 3/8	3/8	59	27	22	55.0
1D958-6-6	10	-06	9.5	3/8	G 3/8	3/8	64	27	22	55.0
1D958-8-8	12	-08	12.7	1/2	G 1/2	1/2	72	31	27	43.0
1D958-12-12	20	-12	19.0	3/4	G 3/4	3/4	80	34	32	35.0
1D958-16-16	25	-16	25.4	1	G 1	1	95	35	41	28.0

10158 – National Pipe Tapered (NPT) male

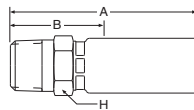

MATERIAL Galvanised steel with transparent Cr(IV)-free plating.
Other materials available on request.

Part No. #	DN size			mm		inch		Connection type		A mm	B mm	H mm	Max. WP MPa
	Thread size	Tube OD inch	mm	inch	mm	inch	mm	inch					
10158-2-3	5	-03	4.8	3/16	1/8 - 27NPTF	1/8	51	26	14	34.5			
10158-4-3	5	-03	4.8	3/16	1/4 - 18NPTF	1/4	55	30	17	34.5			
10158-6-3	5	-03	4.8	3/16	3/8 - 18NPTF	3/8	54	29	19	27.5			
10158-2-4	6	-04	6.4	1/4	1/8 - 27NPTF	1/8	54	22	17	34.5			
10158-4-4	6	-04	6.4	1/4	1/4 - 18NPTF	1/4	62	30	17	34.5			
10158-6-4	6	-04	6.4	1/4	3/8 - 18NPTF	3/8	61	29	19	27.5			
10158-4-5	8	-05	7.9	5/16	1/4 - 18NPTF	1/4	59	27	17	34.5			
10158-6-5	8	-05	7.9	5/16	3/8 - 18NPTF	3/8	61	29	19	27.5			
10158-4-6	10	-06	9.5	3/8	1/4 - 18NPTF	1/4	66	30	19	34.5			
10158-6-6	10	-06	9.5	3/8	3/8 - 18NPTF	3/8	70	33	19	27.5			
10158-8-6	10	-06	9.5	3/8	1/2 - 14NPTF	1/2	77	40	27	24.0			
10158-6-8	12	-08	12.7	1/2	3/8 - 18NPTF	3/8	71	30	22	27.5			
10158-8-8	12	-08	12.7	1/2	1/2 - 14NPTF	1/2	77	36	27	24.0			
10158-12-12	20	-12	19.0	3/4	3/4 - 14NPTF	3/4	82	36	30	21.0			
10158-16-16	25	-16	25.4	1	1 - 11 1/2NPTF	1	104	44	41	17.0			



10658 – SAE (JIC) 37° female swivel UNF swivel nut

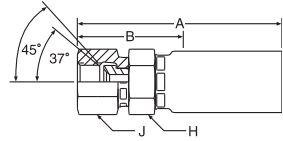

MATERIAL Galvanised steel with transparent Cr(IV)-free plating.
For stainless steel (AISI 316) please add **C** to the Part No. Example: 10658-4-3C.
Other materials available on request.

Part No. #	DN size			mm		inch		Connection type		A mm	B mm	H mm	J mm	Max. WP MPa
	5	-03	4.8	3/16	Thread size	Tube OD inch	Thread icon	Tube icon						
10658-4-3	5	-03	4.8	3/16	7/16 - 20UNF	1/4	55	30	16	17	41.0			
10658-5-3	5	-03	4.8	3/16	1/2 - 20UNF	5/16	57	32	16	17	41.0			
10658-4-4	6	-04	6.4	1/4	7/16 - 20UNF	1/4	65	33	17	17	41.0			
10658-5-4	6	-04	6.4	1/4	1/2 - 20UNF	5/16	65	33	16	17	41.0			
10658-6-4	6	-04	6.4	1/4	9/16 - 18UNF	3/8	67	35	17	19	34.5			
10658-5-5	8	-05	7.9	5/16	1/2 - 20UNF	5/16	65	33	16	17	41.0			
10658-6-5	8	-05	7.9	5/16	9/16 - 18UNF	3/8	65	33	16	19	34.5			
10658-6-6	10	-06	9.5	3/8	9/16 - 18UNF	3/8	69	33	19	19	34.5			
10658-8-6	10	-06	9.5	3/8	3/4 - 16UNF	1/2	72	35	19	24	34.5			
10658-6-8	12	-08	12.7	1/2	9/16 - 18UNF	3/8	76	35	22	19	34.5			
10658-8-8	12	-08	12.7	1/2	3/4 - 16UNF	1/2	79	38	22	22	34.5			
10658-10-8	12	-08	12.7	1/2	7/8 - 14UNF	5/8	82	41	22	27	34.5			
10658-12-8	12	-08	12.7	1/2	1 1/16 - 12UNF	3/4	83	42	27	32	34.5			
10658-12-12	20	-12	19.0	3/4	1 1/16 - 12UNF	3/4	88	42	30	32	34.5			
10658-16-12	20	-12	19.0	3/4	1 5/16 - 12UNF	1	90	44	36	38	27.5			
10658-16-16	25	-16	25.4	1	1 5/16 - 12UNF	1	104	44	36	38	27.5			

58 series

13958 – SAE (JIC) 37° female swivel 90° elbow – UNF swivel nut

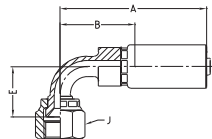

MATERIAL Galvanised steel with transparent Cr(IV)-free plating.
Other materials available on request.

Part No. #	DN size			Connection type		Tube OD inch	A mm	B mm	E mm	J mm	Max. WP MPa
	mm	inch	Thread size	Thread size							
13958-4-3-SM	5	-03	4.8	3/16	7/16 - 20UNF	1/4	55	30	21	17	41.0
13958-4-4-SM	6	-04	6.4	1/4	7/16 - 20UNF	1/4	64	32	21	17	41.0
13958-5-4-SM	6	-04	6.4	1/4	1/2 - 20UNF	5/16	64	32	25	17	41.0
13958-6-4-SM	6	-04	6.4	1/4	9/16 - 18UNF	3/8	64	32	22	19	34.5
13958-6-5-SM	8	-05	7.9	5/16	9/16 - 18UNF	3/8	65	33	22	19	34.5
13958-6-6-SM	10	-06	9.5	3/8	9/16 - 18UNF	3/8	73	36	28	19	34.5
13958-8-6-SM	10	-06	9.5	3/8	3/4 - 16UNF	1/2	71	34	29	22	34.5
13958-8-8-SM	12	-08	12.7	1/2	3/4 - 16UNF	1/2	77	36	29	22	34.5
13958-10-8-SM	12	-08	12.7	1/2	7/8 - 14UNF	5/8	77	36	32	27	34.5
13958-12-12-SM	20	-12	19.0	3/4	1 1/16 - 12UNF	3/4	97	51	46	32	34.5
13958-16-16-SM	25	-16	25.4	1	1 5/16 - 12UNF	1	121	61	55	41	27.5

58 series

1JC58 – O-Lok® ORFS swivel nut Short version – UNF swivel nut – ISO 12151-1

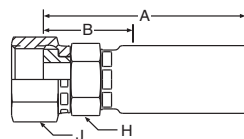

MATERIAL Galvanised steel with transparent Cr(IV)-free plating.
Other materials available on request.

Part No. #	DN size			Connection type		Tube OD inch	A mm	B mm	H mm	J mm	Max. WP MPa
	mm	inch	Thread size	Thread size							
1JC58-4-3-SM	5	-03	4.8	3/16	9/16 - 18UNF	1/4	47	22	17	17	41.0
1JC58-4-4-SM	6	-04	6.4	1/4	9/16 - 18UNF	1/4	53	22	17	17	41.0
1JC58-6-4-SM	6	-04	6.4	1/4	11/16 - 16UNF	3/8	59	27	19	22	41.0
1JC58-4-5-SM	8	-05	7.9	5/16	9/16 - 18UNF	1/4	53	22	17	17	41.0
1JC58-6-5-SM	8	-05	7.9	5/16	11/16 - 16UNF	3/8	56	25	19	22	41.0
1JC58-6-6-SM	10	-06	9.5	3/8	11/16 - 16UNF	3/8	61	25	19	22	41.0
1JC58-8-6-SM	10	-06	9.5	3/8	13/16 - 16UNF	1/2	63	27	22	24	41.0
1JC58-8-8-SM	12	-08	12.7	1/2	13/16 - 16UNF	1/2	69	27	24	24	41.0
1JC58-10-8-SM	12	-08	12.7	1/2	1 - 14UNF	5/8	73	32	30	30	41.0
1JC58-12-12-SM	20	-12	19.0	3/4	1 3/16 - 12UNF	3/4	79	33	32	36	41.0
1JC58-16-16-SM	25	-16	25.4	1	1 7/16 - 12UNF	1	96	36	36	41	41.0

1JS58 – O-Lok® ORFS swivel nut

Long version – UNF swivel nut – ISO 12151-1

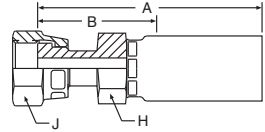

MATERIAL Galvanised steel with transparent Cr(IV)-free plating.
Other materials available on request.

Part No. #	DN size			Thread size	Connection type						
	mm	inch			Tube OD inch	A mm	B mm	H mm	J mm	Max. WP MPa	
1JS58-4-3-SM	5	-03	4.8	3/16	9/16 - 18UNF	1/4	60	35	17	17	41.0
1JS58-4-4-SM	6	-04	6.4	1/4	9/16 - 18UNF	1/4	67	35	17	17	41.0
1JS58-6-4-SM	6	-04	6.4	1/4	11/16 - 16UNF	3/8	66	35	19	22	41.0
1JS58-4-5-SM	8	-05	7.9	5/16	9/16 - 18UNF	1/4	67	35	17	17	41.0
1JS58-6-5-SM	8	-05	7.9	5/16	11/16 - 16UNF	3/8	66	35	19	22	41.0
1JS58-6-6-SM	10	-06	9.5	3/8	11/16 - 16UNF	3/8	71	35	19	22	41.0
1JS58-8-6-SM	10	-06	9.5	3/8	13/16 - 16UNF	1/2	75	38	22	24	41.0
1JS58-8-8-SM	12	-08	12.7	1/2	13/16 - 16UNF	1/2	80	38	22	24	41.0
1JS58-10-10-SM	16	-10	15.9	5/8	1 - 14UNF	5/8	90	44	30	30	41.0
1JS58-12-12-SM	20	-12	19.0	3/4	1 3/16 - 12UNF	3/4	94	48	32	36	41.0
1JS58-16-16-SM	25	-16	25.4	1	1 7/16 - 12UNF	1	112	52	36	41	41.0

1J758 – O-Lok® ORFS swivel nut

45° elbow – UNF swivel nut – ISO 12151-1

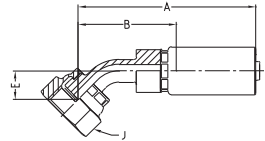

MATERIAL Galvanised steel with transparent Cr(IV)-free plating.
Other materials available on request.

Part No. #	DN size			Thread size	Connection type						
	mm	inch			Tube OD inch	A mm	B mm	E mm	J mm	Max. WP MPa	
1J758-4-4	6	-04	6.4	1/4	9/16 - 18UNF	5/16	71	39	10	17	41.0
1J758-6-4	6	-04	6.4	1/4	11/16 - 16UNF	3/8	73	41	12	22	41.0
1J758-6-6	10	-06	9.5	3/8	11/16 - 16UNF	3/8	78	41	14	22	41.0
1J758-8-6	10	-06	9.5	3/8	13/16 - 16UNF	1/2	78	42	14	24	41.0
1J758-8-8	12	-08	12.7	1/2	13/16 - 16UNF	1/2	83	42	12	24	41.0
1J758-12-12	20	-12	19.0	3/4	1 3/16 - 12UNF	3/4	103	57	21	36	41.0
1J758-16-16	25	-16	25.4	1	1 7/16 - 12UNF	1	130	70	26	41	41.0

1J958 – O-Lok® ORFS swivel nut

90° elbow – UNF swivel nut – ISO 12151-1

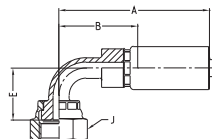

MATERIAL Galvanised steel with transparent Cr(IV)-free plating.
Other materials available on request.

Part No. #	DN size				Connection type		A mm	B mm	E mm	J mm	Max. WP MPa
	mm	inch	Thread size	Tube OD inch							
1J958-4-4	6	-04	6.4	1/4	9/16 - 18UNF	5/16	67	35	21	17	41.0
1J958-6-4	6	-04	6.4	1/4	11/16 - 16UNF	3/8	68	36	23	22	41.0
1J958-6-5	8	-05	7.9	5/16	11/16 - 16UNF	3/8	67	35	23	22	41.0
1J958-6-6	10	-06	9.5	3/8	11/16 - 16UNF	3/8	72	36	29	22	41.0
1J958-8-8	12	-08	12.7	1/2	13/16 - 16UNF	1/2	82	41	29	24	41.0
1J958-12-12	20	-12	19.0	3/4	1 3/16 - 12UNF	3/4	100	54	47	36	41.0
1J958-16-16	25	-16	25.4	1	1 7/16 - 12UNF	1	128	68	64	41	41.0



1C39X – Metric female swivel 24°/60° Light series – Metric swivel nut

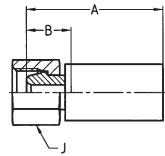

MATERIAL Galvanised steel with transparent Cr(IV)-free plating.
Other materials available on request.

Part No. #	DN size				Connection type		A mm	B mm	J mm	Max. WP MPa
	mm	inch	Thread size	Tube OD mm						
1C39X-12-06	10	-06	9.5	3/8	M18x1.5	12	48	19	22	25.0
1C39X-15-08	12	-08	12.7	1/2	M22x1.5	15	51	20	27	25.0

1C99X – Metric female swivel 24° with O-ring Heavy series – Metric swivel nut – ISO 12151-2

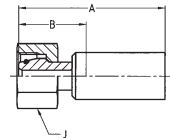

MATERIAL Galvanised steel with transparent Cr(IV)-free plating.
Other materials available on request.

Part No. #	DN size				Connection type		A mm	B mm	J mm	Max. WP MPa
	mm	inch	Thread size	Tube OD mm						
1C99X-12-06	10	-06	9.5	3/8	M20x1.5	12	63	29	24	63.0
1C99X-14-06	10	-06	9.5	3/8	M22x1.5	14	71	30	27	63.0
1C99X-16-08	12	-08	12.7	1/2	M24x1.5	16	78	35	30	42.0

10C9X – Metric female swivel 24° with O-ring

45° elbow – Heavy series – Metric swivel nut – ISO 12151-2

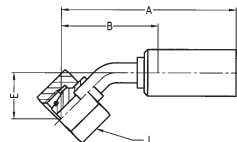

MATERIAL Galvanised steel with transparent Cr(IV)-free plating.
Other materials available on request.

Part No. #	DN size				Connection type		A mm	B mm	E mm	J mm	Max. WP MPa
	mm	inch	Thread size	Tube OD mm							
10C9X-14-06	10	-06	9.5	3/8	M22x1.5	14	81	40	19	27	63.0
10C9X-16-08	12	-08	12.7	1/2	M24x1.5	16	96	53	23	30	42.0

11C9X – Metric female swivel 24° with O-ring

90° elbow – Heavy series – Metric swivel nut – ISO 12151-2

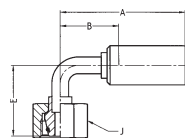

MATERIAL Galvanised steel with transparent Cr(IV)-free plating.
Other materials available on request.

Part No. #	DN size				Connection type		A mm	B mm	E mm	J mm	Max. WP MPa
	mm	inch	Thread size	Tube OD mm							
11C9X-14-06	10	-06	9.5	3/8	M22x1.5	14	71	30	36	27	63.0
11C9X-16-08	12	-08	12.7	1/2	M24x1.5	16	85	42	44	30	42.0



1D29X – Metric male 24°

Heavy series – ISO 12151-2

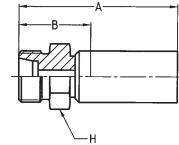

MATERIAL Galvanised steel with transparent Cr(IV)-free plating.
Other materials available on request.

Part No. #	DN size				Connection type		A mm	B mm	H mm	Max. WP MPa
	mm	inch	Thread size	Tube OD mm						
1D29X-14-06	10	-06	9.5	3/8	M22x1.5	14	71	31	22	63.0
1D29X-16-08	12	-08	12.7	1/2	M24x1.5	16	74	31	24	42.0

1929X – BSP female swivel 60° cone

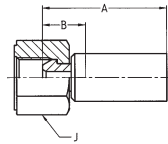

MATERIAL Galvanised steel with transparent Cr(IV)-free plating.
Other materials available on request.

Part No. #	DN size				Connection type		A mm	B mm	J mm	Max. WP MPa
	mm	inch	Thread size	Tube OD mm						
1929X-6-06	10	-06	9.5	3/8	G 3/8	59	19	22	55.0	
1929X-8-06	10	-06	9.5	3/8	G 1/2	60	20	27	43.0	
1929X-8-08	12	-08	12.7	1/2	G 1/2	63	20	27	43.0	



1069X – SAE (JIC) 37° female swivel UNF swivel nut

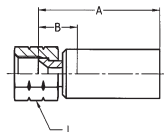

MATERIAL Galvanised steel with transparent Cr(IV)-free plating.
Other materials available on request.



Part No. #	DN size				Connection type	A	B	J	Max. WP MPa
	mm	inch	mm	inch	Thread size	mm	mm	mm	
1069X-6-06	10	-06	9.5	3/8	9/16 - 18UNF	59	18	22	34.5
1069X-8-06	10	-06	9.5	3/8	3/4 - 16UNF	59	19	24	34.5
1069X-10-08	12	-08	12.7	1/2	7/8 - 14UNF	62	19	27	34.5

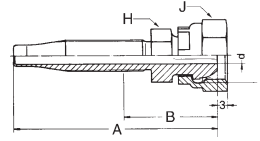

C3AB – Metric female swivel 24°/60° Light series



MATERIAL Galvanised steel with transparent Cr(IV)-free plating.
Other materials available on request.

Part No. #	DN size				Diameter d	Thread size 	A mm	B mm	H mm	J mm	Max. WP MPa 
	mm	inch	mm	inch							
C3AB-6-025	4	-025	4.0	5/32	4.0	M12x1.5	43	25	10	17	25.0
C3AB-8-04	6	-04	6.4	1/4	5.2	M14x1.5	59	27	12	17	25.0
C3AB-12-06	10	-06	9.7	3/8	8.8	M18x1.5	70	33	17	22	25.0

1DAB – Metric standpipe Light series

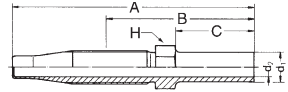

MATERIAL Galvanised steel with transparent Cr(IV)-free plating.
Other materials available on request.



Part No. #	DN size				Diameter		A mm	B mm	C mm	H mm	Max. WP MPa 
	mm	inch	d1	d2							
1DAB-6-025	4	-025	4.0	5/32	6.0	4.0	50	33	20	10	25.0
1DAB-8-04	6	-04	6.4	1/4	8.0	5.2	68	37	22	11	25.0
1DAB-10-05	8	-05	8.0	5/16	10.0	6.8	72	43	24	12	25.0
1DAB-12-06	10	-06	9.7	3/8	12.0	8.8	80	44	25	14	25.0
1DAB-15-06	10	-06	9.7	3/8	15.0	8.8	80	44	25	17	25.0

3DAB – Metric standpipe

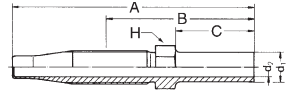
Heavy series





MATERIAL Galvanised steel with transparent Cr(IV)-free plating.
Other materials available on request.

Part No. #	DN size mm inch				Diameter d1 d2		A mm	B mm	C mm	H mm	Max. WP MPa
											
3DAB-8-025	4	-025	4.0	5/32	8.0	4.0	52	35	22	10	63.0
3DAB-10-04	6	-04	6.4	1/4	10.0	5.2	70	39	24	12	63.0

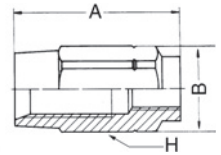
200AF – Reusable socket



MATERIAL Galvanised steel with transparent Cr(IV)-free plating.
Other materials available on request.

Part No. #	DN size mm inch				A mm	B mm	H mm
							
200AF-025	4	-025	4.0	5/32	25.0	13.3	12
200AF-04	6	-04	6.4	1/4	36.0	18.8	17
200AF-05	8	-05	8.0	5/16	38.0	20.9	19
200AF-06	10	-06	9.7	3/8	44.5	24.0	22



1CAEX – Metric female swivel 24° with O-ring

Light series – Metric swivel nut – ISO 12151-2

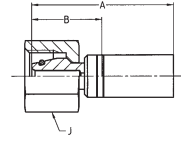

MATERIAL Galvanised steel with transparent Cr(IV)-free plating.
Other materials available on request.

Part No. #	DN size				Connection type						
	mm	inch	Thread size	Tube OD mm	A mm	B mm	J mm	Max. WP MPa			
1CAEX-6-012	2	-012	2.0	5/64	M12x1.5	6	32	21	14	31.5	
1CAEX-8-012	2	-012	2.0	5/64	M14x1.5	8	37	26	17	42.5	
1CAEX-6-025	4	-025	4.0	5/32	M12x1.5	6	42	20	14	31.5	

1C9EX – Metric female swivel 24° with O-ring

Heavy series – Metric swivel nut – ISO 12151-2

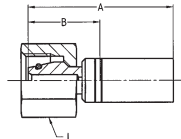

MATERIAL Galvanised steel with transparent Cr(IV)-free plating.
Other materials available on request.

Part No. #	DN size				Connection type						
	mm	inch	Thread size	Tube OD mm	A mm	B mm	J mm	Max. WP MPa			
1C9EX-6-012	2	-012	2.0	5/64	M14x1.5	6	32	21	17	63.0	
1C9EX-8-012	2	-012	2.0	5/64	M16x1.5	8	37	26	19	63.0	
1C9EX-8-02	3	-02	3.2	1/8	M16x1.5	8	32	22	19	63.0	
1C9EX-8-025	4	-025	4.0	5/32	M16x1.5	8	45	22	19	63.0	

11DEX – Metric standpipe

Light series

MATERIAL Galvanised steel with transparent Cr(IV)-free plating.
Other materials available on request.

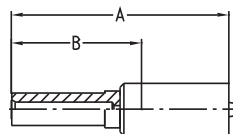

Part No. #	DN	size	mm	inch	Tube OD mm	A mm	B mm	Max. WP MPa
11DEX-4-012	2	-012	2.0	5/64	4	37	26	25.0
11DEX-4-025	4	-025	4.0	5/32	4	52	30	25.0
11DEX-6-025	4	-025	4.0	5/32	6	54	32	25.0

NOTE: Not recommended for new constructions. Please refer to end connections C3 or CA.

13DEX – Metric standpipe

Heavy series

MATERIAL Galvanised steel with transparent Cr(IV)-free plating.
Other materials available on request.

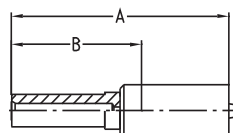

Part No. #	DN	size	mm	inch	Tube OD mm	A mm	B mm	Max. WP MPa
13DEX-6-012	2	-012	2.0	5/64	6	37	26	63.0
13DEX-8-012	2	-012	2.0	5/64	8	37	26	63.0
13DEX-8-025	4	-025	4.0	5/32	8	56	34	63.0

NOTE: Not recommended for new constructions. Please refer to end connections C9.



192EX – BSP female swivel 60° cone

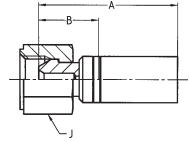

MATERIAL Galvanised steel with transparent Cr(IV)-free plating.
Other materials available on request.

Part No. #	DN size				Connection type Thread size	A mm	B mm	J mm	Max. WP MPa
	mm	inch	mm	inch					
192EX-4-025	4	-025	4.0	5/32	G 1/4	39	17	17	63.0
192EX-6-025	4	-025	4.0	5/32	G 3/8	40	18	19	55.0

1D9EX – BSP male DIN 3852 Form A

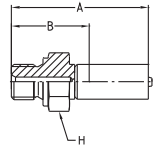

MATERIAL Galvanised steel with transparent Cr(IV)-free plating.
Other materials available on request.

Part No. #	DN size				Connection type Thread size	A mm	B mm	H mm	Max. WP MPa
	mm	inch	mm	inch					
1D9EX-4-012	2	-012	2.0	5/64	G 1/4	40	29	19	63.0

1BPEX – BSP female

Rigid

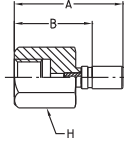

MATERIAL Galvanised steel with transparent Cr(IV)-free plating.
Other materials available on request.

Part No. #	DN size				Connection type Thread size	A mm	B mm	H mm	Max. WP MPa
	mm	inch	mm	inch					
1BPEX-4-012	2	-012	2.0	5/64	G 1/4	39	28	19	34.5

101EX – National Pipe Tapered (NPT) male

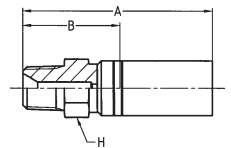

MATERIAL Galvanised steel with transparent Cr(IV)-free plating.
Other materials available on request.

Part No. #	DN size				Connection type Thread size	A mm	B mm	H mm	Max. WP MPa
	mm	inch	mm	inch					
101EX-4-012	2	-012	2.0	5/64	1/4 - 18NPTF	39	28	14	34.5
101EX-2-025	4	-025	4.0	5/32	1/8 - 27NPTF	46	24	12	34.5
101EX-4-025	4	-025	4.0	5/32	1/4 - 18NPTF	50	28	14	34.5



106EX – SAE (JIC) 37° female swivel UNF swivel nut

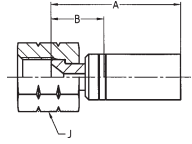

MATERIAL Galvanised steel with transparent Cr(IV)-free plating.
Other materials available on request.

Part No. #	DN size				Connection type		A mm	B mm	J mm	Max. WP MPa
	mm	inch	Thread size	Thread size						
106EX-3-012	2	-012	2.0	5/64	3/8 - 24UNF	23	12	14	41.0	
106EX-4-012	2	-012	2.0	5/64	7/16 - 20UNF	25	14	17	41.0	

1JCEX – O-Lok® ORFS swivel nut Short version – UNF swivel nut – ISO 12151-1

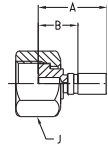

MATERIAL Galvanised steel with transparent Cr(IV)-free plating.
Other materials available on request.

Part No. #	DN size				Connection type		A mm	B mm	J mm	Max. WP MPa
	mm	inch	Thread size	Thread size	Tube OD inch					
1JCEX-4-012	2	-012	2.0	5/64	9/16 - 18 UNF	1/4	28	17	14	41.0
1JCEX-6-012	2	-012	2.0	5/64	11/16 - 16 UNF	3/8	26	15	22	41.0

149EX – Banjo union

DIN 7642

MATERIAL Galvanised steel with transparent Cr(IV)-free plating.
Other materials available on request.

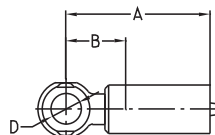

Part No. #	DN	size	mm	inch	Tube OD mm	A mm	B mm	Max. WP MPa
149EX-8-02	3	-02	3.2	1/8	8	23	13	20.0
149EX-10-025	4	-025	4.0	5/32	10	44	22	20.0

1R8EX – Quick connect fitting with metric swivel nut

Knurled

MATERIAL Galvanised steel with transparent Cr(IV)-free plating.
Other materials available on request.

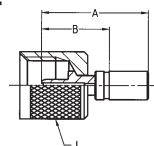

Part No. #	DN	size	mm	inch	Connection type Thread size	A mm	B mm	Max. WP MPa
1R8EX-11-012	2	-012	2.0	5/64	M16x2	30	19	63.0



1YPEX – Quick connect fitting with clip

MATERIAL Galvanised steel with transparent Cr(IV)-free plating.
Other materials available on request.

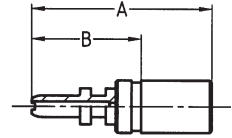

Part No. Fitting #	Part No. Clip #	DN size				mm	inch	Connection type Thread size	A mm	B mm	Max. WP MPa
1YPEX-3-012	HG-DN2	02	-12	2.0	5/64			-	28	17	63.0

1YREX – Quick connect fitting with metric swivel nut

MATERIAL Galvanised steel with transparent Cr(IV)-free plating.
Other materials available on request.

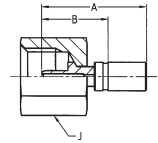

Part No. #	DN size				mm	inch	Connection type Thread size	A mm	B mm	J mm	Max. WP MPa
1YREX-10-012	2	-012	2.0	5/64			M16x1.5	30	19	19	63.0
1YREX-11-012	2	-012	2.0	5/64			M16x2	30	19	19	63.0



1C3NX – Metric female swivel 24°/60°

Light series – Metric swivel nut

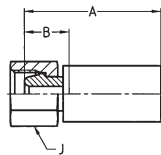

MATERIAL Galvanised steel with transparent Cr(IV)-free plating.
For fittings as mentioned above, but with stainless steel nipple (AISI 303), please add **C2W** to the Part No. Example: 1C3NX-8-04 **C2W**.
Other materials available on request.

Part No. #	DN size			mm inch		Connection type		A mm	B mm	J mm	Max. WP MPa
	mm	inch	Thread size	Tube OD mm							
1C3NX-8-04	6	-04	6.4	1/4	M14x1.5	8	46	18	17	25.0	
1C3NX-10-04	6	-04	6.4	1/4	M16x1.5	10	46	18	19	25.0	
1C3NX-10-05	8	-05	7.9	5/16	M16x1.5	10	46	18	19	25.0	
1C3NX-10-06	10	-06	9.5	3/8	M16x1.5	10	49	20	22	25.0	
1C3NX-12-06	10	-06	9.5	3/8	M18x1.5	12	48	19	22	25.0	
1C3NX-12-08	12	-08	12.7	1/2	M18x1.5	12	52	20	24	25.0	
1C3NX-15-08	12	-08	12.7	1/2	M22x1.5	15	51	20	27	25.0	

NX series

1C6NX – Metric female swivel 24°/60°

Heavy series – Metric swivel nut

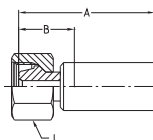

MATERIAL Galvanised steel with transparent Cr(IV)-free plating.
Other materials available on request.

Part No. #	DN size			mm inch		Connection type		A mm	B mm	J mm	Max. WP MPa
	mm	inch	Thread size	Tube OD mm							
1C6NX-8-04	6	-04	6.4	1/4	M16x1.5	8	58	26	19	63.0	
1C6NX-10-04	6	-04	6.4	1/4	M18x1.5	10	59	27	22	63.0	
1C6NX-12-05	8	-05	7.9	5/16	M20x1.5	12	58	24	24	63.0	
1C6NX-14-06	10	-06	9.5	3/8	M22x1.5	14	64	24	27	63.0	
1C6NX-16-08	12	-08	12.7	1/2	M24x1.5	16	67	24	30	40.0	
1C6NX-20-10	16	-10	15.9	5/8	M30x2	20	79	27	36	40.0	
1C6NX-25-12	20	-12	19.0	3/4	M36x2	25	81	30	46	40.0	
1C6NX-30-16	25	-16	25.4	1	M42x2	30	82	31	50	25.0	



1C9NX – Metric female swivel 24° with O-ring

Heavy series – Metric swivel nut – ISO 12151-2

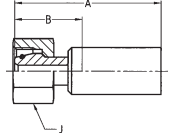

MATERIAL Galvanised steel with transparent Cr(IV)-free plating.
Other materials available on request.

Part No. #	DN size				Connection type		A mm	B mm	J mm	Max. WP MPa
	mm	inch	Thread size	Tube OD mm						
1C9NX-8-04	6	-04	6.4	1/4	M16x1.5	8	60	28	19	63.0
1C9NX-10-04	6	-04	6.4	1/4	M18x1.5	10	65	33	22	63.0
1C9NX-12-05	8	-05	7.9	5/16	M20x1.5	12	63	29	24	63.0
1C9NX-14-06	10	-06	9.5	3/8	M22x1.5	14	71	30	27	63.0
1C9NX-16-08	12	-08	12.7	1/2	M24x1.5	16	78	35	30	42.0
1C9NX-20-10	16	-10	15.9	5/8	M30x2	20	91	40	36	42.0
1C9NX-25-12	20	-12	19.0	3/4	M36x2	25	96	45	46	42.0
1C9NX-30-16	25	-16	25.4	1	M42x2	30	98	47	50	42.0
1C9NX-38-20	32	-20	31.8	1 1/4	M52x2	38	113	52	60	42.0

10CNX – Metric female swivel 24° with O-ring

45° elbow – Heavy series – Metric swivel nut – ISO 12151-2

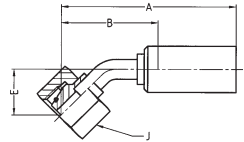

MATERIAL Galvanised steel with transparent Cr(IV)-free plating.
Other materials available on request.

Part No. #	DN size				Connection type		A mm	B mm	E mm	J mm	Max. WP MPa
	mm	inch	Thread size	Tube OD mm							
10CNX-10-04	6	-04	6.4	1/4	M18x1.5	10	82	50	24	22	63.0
10CNX-12-05	8	-05	7.9	5/16	M20x1.5	12	76	42	20	24	63.0
10CNX-12-06	10	-06	9.5	3/8	M20x1.5	12	81	40	19	24	63.0
10CNX-14-06	10	-06	9.5	3/8	M22x1.5	14	81	40	19	27	63.0
10CNX-16-08	12	-08	12.7	1/2	M24x1.5	16	96	53	23	30	42.0
10CNX-20-10	16	-10	15.9	5/8	M30x2	20	120	68	30	36	42.0
10CNX-25-12	20	-12	19.0	3/4	M36x2	25	137	85	37	46	42.0
10CNX-30-16	25	-16	25.4	1	M42x2	30	136	85	43	50	42.0

11CNX – Metric female swivel 24° with O-ring 90° elbow – Heavy series – Metric swivel nut – ISO 12151-2

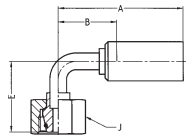

MATERIAL Galvanised steel with transparent Cr(IV)-free plating.
Other materials available on request.

Part No. #	DN size				Connection type		A mm	B mm	E mm	J mm	Max. WP MPa
	mm	inch	Thread size	Tube OD mm							
11CNX-10-04	6	-04	6.4	1/4	M18x1.5	10	66	34	36	22	63.0
11CNX-12-05	8	-05	7.9	5/16	M20x1.5	12	64	30	36	24	63.0
11CNX-14-06	10	-06	9.5	3/8	M22x1.5	14	71	30	36	27	63.0
11CNX-16-08	12	-08	12.7	1/2	M24x1.5	16	85	42	44	30	42.0
11CNX-20-10	16	-10	15.9	5/8	M30x2	20	105	53	61	36	42.0
11CNX-25-12	20	-12	19.0	3/4	M36x2	25	117	65	62	46	42.0
11CNX-30-16	25	-16	25.4	1	M42x2	30	116	65	76	50	42.0

NX series

1D2NX – Metric male 24° Heavy series – ISO 12151-2

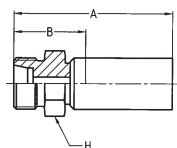

MATERIAL Galvanised steel with transparent Cr(IV)-free plating.
Other materials available on request.

Part No. #	DN size				Connection type		A mm	B mm	H mm	Max. WP MPa
	mm	inch	Thread size	Tube OD mm						
1D2NX-10-04	6	-04	6.4	1/4	M18x1.5	10	65	33	19	63.0
1D2NX-12-05	8	-05	7.9	5/16	M20x1.5	12	62	28	22	63.0
1D2NX-14-06	10	-06	9.5	3/8	M22x1.5	14	71	31	22	63.0
1D2NX-16-08	12	-08	12.7	1/2	M24x1.5	16	74	31	24	42.0
1D2NX-20-10	16	-10	15.9	5/8	M30x2	20	88	37	30	42.0
1D2NX-25-12	20	-12	19.0	3/4	M36x2	25	90	39	36	42.0
1D2NX-30-16	25	-16	25.4	1	M42x2	30	92	41	46	42.0



192NX – BSP female swivel 60° cone

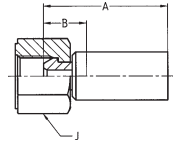

MATERIAL Galvanised steel with transparent Cr(IV)-free plating.
Other materials available on request.

Part No. #	DN size				Connection type Thread size 	A mm	B mm	J mm	Max. WP MPa
	mm	inch	mm	inch					
192NX-4-04	6	-04	6.4	1/4	G 1/4	56	25	19	63.0
192NX-6-05	8	-05	7.9	5/16	G 3/8	52	18	22	55.0
192NX-6-06	10	-06	9.5	3/8	G 3/8	59	19	22	55.0
192NX-8-06	10	-06	9.5	3/8	G 1/2	60	20	27	43.0
192NX-8-08	12	-08	12.7	1/2	G 1/2	63	20	27	43.0
192NX-12-10	16	-10	15.9	5/8	G 3/4	73	22	32	37.5
192NX-12-12	20	-12	19.0	3/4	G 3/4	77	26	32	37.5
192NX-16-12	20	-12	19.0	3/4	G 1	77	26	41	28.0
192NX-16-16	25	-16	25.4	1	G 1	88	27	41	28.0
192NX-20-16	25	-16	25.4	1	G 1 1/4	77	26	50	25.0

1U0NX – BSP female swivel (ballnose)

BSP swivel nut

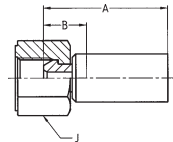

MATERIAL Galvanised steel with transparent Cr(IV)-free plating.
For fittings as mentioned above, but with stainless steel nipple
(AISI 303), please add **C2W** to the Part No. Example: 1U0NX-8-08 **C2W**.
Other materials available on request.

Part No. #	DN size				Connection type Thread size 	A mm	B mm	J mm	Max. WP MPa
	mm	inch	mm	inch					
1U0NX-4-04	6	-04	6.4	1/4	G 1/4	58	27	19	63.0
1U0NX-6-04	6	-04	6.4	1/4	G 3/8	58	27	27	55.0
1U0NX-6-05	8	-05	7.9	5/16	G 3/8	59	19	19	55.0
1U0NX-6-06	10	-06	9.5	3/8	G 3/8	61	20	22	55.0
1U0NX-8-06	10	-06	9.5	3/8	G 1/2	61	20	27	43.0
1U0NX-8-08	12	-08	12.7	1/2	G 1/2	61	22	27	43.0
1U0NX-12-10	16	-10	15.9	5/8	G 3/4	75	23	32	37.5
1U0NX-12-12	20	-12	19.0	3/4	G 3/4	78	23	32	37.5
1U0NX-16-12	20	-12	19.0	3/4	G 1	78	23	41	28.0

NX series

13BNX – BSP male 60° flare

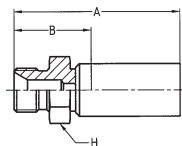

MATERIAL Galvanised steel with transparent Cr(IV)-free plating.
Other materials available on request.

Part No. #	DN size mm inch				Connection type	A mm	B mm	H mm	Max. WP MPa
	Thread size								
13BNX-4-04	6	-04	6.4	1/4	G 1/4	64	32	17	63.0
13BNX-6-05	8	-05	7.9	5/16	G 3/8	64	30	22	55.0
13BNX-6-06	10	-06	9.5	3/8	G 3/8	71	30	22	55.0
13BNX-8-06	10	-06	9.5	3/8	G 1/2	76	35	22	43.0
13BNX-8-08	12	-08	12.7	1/2	G 1/2	79	35	24	43.0
13BNX-12-10	16	-10	15.9	5/8	G 3/4	92	41	32	37.5
13BNX-12-12	20	-12	19.0	3/4	G 3/4	92	41	32	37.5
13BNX-16-12	20	-12	19.0	3/4	G 1	100	50	36	28.0
13BNX-16-16	25	-16	25.4	1	G 1	100	50	36	28.0
13BNX-20-16	25	-16	25.4	1	G 1 1/4	103	52	50	25.0
13BNX-20-20	32	-20	31.8	1 1/4	G 1 1/4	115	52	50	25.0
13BNX-24-20	32	-20	31.8	1 1/4	G 1 1/2	118	57	55	20.0

101NX – National Pipe Tapered (NPT) male

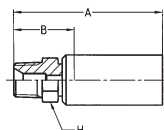

MATERIAL Galvanised steel with transparent Cr(IV)-free plating.
Other materials available on request.

Part No. #	DN size mm inch				Connection type	A mm	B mm	H mm	Max. WP MPa
	Thread size								
101NX-4-04	6	-04	6.4	1/4	1/4 - 18NPTF	65	33	14	34.5
101NX-6-05	8	-05	7.9	5/16	3/8 - 18NPTF	64	30	19	27.5
101NX-6-06	10	-06	9.5	3/8	3/8 - 18NPTF	71	31	19	27.5
101NX-8-06	10	-06	9.5	3/8	1/2 - 14NPTF	76	36	22	24.0
101NX-8-08	12	-08	12.7	1/2	1/2 - 14NPTF	79	37	22	24.0
101NX-12-10	16	-10	15.9	5/8	3/4 - 14NPTF	89	38	27	21.0
101NX-12-12	20	-12	19.0	3/4	3/4 - 14NPTF	91	40	27	21.0
101NX-16-12	20	-12	19.0	3/4	1 - 11 1/2NPTF	96	45	36	17.0
101NX-16-16	25	-16	25.4	1	1 - 11 1/2NPTF	96	45	36	17.0
101NX-20-16	25	-16	25.4	1	1 1/4 - 11 1/2NPTF	97	46	46	15.0



103NX – SAE (JIC) 37° male

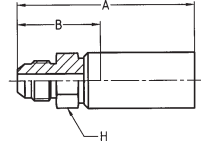

MATERIAL Galvanised steel with transparent Cr(IV)-free plating.
Other materials available on request.

Part No. #	DN size				Connection type Thread size 	A mm	B mm	H mm	Max. WP MPa
	mm	inch	mm	inch					
103NX-5-04	6	-04	6.4	1/4	1/2 - 20UNF	67	35	14	41.0
103NX-6-05	8	-05	7.9	5/16	9/16 - 18UNF	64	30	17	34.5
103NX-8-06	10	-06	9.5	3/8	3/4 - 16UNF	74	34	22	34.5
103NX-10-08	12	-08	12.7	1/2	7/8 - 14UNF	83	40	24	34.5
103NX-12-10	16	-10	15.9	5/8	1 1/16 - 12UNF	94	43	30	34.5
103NX-16-12	20	-12	19.0	3/4	1 5/16 - 12UNF	95	44	36	27.5
103NX-20-16	25	-16	25.4	1	1 5/8 - 12UNF	97	46	46	20.0
103NX-24-20	32	-20	31.8	1 1/4	1 7/8 - 12UNF	110	49	50	17.0

106NX – SAE (JIC) 37° female swivel UNF swivel nut

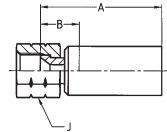

MATERIAL Galvanised steel with transparent Cr(IV)-free plating.
Other materials available on request.

Part No. #	DN size				Connection type Thread size 	A mm	B mm	J mm	Max. WP MPa
	mm	inch	mm	inch					
106NX-4-04	6	-04	6.4	1/4	7/16 - 20UNF	58	25	19	41.0
106NX-5-04	6	-04	6.4	1/4	1/2 - 20UNF	55	23	19	41.0
106NX-6-05	8	-05	7.9	5/16	9/16 - 18UNF	50	16	19	34.5
106NX-6-06	10	-06	9.5	3/8	9/16 - 18UNF	59	18	22	34.5
106NX-8-06	10	-06	9.5	3/8	3/4 - 16UNF	59	19	24	34.5
106NX-8-08	12	-08	12.7	1/2	3/4 - 16UNF	64	21	27	34.5
106NX-10-08	12	-08	12.7	1/2	7/8 - 14UNF	62	19	27	34.5
106NX-10-10	16	-10	15.9	5/8	7/8 - 14UNF	73	22	27	34.5
106NX-12-10	16	-10	15.9	5/8	1 1/16 - 12UNF	73	22	32	34.5
106NX-12-12	20	-12	19.0	3/4	1 1/16 - 12UNF	79	28	36	34.5
106NX-16-12	20	-12	19.0	3/4	1 5/16 - 12UNF	75	24	41	27.5
106NX-16-16	25	-16	25.4	1	1 5/16 - 12UNF	77	26	41	27.5
106NX-20-16	25	-16	25.4	1	1 5/8 - 12UNF	75	24	50	20.0

107NX – NPSM female swivel

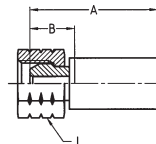

MATERIAL Galvanised steel with transparent Cr(IV)-free plating.
For fittings as mentioned above, but with stainless steel nipple
(AISI 303), please add **C2W** to the Part No. Example: 107NX-4-04 **C2W**.
Other materials available on request.

Part No. #	DN size				Connection type Thread size	A mm	B mm	J mm	Max. WP MPa
	mm	inch	mm	inch					
107NX-4-04	6	-04	6.4	1/4	1/4 - 18NPSM	47	19	19	34.5
107NX-6-05	8	-05	7.9	5/16	3/8 - 18NPSM	48	20	22	27.5
107NX-6-06	10	-06	9.5	3/8	3/8 - 18NPSM	50	21	22	27.5
107NX-8-08	12	-08	12.7	1/2	1/2 - 14NPSM	50	19	27	24.0
107NX-12-10	16	-10	15.9	5/8	3/4 - 14NPSM	53	22	32	21.0
107NX-12-12	20	-12	19.0	3/4	3/4 - 14NPSM	59	24	32	21.0

115NX – SAE (JIC) code 61 flange

Standard version – ISO 12151-3

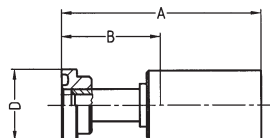

MATERIAL Galvanised steel with transparent Cr(IV)-free plating.
Other materials available on request.

Part No. #	DN size				A mm	B mm	D mm	Max. WP MPa
	mm	inch	mm	inch				
115NX-8-08	12	-08	12.7	1/2	87.0	44	30.2	34.5
115NX-12-10	16	-10	15.9	5/8	95.5	44	38.1	34.5
115NX-12-12	20	-12	19.0	3/4	99.5	48	38.1	34.5
115NX-16-16	25	-16	25.4	1	106.0	55	44.5	34.5
115NX-20-20	32	-20	31.8	1 1/4	117.0	56	50.8	27.5



117NX – SAE (JIC) code 61 flange 45° elbow – Standard version – ISO 12151-3

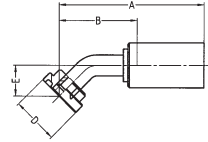

MATERIAL Galvanised steel with transparent Cr(IV)-free plating.
Other materials available on request.

Part No. #	DN	size	mm	inch	A mm	B mm	D mm	E mm	Max. WP MPa
117NX-8-08	12	-08	12.7	1/2	95.0	52.5	30.2	20	34.5
117NX-12-10	16	-10	15.9	5/8	113.5	62.0	38.1	24	34.5
117NX-12-12	20	-12	19.0	3/4	128.5	77.0	38.1	30	34.5
117NX-16-16	25	-16	25.4	1	125.0	74.0	44.5	32	34.5
117NX-20-20	32	-20	31.8	1 1/4	174.0	113.0	50.8	37	27.5

119NX – SAE (JIC) code 61 flange 90° elbow – Standard version – ISO 12151-3

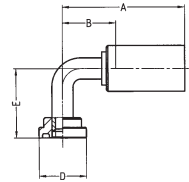

MATERIAL Galvanised steel with transparent Cr(IV)-free plating.
Other materials available on request.

Part No. #	DN	size	mm	inch	A mm	B mm	D mm	E mm	Max. WP MPa
119NX-8-08	12	-08	12.7	1/2	78.0	35	30.2	44	34.5
119NX-12-10	16	-10	15.9	5/8	98.5	47	38.1	54	34.5
119NX-12-12	20	-12	19.0	3/4	106.5	55	38.1	63	34.5
119NX-16-16	25	-16	25.4	1	116.0	65	44.5	69	34.5
119NX-20-20	32	-20	31.8	1 1/4	165.0	104	50.8	82	27.5

16ANX – SAE (JIC) code 61 flange

Heavy series – ISO 12151-3

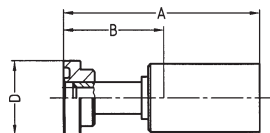

MATERIAL Galvanised steel with transparent Cr(IV)-free plating.
Other materials available on request.

Part No. #	DN	size	mm	inch	A mm	B mm	D mm	Max. WP MPa
16ANX-8-08	12	-08	12.7	1/2	88.0	45.0	31.7	41.0
16ANX-12-10	16	-10	15.9	5/8	103.0	51.5	41.3	41.0
16ANX-12-12	20	-12	19.0	3/4	103.5	52.0	41.3	41.0
16ANX-16-16	25	-16	25.4	1	113.0	62.0	47.6	41.0
16ANX-20-20	32	-20	31.8	1 1/4	126.0	65.0	54.0	41.0

16FNX – SAE (JIC) code 61 flange

45° elbow – Heavy series – ISO 12151-3

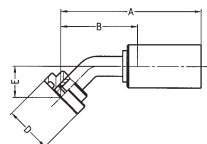

MATERIAL Galvanised steel with transparent Cr(IV)-free plating.
Other materials available on request.

Part No. #	DN	size	mm	inch	A mm	B mm	D mm	E mm	Max. WP MPa
16FNX-8-08	12	-08	12.7	1/2	95.0	52	31.7	21	41.0
16FNX-12-10	16	-10	15.9	5/8	117.5	66	41.3	28	41.0
16FNX-12-12	20	-12	19.0	3/4	130.5	79	41.3	32	41.0
16FNX-16-16	25	-16	25.4	1	130.0	79	47.6	37	41.0
16FNX-20-20	32	-20	31.8	1 1/4	180.0	119	54.0	44	41.0



16NNX – SAE (JIC) code 61 flange 90° elbow – Heavy series – ISO 12151-3

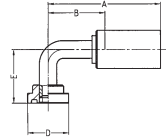

MATERIAL Galvanised steel with transparent Cr(IV)-free plating.
Other materials available on request.

Part No. #	DN	size	mm	inch	A mm	B mm	D mm	E mm	Max. WP MPa
16NNX-8-08	12	-08	12.7	1/2	87.0	44	31.7	41	41.0
16NNX-12-10	16	-10	15.9	5/8	104.5	53	41.3	54	41.0
16NNX-12-12	20	-12	19.0	3/4	116.5	65	41.3	63	41.0
16NNX-16-16	25	-16	25.4	1	116.0	65	47.6	75	41.0
16NNX-20-20	32	-20	31.8	1 1/4	165.0	104	54.0	91	41.0

NX series



1C3PX – Metric female swivel 24°/60°

Light series – Metric swivel nut

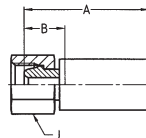

MATERIAL Galvanised steel with transparent Cr(IV)-free plating.
For fittings as mentioned above, but with stainless steel nipple (AISI 303), please add **C2W** to the Part No. Example: 1C3PX-6-03 **C2W**.
Other materials available on request.

Part No. #	DN size			mm		inch		Connection type		A mm	B mm	J mm	Max. WP MPa
	Thread size	Tube OD mm	Thread size	Tube OD mm	Thread size	Tube OD mm							
1C3PX-6-02	3	-02	3.2	1/8	M12x1.5	6	32	16	14	25.0			
1C3PX-6-03	5	-03	4.8	3/16	M12x1.5	6	43	18	14	25.0			
1C3PX-8-03	5	-03	4.8	3/16	M14x1.5	8	43	18	17	25.0			
1C3PX-10-03	5	-03	4.8	3/16	M16x1.5	10	43	18	19	25.0			
1C3PX-8-04	6	-04	6.4	1/4	M14x1.5	8	46	18	17	25.0			
1C3PX-10-04	6	-04	6.4	1/4	M16x1.5	10	46	18	19	25.0			
1C3PX-10-05	8	-05	7.9	5/16	M16x1.5	10	46	18	19	25.0			
1C3PX-10-06	10	-06	9.5	3/8	M16x1.5	10	49	20	22	25.0			
1C3PX-12-06	10	-06	9.5	3/8	M18x1.5	12	48	19	22	25.0			
1C3PX-12-08	12	-08	12.7	1/2	M18x1.5	12	52	20	24	25.0			
1C3PX-15-08	12	-08	12.7	1/2	M22x1.5	15	51	20	27	25.0			

PX series



1CAPX – Metric female swivel 24° with O-ring

Light series – Metric swivel nut – ISO 12151-2

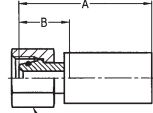

MATERIAL Galvanised steel with transparent Cr(IV)-free plating.
Other materials available on request.

Part No. #	DN size				Connection type		A mm	B mm	J mm	Max. WP MPa
	mm	inch	Thread size	Tube OD mm						
1CAPX-6-03	5	-03	4.8	3/16	M12x1.5	6	45	20	14	31.5
1CAPX-6-04	6	-04	6.4	1/4	M12x1.5	6	48	20	17	31.5
1CAPX-8-04	6	-04	6.4	1/4	M14x1.5	8	51	23	17	42.5
1CAPX-10-04	6	-04	6.4	1/4	M16x1.5	10	50	22	19	40.0
1CAPX-10-05	8	-05	7.9	5/16	M16x1.5	10	50	22	19	40.0
1CAPX-12-05	8	-05	7.9	5/16	M18x1.5	12	50	22	22	35.0
1CAPX-10-06	10	-06	9.5	3/8	M16x1.5	10	51	22	22	40.0
1CAPX-12-06	10	-06	9.5	3/8	M18x1.5	12	52	23	22	35.0
1CAPX-15-08	12	-08	12.7	1/2	M22x1.5	15	59	28	27	31.5
1CAPX-18-10	16	-10	15.9	5/8	M26x1.5	18	56	25	32	31.5
1CAPX-22-12	20	-12	19.0	3/4	M30x2	22	62	27	36	28.0
1CAPX-28-16	25	-16	25.4	1	M36x2	28	64	29	41	21.0

1C9PX – Metric female swivel 24° with O-ring

Heavy series – Metric swivel nut – ISO 12151-2

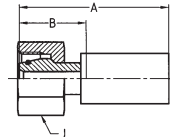

MATERIAL Galvanised steel with transparent Cr(IV)-free plating.
Other materials available on request.

Part No. #	DN size				Connection type		A mm	B mm	J mm	Max. WP MPa
	mm	inch	Thread size	Tube OD mm						
1C9PX-6-03	5	-03	4.8	3/16	M14x1.5	6	46	21	17	63.0
1C9PX-8-03	5	-03	4.8	3/16	M16x1.5	8	47	22	19	63.0
1C9PX-10-04	6	-04	6.4	1/4	M18x1.5	10	55	27	22	63.0
1C9PX-12-05	8	-05	7.9	5/16	M20x1.5	12	56	28	24	63.0
1C9PX-12-06	10	-06	9.5	3/8	M20x1.5	12	54	25	24	63.0
1C9PX-14-06	10	-06	9.5	3/8	M22x1.5	14	59	30	27	63.0
1C9PX-16-08	12	-08	12.7	1/2	M24x1.5	16	65	34	30	42.0
1C9PX-20-10	16	-10	15.9	5/8	M30x2	20	68	37	36	42.0
1C9PX-25-12	20	-12	19.0	3/4	M36x2	25	77	42	46	42.0
1C9PX-30-16	25	-16	25.4	1	M42x2	30	79	45	50	42.0

1CEPX – Metric female swivel 24° with O-ring

45° elbow – Light series – Metric swivel nut – ISO 12151-2

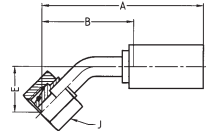

MATERIAL Galvanised steel with transparent Cr(IV)-free plating.
Other materials available on request.

Part No. #	DN size			inch	Connection type		A mm	B mm	E mm	J mm	Max. WP MPa
	mm	mm	mm		Thread size	Tube OD mm					
1CEPX-6-03	5	-03	4.8	3/16	M12x1.5	6	58	32	17	14	31.5
1CEPX-6-04	6	-04	6.4	1/4	M12x1.5	6	72	43	23	17	31.5
1CEPX-8-04	6	-04	6.4	1/4	M14x1.5	8	72	43	23	17	42.5
1CEPX-10-05	8	-05	7.9	5/16	M16x1.5	10	72	43	20	19	40.0
1CEPX-10-06	10	-06	9.5	3/8	M16x1.5	10	70	40	18	19	40.0
1CEPX-12-06	10	-06	9.5	3/8	M18x1.5	12	70	40	18	22	35.0
1CEPX-15-08	12	-08	12.7	1/2	M22x1.5	15	83	51	21	27	31.5
1CEPX-18-10	16	-10	15.9	5/8	M26x1.5	18	96	65	27	32	31.5
1CEPX-22-12	20	-12	19.0	3/4	M30x2	22	114	79	32	36	28.0
1CEPX-28-16	25	-16	25.4	1	M36x2	28	112	77	35	41	21.0

PX series

10CPX – Metric female swivel 24° with O-ring

45° elbow – Heavy series – Metric swivel nut – ISO 12151-2

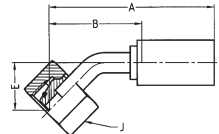

MATERIAL Galvanised steel with transparent Cr(IV)-free plating.
Other materials available on request.

Part No. #	DN size			inch	Connection type		A mm	B mm	E mm	J mm	Max. WP MPa
	mm	mm	mm		Thread size	Tube OD mm					
10CPX-8-03	5	-03	4.8	3/16	M16x1.5	8	61	35	20	19	63.0
10CPX-10-04	6	-04	6.4	1/4	M18x1.5	10	74	45	24	22	63.0
10CPX-12-05	8	-05	7.9	5/16	M20x1.5	12	71	42	20	24	63.0
10CPX-14-06	10	-06	9.5	3/8	M22x1.5	14	70	40	19	27	63.0
10CPX-16-08	12	-08	12.7	1/2	M24x1.5	16	85	53	23	30	42.0
10CPX-20-10	16	-10	15.9	5/8	M30x2	20	99	68	29	36	42.0



1CFPX – Metric female swivel 24° with O-ring

90° elbow – Light series – Metric swivel nut – ISO 12151-2

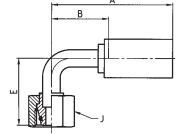

MATERIAL Galvanised steel with transparent Cr(IV)-free plating.
Other materials available on request.

Part No. #	DN size				Connection type		A mm	B mm	E mm	J mm	Max. WP MPa
	mm	inch	Thread size	Tube OD mm							
1CFPX-6-03	5	-03	4.8	3/16	M12x1.5	6	48	22	26	14	31.5
1CFPX-6-04	6	-04	6.4	3/8	M12x1.5	6	59	30	33	17	31.5
1CFPX-8-04	6	-04	6.4	1/4	M14x1.5	8	59	30	33	17	42.5
1CFPX-10-05	8	-05	7.9	5/16	M16x1.5	10	59	30	33	19	40.0
1CFPX-10-06	10	-06	9.5	3/8	M16x1.5	10	60	30	35	19	40.0
1CFPX-12-06	10	-06	9.5	3/8	M18x1.5	12	60	30	35	22	35.0
1CFPX-15-08	12	-08	12.7	1/2	M22x1.5	15	74	42	42	27	31.5
1CFPX-18-10	16	-10	15.9	5/8	M26x1.5	18	84	53	52	32	31.5
1CFPX-22-12	20	-12	19.0	3/4	M30x2	22	100	65	62	36	28.0
1CFPX-28-16	25	-16	25.4	1	M36x2	28	100	65	72	41	21.0

11CPX – Metric female swivel 24° with O-ring

90° elbow – Heavy series – Metric swivel nut – ISO 12151-2

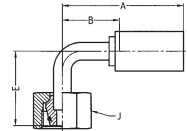

MATERIAL Galvanised steel with transparent Cr(IV)-free plating.
Other materials available on request.

Part No. #	DN size				Connection type		A mm	B mm	E mm	J mm	Max. WP MPa
	mm	inch	Thread size	Tube OD mm							
11CPX-8-03	5	-03	4.8	3/16	M16x1.5	8	48	22	28	19	63.0
11CPX-6-04	6	-04	6.4	1/4	M14x1.5	6	59	30	29	17	63.0
11CPX-10-04	6	-04	6.4	1/4	M18x1.5	10	59	30	36	22	63.0
11CPX-12-05	8	-05	7.9	5/16	M20x1.5	12	59	30	36	24	63.0
11CPX-14-06	10	-06	9.5	3/8	M22x1.5	14	60	30	36	27	63.0
11CPX-16-08	12	-08	12.7	1/2	M24x1.5	16	74	42	44	30	42.0
11CPX-20-10	16	-10	15.9	5/8	M30x2	20	84	53	61	36	42.0

1D0PX – Metric male 24°

Light series – ISO 12151-2

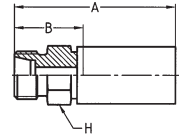

MATERIAL Galvanised steel with transparent Cr(IV)-free plating.
Other materials available on request.

Part No. #	DN size mm inch				Connection type		A mm	B mm	H mm	Max. WP MPa
	Thread size	Tube OD mm	mm	inch	mm	mm				
1D0PX-6-03	5	-03	4.8	3/16	M12x1.5	6	48	23	12	25.0
1D0PX-6-04	6	-04	6.4	1/4	M12x1.5	6	51	23	14	25.0
1D0PX-8-04	6	-04	6.4	1/4	M14x1.5	8	51	23	14	42.5
1D0PX-8-05	8	-05	7.9	5/16	M14x1.5	8	53	25	17	42.5
1D0PX-10-05	8	-05	7.9	5/16	M16x1.5	10	54	26	17	40.0
1D0PX-12-05	8	-05	7.9	5/16	M18x1.5	12	54	26	19	35.0
1D0PX-12-06	10	-06	9.5	3/8	M18x1.5	12	56	27	19	40.0
1D0PX-10-06	10	-06	9.5	3/8	M16x1.5	10	57	27	17	35.0
1D0PX-15-06	10	-06	9.5	3/8	M22x1.5	15	57	28	22	31.0
1D0PX-15-08	12	-08	12.7	1/2	M22x1.5	15	59	28	22	31.0
1D0PX-18-10	16	-10	15.9	5/8	M26x1.5	18	59	28	27	28.0
1D0PX-22-12	20	-12	19.0	3/4	M30x2	22	67	32	30	28.0
1D0PX-28-16	25	-16	25.4	1	M36x2	28	67	32	36	21.0

1D2PX – Metric male 24°

Heavy series – ISO 12151-2

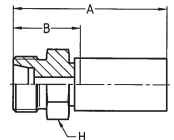

MATERIAL Galvanised steel with transparent Cr(IV)-free plating.
Other materials available on request.

Part No. #	DN size mm inch				Connection type		A mm	B mm	H mm	Max. WP MPa
	Thread size	Tube OD mm	mm	inch	mm	mm				
1D2PX-8-03	5	-03	4.8	3/16	M16x1.5	8	50	25	17	63.0
1D2PX-8-04	6	-04	6.4	1/4	M16x1.5	8	56	28	17	63.0
1D2PX-10-04	6	-04	6.4	1/4	M18x1.5	10	55	27	19	63.0
1D2PX-12-05	8	-05	7.9	5/16	M20x1.5	12	55	27	22	63.0
1D2PX-14-05	8	-05	7.9	5/16	M22x1.5	14	57	29	22	63.0
1D2PX-14-06	10	-06	9.5	3/8	M22x1.5	14	59	30	22	63.0
1D2PX-12-06	10	-06	9.5	3/8	M22x1.5	12	57	28	22	63.0
1D2PX-16-08	12	-08	12.7	1/2	M24x1.5	16	61	30	24	42.0
1D2PX-20-10	16	-10	15.9	5/8	M30x2	20	65	34	30	42.0
1D2PX-25-12	20	-12	19.0	3/4	M36x2	25	71	36	36	42.0
1D2PX-30-16	25	-16	25.4	1	M42x2	30	73	38	46	42.0



11DPX – Metric standpipe Light series

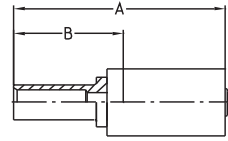

MATERIAL Galvanised steel with transparent Cr(IV)-free plating.
Other materials available on request.

Part No. #	DN size			Tube OD mm	A mm	B mm	Max. WP MPa	
	mm	inch	inch					
11DPX-6-03	5	-03	4.8	3/16	6	55	27	25.0
11DPX-8-04	6	-04	6.4	1/4	8	58	30	25.0
11DPX-10-05	8	-05	7.9	5/16	10	59	31	25.0
11DPX-10-06	10	-06	9.5	3/8	10	79	32	25.0
11DPX-12-06	10	-06	9.5	3/8	12	79	32	25.0
11DPX-15-08	12	-08	12.7	1/2	15	65	34	25.0
11DPX-18-10	16	-10	15.9	5/8	18	66	35	16.0
11DPX-22-12	20	-12	19.0	3/4	22	72	37	16.0
11DPX-28-16	25	-16	25.4	1	28	74	39	10.0

NOTE: Not recommended for new constructions. Please refer to end connections C3 or CA.

192PX – BSP female swivel 60° cone

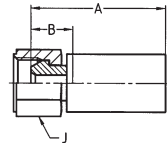

MATERIAL Galvanised steel with transparent Cr(IV)-free plating.
Other materials available on request.

Part No. #	DN size			Connection type Thread size	A mm	B mm	J mm	Max. WP MPa
	mm	inch	inch					
192PX-2-02	3	-02	3.2	1/8	26	11	12	55.0
192PX-2-03	5	-03	4.8	3/16	41	16	17	55.0
192PX-4-03	5	-03	4.8	3/16	42	16	17	63.0
192PX-4-04	6	-04	6.4	1/4	45	17	17	63.0
192PX-6-05	8	-05	7.9	5/16	45	17	19	55.0
192PX-6-06	10	-06	9.5	3/8	48	19	22	55.0
192PX-8-06	10	-06	9.5	3/8	48	19	27	43.0
192PX-8-08	12	-08	12.7	1/2	53	21	27	43.0
192PX-12-10	16	-10	15.9	5/8	50	19	32	35.0
192PX-12-12	20	-12	19.0	3/4	56	21	32	35.0
192PX-16-12	20	-12	19.0	3/4	56	22	41	28.0
192PX-16-16	25	-16	25.4	1	57	22	41	28.0
192PX-20-16	25	-16	25.4	1	58	24	50	21.0

1B1PX – BSP female swivel 60° cone 45° elbow

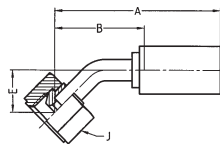

MATERIAL Galvanised steel with transparent Cr(IV)-free plating.
Other materials available on request.

Part No. #	DN size				Connection type Thread size	A mm	B mm	E mm	J mm	Max. WP MPa
	mm	inch	mm	inch						
1B1PX-4-03	5	-03	4.8	3/16	G 1/4	58	32	17	17	63.0
1B1PX-4-04	6	-04	6.4	1/4	G 1/4	70	41	21	17	63.0
1B1PX-6-05	8	-05	7.9	5/16	G 3/8	68	39	17	22	55.0
1B1PX-6-06	10	-06	9.5	3/8	G 3/8	66	36	14	22	55.0
1B1PX-8-06	10	-06	9.5	3/8	G 1/2	67	37	15	27	43.0
1B1PX-8-08	12	-08	12.7	1/2	G 1/2	86	54	18	27	43.0
1B1PX-12-10	16	-10	15.9	5/8	G 3/4	99	68	26	32	35.0
1B1PX-12-12	20	-12	19.0	3/4	G 3/4	117	82	30	32	35.0
1B1PX-16-16	25	-16	25.4	1	G 1	120	85	43	41	28.0
1B1PX-20-16	25	-16	25.4	1	G 1 1/4	116	81	34	50	21.0

PX series

1B2PX – BSP female swivel 60° cone 90° elbow

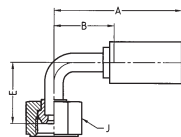

MATERIAL Galvanised steel with transparent Cr(IV)-free plating.
Other materials available on request.

Part No. #	DN size				Connection type Thread size	A mm	B mm	E mm	J mm	Max. WP MPa
	mm	inch	mm	inch						
1B2PX-4-03	5	-03	4.8	3/16	G 1/4	48	22	24	17	63.0
1B2PX-4-04	6	-04	6.4	1/4	G 1/4	59	30	30	17	63.0
1B2PX-6-05	8	-05	7.9	5/16	G 3/8	59	30	28	22	55.0
1B2PX-6-06	10	-06	9.5	3/8	G 3/8	60	30	30	22	55.0
1B2PX-8-06	10	-06	9.5	3/8	G 1/2	60	30	31	27	43.0
1B2PX-8-08	12	-08	12.7	1/2	G 1/2	74	42	38	27	43.0
1B2PX-12-10	16	-10	15.9	5/8	G 3/4	84	53	50	32	35.0
1B2PX-12-12	20	-12	19.0	3/4	G 3/4	100	65	60	32	35.0
1B2PX-20-16	25	-16	25.4	1	G 1 1/4	100	65	70	50	21.0



1B4PX – BSP female swivel 60° cone 90° compact elbow

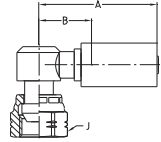

MATERIAL Galvanised steel with transparent Cr(IV)-free plating.
Other materials available on request.

Part No. #	DN size				Connection type Thread size 	A mm	B mm	J mm	Max. WP MPa
	mm	inch	mm	inch					
1B4PX-2-02	3	-02	3.2	1/8	G 1/8	26	11	12	55.0
1B4PX-2-03	5	-03	4.8	3/16	G 1/8	41	16	17	55.0
1B4PX-4-03	5	-03	4.8	3/16	G 1/4	42	16	17	63.0
1B4PX-4-04	6	-04	6.4	1/4	G 1/4	45	17	17	63.0

1U0PX – BSP female swivel (ballnose) BSP swivel nut

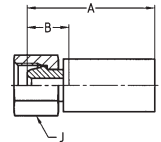

MATERIAL Galvanised steel with transparent Cr(IV)-free plating.
For fittings as mentioned above, but with stainless steel nipple
(AISI 303), please add **C2W** to the Part No. Example: 1U0PX-4-04 **C2W**.
Other materials available on request.

Part No. #	DN size				Connection type Thread size 	A mm	B mm	J mm	Max. WP MPa
	mm	inch	mm	inch					
1U0PX-4-02	3	-02	3.2	1/8	G 1/4	35	19	17	63.0
1U0PX-4-03	5	-03	4.8	3/16	G 1/4	42	16	17	63.0
1U0PX-4-04	6	-04	6.4	1/4	G 1/4	45	17	17	63.0
1U0PX-6-03	5	-03	4.8	3/16	G 3/8	43	18	19	55.0
1U0PX-6-04	6	-04	6.4	1/4	G 3/8	47	18	19	55.0
1U0PX-6-05	8	-05	7.9	5/16	G 3/8	45	17	19	55.0
1U0PX-6-06	10	-06	9.5	3/8	G 3/8	48	19	22	55.0
1U0PX-8-06	10	-06	9.5	3/8	G 1/2	48	19	27	43.0
1U0PX-8-08	12	-08	12.7	1/2	G 1/2	53	21	27	43.0
1U0PX-12-10	16	-10	15.9	5/8	G 3/4	50	19	32	35.0
1U0PX-12-12	20	-12	19.0	3/4	G 3/4	56	21	32	35.0
1U0PX-16-12	20	-12	19.0	3/4	G 1	56	22	41	25.0
1U0PX-16-16	25	-16	25.4	1	G 1	57	22	41	25.0
1U0PX-20-16	25	-16	25.4	1	G 1 1/4	58	24	50	21.0



1D9PX – BSP male

DIN 3852 Form A

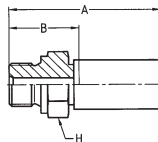

MATERIAL Galvanised steel with transparent Cr(IV)-free plating.
Other materials available on request.

Part No. #	DN size				Connection type Thread size	A mm	B mm	J mm	Max. WP MPa
	mm	inch	mm	inch					
1D9PX-2-02	3	-02	3.2	1/8	G 1/8	38	21	14	55.0
1D9PX-2-03	5	-03	4.8	3/16	G 1/8	48	22	14	55.0
1D9PX-4-03	5	-03	4.8	3/16	G 1/4	54	29	19	63.0
1D9PX-4-04	6	-04	6.4	1/4	G 1/4	57	29	19	63.0
1D9PX-6-05	8	-05	7.9	5/16	G 3/8	58	29	22	55.0
1D9PX-6-06	10	-06	9.5	3/8	G 3/8	60	30	22	55.0
1D9PX-8-06	10	-06	9.5	3/8	G 1/2	62	33	27	43.0
1D9PX-8-08	12	-08	12.7	1/2	G 1/2	64	33	27	43.0
1D9PX-12-10	16	-10	15.9	5/8	G 3/4	66	35	32	35.0
1D9PX-12-12	20	-12	19.0	3/4	G 3/4	72	37	32	35.0
1D9PX-16-12	20	-12	19.0	3/4	G 1	74	39	41	28.0
1D9PX-20-16	25	-16	25.4	1	G 1 1/4	76	41	50	21.0

PX series



13BPX – BSP male 60° flare

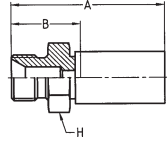



MATERIAL Galvanised steel with transparent Cr(IV)-free plating.
Other materials available on request.

Part No. #	DN size				Connection type Thread size 	A mm	B mm	H mm	Max. WP MPa
	mm	inch	mm	inch					
13BPX-2-03	5	-03	4.8	3/16	G 1/8	48	22	14	55.0
13BPX-4-03	5	-03	4.8	3/16	G 1/4	51	26	17	63.0
13BPX-4-04	6	-04	6.4	1/4	G 1/4	54	26	17	63.0
13BPX-6-05	8	-05	7.9	5/16	G 3/8	57	28	22	55.0
13BPX-6-06	10	-06	9.5	3/8	G 3/8	59	29	22	55.0
13BPX-8-06	10	-06	9.5	3/8	G 1/2	64	34	24	43.0
13BPX-8-08	12	-08	12.7	1/2	G 1/2	66	34	24	43.0
13BPX-12-10	16	-10	15.9	5/8	G 3/4	69	38	32	35.0
13BPX-12-12	20	-12	19.0	3/4	G 3/4	73	38	32	35.0
13BPX-16-12	20	-12	19.0	3/4	G 1	82	47	36	28.0
13BPX-16-16	25	-16	25.4	1	G 1	82	47	36	28.0
13BPX-20-16	25	-16	25.4	1	G 1 1/4	84	49	50	21.0

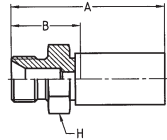
13BPX – BSP male 60° flare according to NEN 176



MATERIAL BF: Brass
C: Stainless steel (AISI 316 Ti)

Part No. #	DN size				Connection type		A mm	B mm	H mm	Max. WP MPa
	mm	inch	mm	inch	Thread size 	Tube OD mm 				
13BPX-8-04BF	6	-04	6.4	1/4	W21.8 x 1/14	8	60	32	24	27
13BPX-8-04C	6	-04	6.4	1/4	W21.8 x 1/14	8	60	32	24	43

NOTE: Only for CO₂ applications.



13BPX – BSP male 60° flare according to ISO/NFE 29650

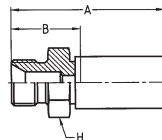

MATERIAL BF2: Brass
CS: Stainless steel (AISI 316 Ti)

Part No. #	DN size				Connection type		A mm	B mm	H mm	Max. WP MPa
	mm	inch	Thread size	Tube OD mm						
13BPX-8-04BF2	6	-04	6.4	1/4	21.7 x 1.814	8	63	35	24	27
13BPX-8-04CS	6	-04	6.4	1/4	21.7 x 1.814	8	63	35	24	43

NOTE: Only for CO₂ applications.

PX series

191PX – BSP male taper pipe

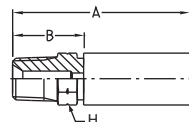

MATERIAL BF: Brass
C: Stainless steel (AISI 316 Ti)

Part No. #	DN size				Connection type		A mm	B mm	H mm	Max. WP MPa
	mm	inch	Thread size	Tube OD mm						
191PX-4-04BF	6	-04	6.4	1/4	R1/4	4	55	27	14	27
191PX-4-04C	6	-04	6.4	1/4	R1/4	4	55	27	14	43.0

NOTE: Only for CO₂ applications.



101PX – National Pipe Tapered (NPT) male

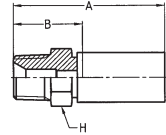

MATERIAL Galvanised steel with transparent Cr(IV)-free plating.
Other materials available on request.

Part No. #	DN size				Connection type Thread size	A mm	B mm	H mm	Max. WP MPa
	mm	inch	mm	inch					
101PX-2-03	5	-03	4.8	3/16	1/8 - 27NPTF	48	23	12	34.5
101PX-4-03	5	-03	4.8	3/16	1/4 - 18NPTF	52	27	14	34.5
101PX-4-04	6	-04	6.4	1/4	1/4 - 18NPTF	55	27	14	34.5
101PX-6-04	6	-04	6.4	1/4	3/8 - 18NPTF	57	29	19	27.5
101PX-6-05	8	-05	7.9	5/16	3/8 - 18NPTF	57	29	19	27.5
101PX-4-06	10	-06	9.5	3/8	1/4 - 18NPTF	57	28	14	34.5
101PX-6-06	10	-06	9.5	3/8	3/8 - 18NPTF	59	30	19	27.5
101PX-8-06	10	-06	9.5	3/8	1/2 - 14NPTF	64	35	22	24.0
101PX-6-08	12	-08	12.7	1/2	3/8 - 18NPTF	61	30	19	27.5
101PX-8-08	12	-08	12.7	1/2	1/2 - 14NPTF	66	35	22	24.0
101PX-12-10	16	-10	15.9	5/8	3/4 - 14NPTF	66	35	27	21.0
101PX-12-12	20	-12	19.0	3/4	3/4 - 14NPTF	70	35	27	21.0
101PX-16-12	20	-12	19.0	3/4	1 - 11 1/2NPTF	77	42	36	17.0
101PX-16-16	25	-16	25.4	1	1 - 11 1/2NPTF	77	42	36	17.0

103PX – SAE (JIC) 37° male

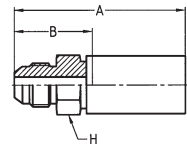

MATERIAL Galvanised steel with transparent Cr(IV)-free plating.
Other materials available on request.

Part No. #	DN size				Connection type Thread size	A mm	B mm	H mm	Max. WP MPa
	mm	inch	mm	inch					
103PX-4-03	5	-03	4.8	3/16	7/16 - 20UNF	52	27	14	41.0
103PX-5-04	6	-04	6.4	1/4	1/2 - 20UNF	57	29	14	41.0
103PX-6-04	6	-04	6.4	1/4	9/16 - 18UNF	57	29	17	34.5
103PX-6-05	8	-05	7.9	5/16	9/16 - 18UNF	57	29	17	34.5
103PX-8-06	10	-06	9.5	3/8	3/4 - 16UNF	62	33	22	34.5
103PX-10-08	12	-08	12.7	1/2	7/8 - 14UNF	70	38	24	34.5
103PX-12-10	16	-10	15.9	5/8	1 1/16 - 12UNF	71	40	30	34.5
103PX-16-12	20	-12	19.0	3/4	1 5/16 - 12UNF	76	41	36	27.5
103PX-20-16	25	-16	25.4	1	1 5/8 - 12UNF	78	43	46	20.0

PX series

106PX – SAE (JIC) 37° female swivel UNF swivel nut

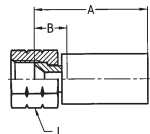

MATERIAL Galvanised steel with transparent Cr(IV)-free plating.
Other materials available on request.

Part No. #	DN size mm inch				Connection type	A mm	B mm	J mm	Max. WP MPa
					Thread size 				
106PX-4-02	3	-02	3.2	1/8	7/16 - 20UNF	29	13	17	41.0
106PX-4-03	5	-03	4.8	3/16	7/16 - 20UNF	40	15	17	41.0
106PX-4-04	6	-04	6.4	1/4	7/16 - 20UNF	43	15	17	41.0
106PX-5-04	6	-04	6.4	1/4	1/2 - 20UNF	43	15	19	41.0
106PX-6-05	8	-05	7.9	5/16	9/16 - 18UNF	45	17	19	34.5
106PX-6-06	10	-06	9.5	3/8	9/16 - 18UNF	47	18	19	34.5
106PX-8-06	10	-06	9.5	3/8	3/4 - 16UNF	48	19	24	34.5
106PX-10-08	12	-08	12.7	1/2	7/8 - 20UNF	49	18	27	34.5
106PX-12-10	16	-10	15.9	5/8	1 1/16 - 12UNF	50	19	32	34.5
106PX-16-12	20	-12	19.0	3/4	1 5/16 - 12UNF	56	22	41	27.5
106PX-20-16	25	-16	25.4	1	1 5/8 - 12UNF	56	22	50	20.0

107PX – NPSM female swivel

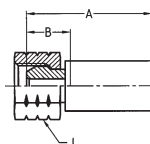

MATERIAL Galvanised steel with transparent Cr(IV)-free plating.
For fittings as mentioned above, but with stainless steel nipple
(AISI 303), please add **C2W** to the Part No. Example: 107PX-4-04 **C2W**.
Other materials available on request.



Part No. #	DN size mm inch				Connection type	A mm	B mm	J mm	Max. WP MPa
					Thread size 				
107PX-4-02	3	-02	3.2	1/8	1/4 - 18NPSM	36	20	17	34.5
107PX-4-03	5	-03	4.8	3/16	1/4 - 18NPSM	44	19	17	34.5
107PX-2-03	5	-03	4.8	3/16	1/8 - 27NPSM	47	21	17	34.5
107PX-4-04	6	-04	6.4	1/4	1/4 - 18NPSM	47	19	19	34.5
107PX-6-05	8	-05	7.9	5/16	3/8 - 18NPSM	48	20	22	27.5
107PX-6-06	10	-06	9.5	3/8	3/8 - 18NPSM	50	21	22	27.5
107PX-8-08	12	-08	12.7	1/2	1/2 - 14NPSM	50	19	27	24.0
107PX-12-10	16	-10	15.9	5/8	3/4 - 14NPSM	53	22	32	21.0
107PX-12-12	20	-12	19.0	3/4	3/4 - 14NPSM	59	24	32	21.0

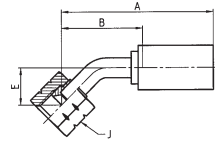

137PX – SAE (JIC) 37° female swivel 45° elbow – UNF swivel nut





MATERIAL Galvanised steel with transparent Cr(IV)-free plating.
Other materials available on request.

Part No. #	DN size				Connection type Thread size 	A mm	B mm	E mm	J mm 	Max. WP MPa 
	mm	inch	mm	inch						
137PX-4-03	5	-03	4.8	3/16	7/16 - 20UNF	57	31	16	17	41.0
137PX-5-04	6	-04	6.4	1/4	1/2 - 20UNF	70	41	21	19	41.0
137PX-6-05	8	-05	7.9	5/16	9/16 - 18UNF	67	38	16	19	34.5
137PX-8-06	10	-06	9.5	3/8	3/4 - 16UNF	67	37	15	24	34.5
137PX-10-08	12	-08	12.7	1/2	7/8 - 14UNF	81	49	19	27	34.5
137PX-12-10	16	-10	15.9	5/8	1 1/16 - 12UNF	96	65	27	32	34.5
137PX-16-12	20	-12	19.0	3/4	1 5/16 - 12UNF	114	79	32	41	27.5
137PX-20-16	25	-16	25.4	1	1 5/8 - 12UNF	113	78	36	50	20.0

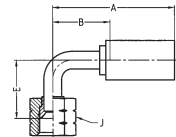
139PX – SAE (JIC) 37° female swivel 90° elbow – UNF swivel nut



MATERIAL Galvanised steel with transparent Cr(IV)-free plating.
Other materials available on request.

Part No. #	DN size				Connection type Thread size 	A mm	B mm	E mm	J mm 	Max. WP MPa 
	mm	inch	mm	inch						
139PX-4-03	5	-03	4.8	3/16	7/16 - 20 UNF	48	22	24	17	41.0
139PX-5-04	6	-04	6.4	1/4	1/2 - 20 UNF	59	30	31	19	41.0
139PX-6-05	8	-05	7.9	5/16	9/16 - 18 UNF	59	30	28	19	34.5
139PX-8-06	10	-06	9.5	3/8	3/4 - 16 UNF	60	30	31	24	34.5
139PX-10-08	12	-08	12.7	1/2	7/8 - 14 UNF	74	42	39	27	34.5
139PX-12-10	16	-10	15.9	5/8	1 1/16 - 12 UNF	84	53	52	32	34.5
139PX-16-12	20	-12	19.0	3/4	1 5/16 - 12 UNF	100	65	62	41	27.5
139PX-20-16	25	-16	25.4	1	1 5/8 - 12 UNF	100	65	73	50	20.0

1JCPX – O-Lok® ORFS swivel nut

Short version – UNF swivel nut – ISO 12151-1

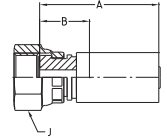

MATERIAL Galvanised steel with transparent Cr(IV)-free plating.
Other materials available on request.

Part No. #	DN				Connection type		A mm	B mm	J mm	Max. WP MPa
	size	mm	inch	Thread size	Tube OD inch					
1JCPX-4-03	5	-03	4.8	3/16	9/16 - 18 UNF	1/4	41	16	17	41.0
1JCPX-4-04	6	-04	6.4	1/4	9/16 - 18 UNF	1/4	44	16	17	41.0
1JCPX-6-04	6	-04	6.4	1/4	11/16 - 16 UNF	3/8	45	17	22	41.0
1JCPX-4-05	8	-05	7.9	5/16	9/16 - 18 UNF	1/4	44	16	17	41.0
1JCPX-6-05	8	-05	7.9	5/16	11/16 - 16 UNF	3/8	45	17	22	41.0
1JCPX-6-06	10	-06	9.5	3/8	11/16 - 16 UNF	3/8	47	18	22	41.0
1JCPX-8-06	10	-06	9.5	3/8	13/16 - 16 UNF	1/2	49	19	24	41.0
1JCPX-8-08	12	-08	12.7	1/2	13/16 - 16 UNF	1/2	51	19	24	41.0
1JCPX-12-12	20	-12	19.0	3/4	1 3/16 - 12 UNF	3/4	59	24	36	41.0
1JCPX-16-16	25	-16	25.4	1	1 7/16 - 12 UNF	1	60	25	41	41.0

1JSPX – O-Lok® ORFS swivel nut

Long version – UNF swivel nut – ISO 12151-1

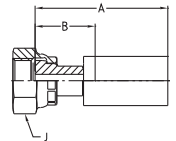

MATERIAL Galvanised steel with transparent Cr(IV)-free plating.
Other materials available on request.

Part No. #	DN				Connection type		A mm	B mm	J mm	Max. WP MPa
	size	mm	inch	Thread size	Tube OD inch					
1JSPX-4-03	5	-03	4.8	3/16	9/16 - 18 UNF	1/4	45	20	17	41.0
1JSPX-4-04	6	-04	6.4	1/4	9/16 - 18 UNF	1/4	50	21	17	41.0
1JSPX-6-04	6	-04	6.4	1/4	11/16 - 16 UNF	3/8	48	20	22	41.0
1JSPX-4-05	8	-05	7.9	5/16	9/16 - 18 UNF	1/4	50	21	17	41.0
1JSPX-6-05	8	-05	7.9	5/16	11/16 - 16 UNF	3/8	52	24	22	41.0
1JSPX-6-06	10	-06	9.5	3/8	11/16 - 16 UNF	3/8	53	23	22	41.0
1JSPX-8-06	10	-06	9.5	3/8	13/16 - 16 UNF	1/2	52	22	24	41.0
1JSPX-8-08	12	-08	12.7	1/2	13/16 - 16 UNF	1/2	55	23	24	41.0
1JSPX-12-12	20	-12	19.0	3/4	1 3/16 - 12 UNF	3/4	63	28	36	41.0
1JSPX-16-16	25	-16	25.4	1	1 7/16 - 12 UNF	1	67	32	41	41.0



1JMPX – O-Lok® ORFS male ISO 12151-1

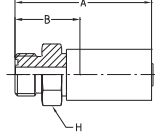

MATERIAL Galvanised steel with transparent Cr(IV)-free plating.
Other materials available on request.

Part No. #	DN size				Connection type		A mm	B mm	H mm	Max. WP MPa
	mm	inch	Thread size	Tube OD inch						
1JMPX-4-04	6	-04	6.4	1/4	9/16 - 18 UNF	1/4	51	23	14	41.0
1JMPX-6-06	10	-06	9.5	3/8	11/16 - 16 UNF	3/8	56	27	17	41.0
1JMPX-8-06	10	-06	9.5	3/8	13/16 - 16 UNF	1/2	58	29	22	41.0
1JMPX-8-08	12	-08	12.7	1/2	13/16 - 16 UNF	1/2	60	29	22	41.0
1JMPX-12-12	20	-12	19.0	3/4	1 3/16 - 12 UNF	3/4	70	35	30	41.0
1JMPX-16-16	25	-16	25.4	1	1 7/16 - 12 UNF	1	71	36	36	41.0

1J7PX – O-Lok® ORFS swivel nut 45° elbow – UNF swivel nut – ISO 12151-1

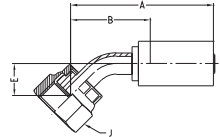

MATERIAL Galvanised steel with transparent Cr(IV)-free plating.
Other materials available on request.

Part No. #	DN size				Connection type		A mm	B mm	E mm	J mm	Max. WP MPa
	mm	inch	Thread size	Tube OD inch							
1J7PX-4-03	5	-03	4.8	3/16	9/16 - 18 UNF	1/4	56	30	15	17	41.0
1J7PX-4-04	6	-04	6.4	1/4	9/16 - 18 UNF	1/4	64	35	15	17	41.0
1J7PX-6-04	6	-04	6.4	1/4	11/16 - 16 UNF	3/8	64	35	15	22	41.0
1J7PX-4-05	8	-05	7.9	5/16	9/16 - 18 UNF	1/4	64	35	15	17	41.0
1J7PX-6-05	8	-05	7.9	5/16	11/16 - 16 UNF	3/8	64	35	17	22	41.0
1J7PX-6-06	10	-06	9.5	3/8	11/16 - 16 UNF	3/8	67	37	17	22	41.0
1J7PX-8-06	10	-06	9.5	3/8	13/16 - 16 UNF	1/2	67	37	17	24	41.0
1J7PX-8-08	12	-08	12.7	1/2	13/16 - 16 UNF	1/2	74	42	17	24	41.0
1J7PX-12-12	20	-12	19.0	3/4	1 3/16 - 12 UNF	3/4	100	65	25	36	41.0
1J7PX-16-16	25	-16	25.4	1	1 7/16 - 12 UNF	1	108	73	39	41	41.0

1J9PX – O-Lok® ORFS swivel nut

90° elbow – UNF swivel nut – ISO 12151-1

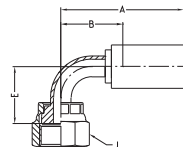

MATERIAL Galvanised steel with transparent Cr(IV)-free plating.
Other materials available on request.

Part No. #	DN size				Connection type		A mm	B mm	E mm	J mm	Max. WP MPa
	mm	inch	Thread size	Tube OD inch							
1J9PX-4-03	5	-03	4.8	3/16	9/16 - 18 UNF	1/4	48	22	23	17	41.0
1J9PX-4-04	6	-04	6.4	1/4	9/16 - 18 UNF	1/4	59	30	29	17	41.0
1J9PX-6-04	6	-04	6.4	1/4	11/16 - 16 UNF	3/8	59	30	29	22	41.0
1J9PX-4-05	8	-05	7.9	5/16	9/16 - 18 UNF	1/4	59	30	27	17	41.0
1J9PX-6-05	8	-05	7.9	5/16	11/16 - 16 UNF	3/8	59	30	27	22	41.0
1J9PX-6-06	10	-06	9.5	3/8	11/16 - 16 UNF	3/8	60	30	27	22	41.0
1J9PX-8-06	10	-06	9.5	3/8	13/16 - 16 UNF	1/2	60	30	27	24	41.0
1J9PX-8-08	12	-08	12.7	1/2	13/16 - 16 UNF	1/2	74	42	32	24	41.0
1J9PX-12-12	20	-12	19.0	3/4	1 3/16 - 12 UNF	3/4	100	65	60	36	41.0
1J9PX-16-16	25	-16	25.4	1	1 7/16 - 12 UNF	1	100	65	67	41	41.0

PX series

1GAPX – Female gas joint

according to NEN 176

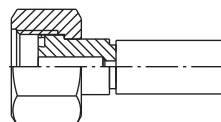

MATERIAL BF: Brass
C: Stainless steel (AISI 316 Ti)

Part No. #	DN size				Connection type		A mm	B mm	J mm	Max. WP MPa
	mm	inch	Thread size	Tube OD mm						
1GAPX-8-04BF	6	-04	6.4	1/4	W21.8 x 1/14	8	57	28	30	27
1GAPX-8-04C	6	-04	6.4	1/4	W21.8 x 1/14	8	57	28	30	27
1GAPX-12-04BF	6	-04	6.4	1/4	W24.32 x 1/14	12	57	28	32	27
1GAPX-12-04C	6	-04	6.4	1/4	W24.32 x 1/14	12	57	28	32	27

NOTE: Only for CO₂ applications.



1GAPX – Female gas joint

according to ISO/NFE 29650

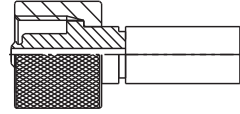

MATERIAL BF2: Brass
CS: Stainless steel (AISI 316 Ti)

Part No. #	DN size				Connection type		A mm	B mm	J mm	Max. WP MPa
	mm	inch	Thread size	Tube OD mm						
1GAPX-8-04BF2	6	-04	6.4	1/4	21.7 x 1.814	8	66	38	30	27
1GAPX-8-04CS	6	-04	6.4	1/4	21.7 x 1.814	8	66	38	30	43

NOTE: Only for CO₂ applications.

Chapter F**Accessories**

Bulk steel spring guards.....	F-2
PolyGuard anti-abrasion sleeve	F-3
ParKoil anti-abrasion sleeve.....	F-3
Fire protection sleeves	F-4
Special cut-to-length spring guards	F-5
Parflex CNG hose guard kit	F-6
Banjo bolt	F-6
Copper ring	F-7
Tape.....	F-7

Bulk steel spring guards

Spring guards made of electroplated hard drawn-steel wire used to protect the hose cover from abrasion and damages.

Part No. #	Guard ID mm 
SG-060	15.20
SG-066	16.75
SG-072	18.25
SG-084	21.30
SG-097	24.60
SG-106	26.90
SG-113	28.70
SG-122	30.95
SG-131	33.25
SG-155	39.35
SG-161	40.85
SG-166	42.15
SG-182	46.20
SG-209	53.05
SG-220	55.85
SG-232	58.90
SG-270	68.55
SG-292	74.20
SG-369	93.70



PolyGuard anti-abrasion sleeve

Heavy duty polyethylene sleeves for extreme applications

- Protects hose cover from abrasion and damages
- Easy mounting
- Reduces risk of kinking
- Resists oil, fuel, hydraulic liquids and normal solvents
- Ideal solution to bundle hoses

Part No. #	ID mm ⊙
HG-075	19.05
HG-100	25.40
HG-125	31.75
HG-150	38.10
HG-200	50.80
HG-350	88.90



ParKoil anti-abrasion sleeve

Cost-effective Anti-Abrasion Sleeve standard version

- Protects hose cover from abrasion and damages
- Easy mounting
- Reduces risk of kinking
- Resists oil, fuel, hydraulic liquids and normal solvents
- Ideal solution to bundle hoses



Part No. #	ID mm ⊙
PG-038	9.65
PG-050	12.70
PG-062	15.70
PG-075	19.05
PG-088	22.35
PG-100	25.40
PG-119	30.20
PG-138	35.05
PG-188	47.75

Fire protection sleeves

The firesleeve is constructed of a uniform single braid of glass fibre with a special fire-proof outside coating.

Used to protect hoses from heat, flying sparks, glowing metal scales etc.

Hose clamps for mounting required.

Part No. #	ID min mm 	OD max mm 
FS-F-10	14.7	24.6
FS-F-11	16.5	26.1
FS-F-12	18.0	27.6
FS-F-14	21.3	30.9
FS-F-16	24.4	35.0
FS-F-18	27.4	38.1
FS-F-20	30.7	40.3
FS-F-22	34.0	44.4
FS-F-24	37.1	48.2
FS-F-28	43.4	52.3
FS-F-32	49.8	58.9
FS-F-38	59.4	69.5
FS-F-40	62.5	70.8
FS-F-48	75.2	86.3
FS-F-60	94.2	105.4



Special cut-to-length spring guards
 (plated, hard drawn-steel wire)

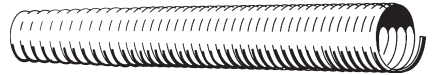

For hose types
 2040N/2040H/2245N/2370N/526BA

Part No. #	Hose type			Standard length mm
1709	2040N-02V22			100
1711/12.6	526BA-3			100
17135	2040H/N-04	526BA-4		140
17155	2245N-04			160
1717	2040H/N-05	526BA-6	2370N-04	170
1718.5	2040H/N-06	2370N-05		200
1721	2370N-06			200
1728	2040H-10			180

For CNG hoses

Part No. #	Guard ID mm 	Standard length mm
55SG-4	14.0	127.0
55SG-5	15.5	127.0
55SG-6	17.3	127.0
55SG-8	21.1	127.0
55SG-12	27.7	177.8
3PSG-4	13.7	158.8
3PSG-6	18.3	165.1
5PSG-4	16.0	158.8
5PSG-6	19.8	165.1
5PSG-8	22.9	165.1

Parflex CNG hose guard kit

Parflex CNG hose guard kit

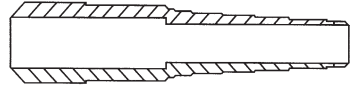

Use with Parflex CNG hose.

Each guard kit contains two vinyl hose guards and warning tag.

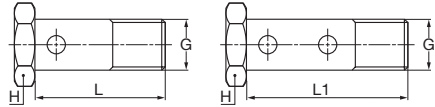

Part No. hose #	Part No. hose guard kit #
5CNG-4	CNGG5-4-KIT
5CNG-6	CNGG5-6-KIT
5CNG-8	CNGG5-8-KIT
5CNG-12	CNGG5-12-KIT
5CNG-16	CNGG5-16-KIT

Banjo bolt



AM / AR – Banjo bolt – metric/imperial DIN 7643

Material: steel, galvanised, chromium(VI) free plated

Part No. single #	Part No. double #	ID banjo mm	G thread size metric/imperial 	L single mm	L1 double mm	H mm 
AM-03	A2M3	8	M8x1	17	26	12
AM-04	A2M4	10	M10x1	19	30	14
AR-04		10	1/8	19		14
AM-06	A2M6	12	M12x1,5	26	38	17
AM-08	A2M8	14	M14x1,5	26	41	19
AR-08		14	1/4	26		19
AR-08C		14	1/4	26		19
AM-10	A2M10	16	M16x1,5	28	46	22
AR-10		17	3/8	29		22
AM-13		18	M18x1,5	32		24
AM-16		22	M22x1,5	40		27
AR-16		22	1/2	40		27
AM-20		26	M26x1,5	45		32

Copper ring for banjo bolt (Form A DIN 7603)

Part No. single #	ID banjo mm	G thread size metric/imperial 
853009-8	8	M8x1
853009-10	10	M10x1
853009-10	10	1/8
853009-12	12	M12x1,5
853009-14	14	M14x1,5
853009-14	14	1/4
853009-16	16	M16x1,5
853009-17	17	3/8
853009-18	18	M18x1,5
853009-22	22	M22x1,5
853009-21	22	1/2
853009-26	26	M26x1,5

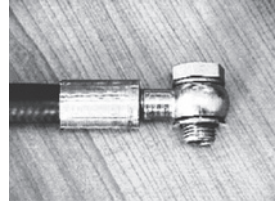

Tape

For fixing the pressure reinforcement

Part No. #	Type	Description
8.204	Tape	for regular thermoplastic hoses with wire reinforcement at normal temperatures
8.207	Glass silk tape	for PTFE hoses where high temperatures are applied
Tape-FV	Tape	fibre reinforced tape

Chapter G

Workshop equipment

Heavy-duty hose crimper TH8-380.E	G-2
KarryKrimp® 2 crimping press 85CE-06.....	G-3
Hand pump 85CE-0HP	G-3
Turbo air pump 85C-0AP	G-3
Power pump 82CE-0EP	G-3
PHastkrimp® crimping press 89CE-061	G-4
Parkrimp® 2 crimping press 83CE.....	G-4
Parflex® Parkrimp® dies	G-5
MiniKrimp® 94C-001-PFD	G-6
Hose crimping press HP-45	G-7
ST250 hose cutting tool	G-8
TH4-4 sleeve marking tool	G-8
SMM100 hose assembling machine	G-9
TH5-3 hose test rig	G-9
8.2 hose assembling accessories	G-10
PD-1-5MM pin gauges.....	G-10

Heavy-duty hose crimper TH8-380.E



Through the application of state-of-the-art innovative friction bearings, this machine is the perfect complement of the existing Parker machinery range (Parkrimp® system and Polykrimp machines). The TH8-380.E is a heavy-duty crimper for crimping all Parker hose types with 4 or 6 spiral steel wire layers.

Crimping force:	350 tons
Control:	Electronic with digital display
Open/Close:	High-speed up to 23 mm/s
Dimensions:	Length 1200 mm x width 600 mm x height 1600 mm
Weight:	750 kg without oil (+ 40 l hydraulic oil)
Tools:	This machine is equipped with the proven PB 232 and PB 239 die systems. The intermediate die set 232.239 L is supplied with the basic model.
Included:	Set of mirrors SHS Foot switch FU Workplace lamp LUS / LUF
Options:	Quick change system QDS 239 C QDS 239.3

Part number: TH8-380.E

KarryKrimp® 2 crimping press 85CE-061



KarryKrimp® 2 is portable, compact and ruggedly built. You have everything you need to crimp hoses from DN 6 to DN32. Model 85C-061 includes crimping machine, take-apart stand, die rings and connection hose with quick coupling.

For Parker hose with textile and steel wire reinforcements up to 4SP DN 32 and 4SH/100 R13 up to DN 25.

Complete with hose assembly and quick coupling, 2 die rings and take-apart stand.

Dimensions (with stand):

H 762.0 mm x W 355.6 mm x J 381.0 mm

Weight:

ca. 46 kg

Part No.:

85CE-061

The following pumps can be used with the KarryKrimp® 2 crimping press:



Hand pump 85CE-0HP

Working pressure: max. 70 MPa

Dimensions: L 539 mm x W 417 mm x H 151 mm

Weight: 11.6 kg

Tank capacity: 2294 ccm

Lever Force: 55 kg

Part No.:

85CE-0HP



Turbo air pump 85C-0AP

Working pressure: 70 MPa

Dimensions: L 320 mm x W 320 mm x H 480 mm

Weight: 8.4 kg

Tank capacity: 662 ccm

Compressed-air supply: 1/4-18NPTF thread

Part No.:

85C-0AP



Power pump 82CE-0EP

Working pressure: 70 MPa with 3/2 hand valve

Dimensions: L 320 mm x W 320 mm x H 480 mm

Weight: 12 kg

Tank capacity: 2000 cm²

Connection: single phase / 230 V

Part No.:

82CE-0EP

REMARKS

All pumps also suitable for KarryKrimp® 82C-061.

PHastkrimp® crimping press 89CE-061

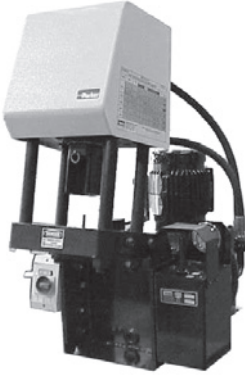

For Parker hose with textile and steel wire braids as well as spiral steel wire layers up to DN 32. With hydraulic device and base frame, but without dies.
High crimping rate.

PHastkrimp® crimping press with two die rings (silver and black):
Part No. 89CE-061

Technical Details:

Electrical power:	400 V / 16 A
Dimensions:	H 1477 mm x W 866 mm x D 1298 mm
Weight:	249 kg

Parkrimp® 2 crimping press 83CE-083

For Parker hose with textile and steel wire braids as well as spiral steel wire layers up to DN 50. With hydraulic device and base frame, but without dies.

Complete machine with power unit, but without die sets.
Bench mounted.

Technical Details:

Electrical power:	380 / 420 V - 3.0 KW - 50Hz
Electrical connection:	16 A
Dimensions:	H 1130 mm x W 490 mm x D 820 mm
Weight:	Packed: 392 kg Unpacked: 342 kg

Part No. 83CE-083

Power unit:
Part No. 83CE-380

Parflex® Parkrimp® dies

Parkrimp® dies are specifically engineered for Parflex® hose. The die segments are linked together, and each die is well defined with identification grooves to indicate the fitting series. Also, the dies are colour coded to specify the fitting size. These dies are for use with the Parkrimp®, KarryKrimp® and MiniKrimp® units.

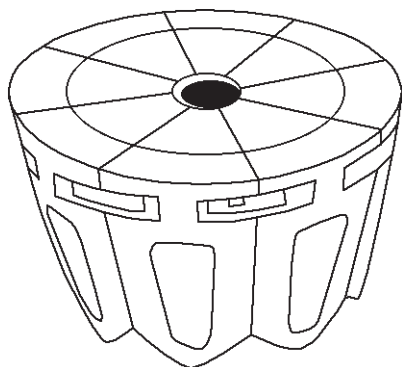

1 groove
55 series / 56 series

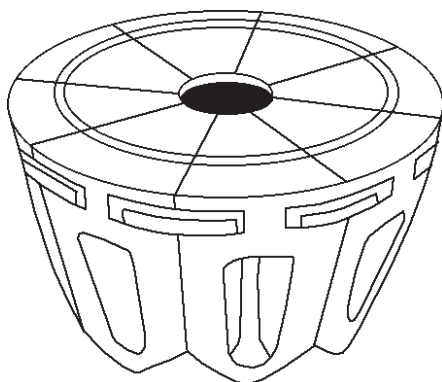

2 grooves
58 series

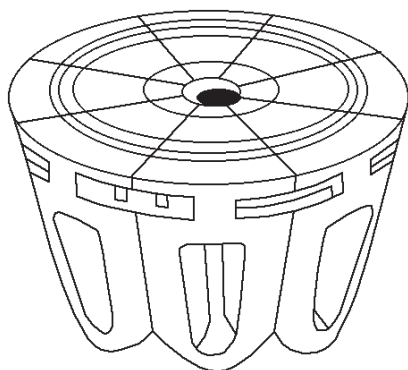

3 grooves
91N series, 93N series

Parkrimp® silver die ring
Part No.: 80C-R01

KarryKrimp® silver die ring
Part No.: 82C-R01
Used with all Parflex® hoses

NOTES

Parflex® dies have been designed for use with the silver die ring.
See Swage and Crimp Die Selection Chart for proper crimp or swage die part number, crimp diameter on pages H-3 to H-8.

MiniKrimp® 94C-001-PFD



Patent-No. 6715335 and D495938

MiniKrimp® is a portable, one piece crimper. Due to its light and very compact design the MiniKrimp® is easy to transport and provides a cost effective way to make hose assemblies in the field.

The MiniKrimp® is able to crimp the following fitting series: 55/56/57/58/91N and EH of the **polyflex®** Division product range, 43/46/48 and 26 of the HPDE product range.

Specifications:

Rating: 30 tons
Set-up time: 20 s

Dimensions:

Depth: 127 mm
Width: 178 mm
Height: 394 mm
Weight: 16 kg

Name: MiniKrimp®
Part No.: 94C-001-PFD

Hose crimping press HP45



Polyflex hose crimping press for hose sizes ranging from DN 2 to DN 20. Maximum pressing power approx. 150 t. For small batches, rubber and thermoplastic hose. The HP45 press is the preferred tool in repair shops.

Dimensions:

Length:	260 mm
Width:	200 mm
Height:	175 mm
Weight:	19 kg

Specifications:

Theoretical pressing power:	150 t
Max. aperture Ø:	44 mm
Aperture travel in Ø:	19 mm
Cylinder capacity:	0.28 l
Number of jaws:	8
Max. working pressure:	48 MPa
Working direction:	perpendicular from bottom
Stroke:	38 mm

Name:	Hose Crimping Press HP45
Part No.	80

Special accessories

- Z stand	80-ZB06
- carrying stand	80-ZB07
- 2-level hand pump	80-ZB01
- pneumatic pump with foot valve	80-ZB02
- coupling hose 1 m	80-ZB03
- coupling hose 1.5 m	80-ZB04
- quick coupling	80-ZB05

Crimping dies:

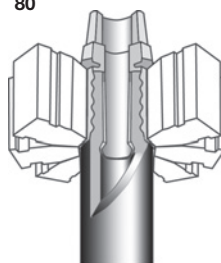

80-05
80-06
80-07
80-08
80-09
80-12
80-14
80-17
80-20
80-22
80-24
80-28
80-32

ST250 hose cutting tool

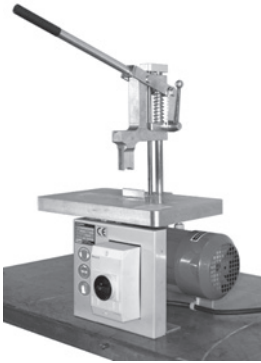

The **polyflex**® ST250 hose cutting tool is used for cutting off hose with metal or fibre reinforcement (up to six spiral layers) up to size DN 25. This hose cutting tool is suitable for small batches, single tubes and repair shops.

Part No.: ST250
Hose cutting tool with circular blade
Order No.: 50

TH4-4 hleeve marking tool



The **polyflex**® TH4-4 is for the permanent marking of hose assemblies or the crimp ferrule of the hose fitting. The standard model includes the table top device with base plate, height adjustable handwheel, fixable type holder, and a letter case with hardened steel type.

Part no.: TH4-4
Embossing tool with type holder (for one row of type) and letter case
Order No.: TH 4-4

SMM100 hose assembling machine

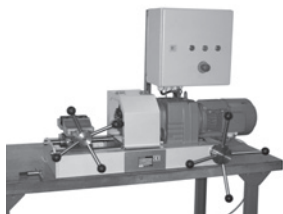

The **polyflex**® SMM100 hose assembling machine facilitates the attachment of fittings. The standard model includes electrical cabinet, foot switch, and safety three-segment chuck. The SMM 100 is suitable for fittings up to size DN 32.

Part No.: SMM100
Hose assembling machine with three-segment
chuck
Order No.: 60

TH 5-3 hose test rig



This workshop test rig is used for static pressure testing of hose assemblies ready for installation. Its test pressure ranges from 12 to 145 MPa. Almost all standard fittings can be tested.

Part No.: TH 5-3
Hose Test Rig
Order No.: TH 5-3

Test rigs for higher pressures on request

8.2 hose assembling accessories



The following accessories are recommended for proper assembly of **polyflex**[®] hose assemblies.

Name Hose Assembling Accessories
Order No.: 8.2

PD-1-5MM pin gauges

Workshop equipment



The set contains 41 single gauges from 1.0 to 5.0 mm in steps of 0.1 mm.

Specifications:

Material: Hardened steel
Shape: AH with cylindrical head
Length: 200 mm

Name Pin gauges
Order No.: PD-1-5MM

Chapter H

Technical information

Mounting systems overview.....	H-2
Crimping diameter and tooling selection chart.....	H-3
Assembly procedures – Reusable fittings.....	H-10
Assembly procedures – MiniKrimp®.....	H-14
Assembly procedures – Parkrimp® 2.....	H-19
Assembly procedures – Push-Lok® self-grip hose.....	H-26
Twinline and multiline hose separation instructions.....	H-27
Determining the hose length for over-the-sheaf applications.....	H-28
Selection, installation, and maintenance.....	H-29
Installation standards.....	H-31
Installation tips.....	H-33
Parker safety guide.....	H-34
Unit Conversion Table.....	H-43

Assembly systems overview

Parker thermoplastic hoses can be processed with various crimping systems. In addition to free adjustable crimpers Parker offers the safe and functional Parkrimp system for its one-piece fittings. For mounting systems and the related assembly instructions please see the following overview.

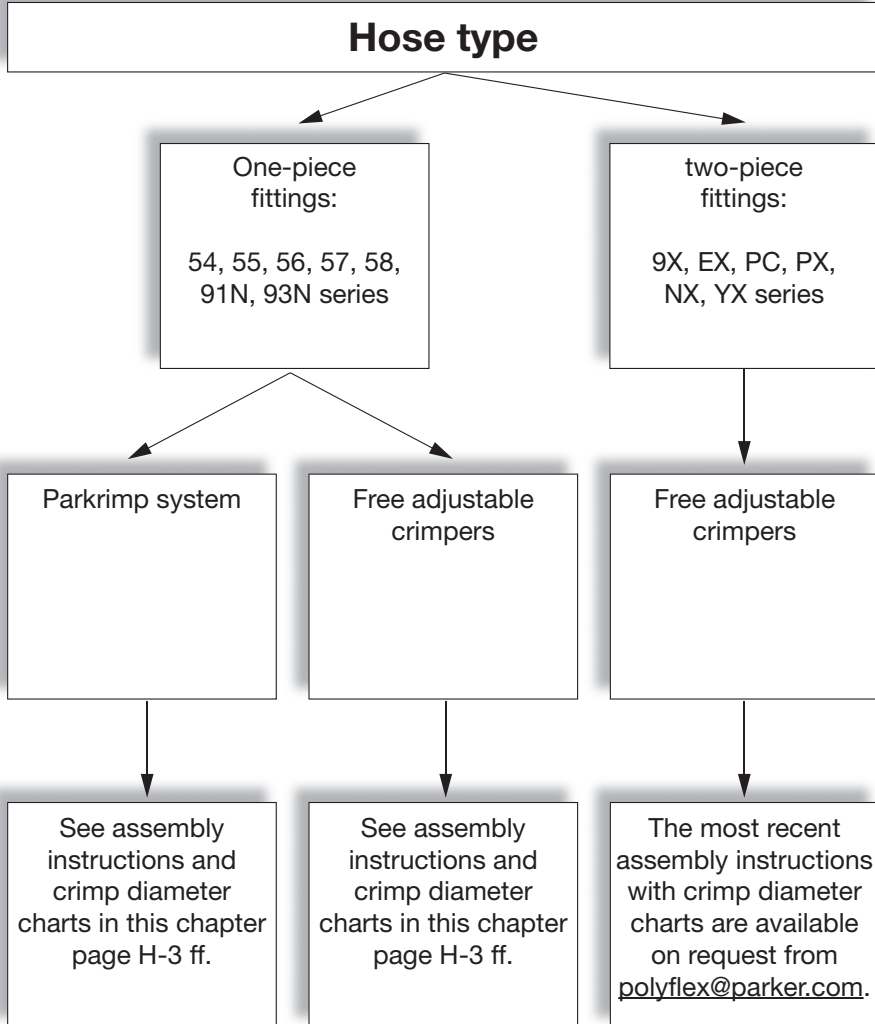

Please always use the most recent Parker crimping charts.

Crimping diameter and tooling selection chart for one-piece fittings

Hose type	Fitting series	Dies for Parkrimp®	Colour code	Dies for free adjustable presses, mm	Crimp diameter A. mm	Insertion depth B. mm
510A-3	55	80C-P03	gray	12	12.20/12.70	20.45/21.95
	56	80C-P03	gray	12	12.20/12.70	total length of ferrule
510A-4	55	80C-P04J	red	14	13.60/14.10	26.60/28.10
	56	80C-P04J	red	14	13.60/14.10	total length of ferrule
510A-6	55	80C-P06	yellow	17	17.15/17.65	27.60/29.10
	56	80C-P06	yellow	17	17.15/17.65	total length of ferrule
510A-8	55	80C-P08	blue	20	21.35/21.85	30.90/32.40
	56	80C-P08	blue	20	21.35/21.85	total length of ferrule
515H-3	54	-	-	9	10.4/10.6	14.10/14.90
515H-4	54	80C-544F	red	12	12.2/12.4	16.10/16.90
515H-5	54	-	-	12	13.7/13.9	19.20/20.00
515H-6	54	80C-546F	yellow	14	15.8/16.0	20.40/21.20
515H-8	54	80C-548F	blue	20	20.3/20.5	20.40/21.20
518C-2	57	80C-P02H	brown	9	10.10/10.40	13.85/14.35
518C-3	55	80C-P03	gray	12	12.20/12.70	20.45/21.95
	56	80C-P03	gray	12	12.20/12.70	total length of ferrule
518C-4	55	80C-P04J	red	14	13.60/14.10	26.60/28.10
	56	80C-P04J	red	14	13.60/14.10	total length of ferrule
518C-5	55	80C-P05	purple	14	15.75/16.25	27.70/29.20
	56	80C-P05	purple	14	15.75/16.25	total length of ferrule
518C-6	55	80C-P06	yellow	17	17.15/17.65	27.60/29.10
	56	80C-P06	yellow	17	17.15/17.65	total length of ferrule
518C-8	55	80C-P08	blue	20	21.35/21.85	30.90/32.40
	56	80C-P08	blue	20	21.35/21.85	total length of ferrule
518C-10	58	80C-P10H	orange	24	25.40/25.90	34.70/36.20
	56	80C-P10H	orange	24	25.40/25.90	total length of ferrule
518C-12	55	80C-P12	green	28	27.95/28.45	34.70/36.20
	56	80C-P12	green	28	27.95/28.45	total length of ferrule
518C-16	55	80C-P16	black	32	34.15/34.65	47.40/48.90
	56	80C-P16	black	32	34.15/34.65	total length of ferrule
520N-3	55	80C-P03	gray	12	12.20/12.70	20.45/21.95
	56	80C-P03	gray	12	12.20/12.70	total length of ferrule
520N-4 / 520N-4-WHT	55	80C-P04	red	14	14.25/14.75	26.60/28.10
	56	80C-P04	red	14	14.25/14.75	total length of ferrule
520N-5	55	80C-P05	purple	14	15.75/16.25	27.70/29.20
	56	80C-P05	purple	14	15.75/16.25	total length of ferrule

Crimping diameter and tooling selection chart

Hose type	Fitting series	Dies for Parkrimp®	Colour code	Dies for free adjustable presses, mm	Crimp diameter A. mm	Insertion depth B. mm
520N-6 / 520N-6-WHT	55	80C-P06	yellow	17	17.15/17.65	27.60/29.10
	56	80C-P06	yellow	17	17.15/17.65	total length of ferrule
520N-8	55	80C-P08	blue	20	21.35/21.85	30.90/32.40
	56	80C-P08	blue	20	21.35/21.85	total length of ferrule
526BA-3	55	80C-P03	gray	12	12.20/12.70	20.45/21.95
526BA-4	55	80C-P04	red	14	14.25/14.75	26.60/28.10
526BA-6	55	80C-P06	yellow	17	17.15/17.65	27.60/29.10
528N-3	55	80C-P03	gray	12	12.20/12.70	20.45/21.95
	56	80C-P03	gray	12	12.20/12.70	total length of ferrule
528N-4	55	80C-P04	red	14	14.25/14.75	26.60/28.10
	56	80C-P04	red	14	14.25/14.75	total length of ferrule
528N-5	55	80C-P05	purple	14	15.75/16.25	27.70/29.20
	56	80C-P05	purple	14	15.75/16.25	total length of ferrule
528N-6	55	80C-P06	yellow	17	17.15/17.65	27.60/29.10
	56	80C-P06	yellow	17	17.15/17.65	total length of ferrule
528N-8	55	80C-P08	blue	20	21.35/21.85	30.90/32.40
	56	80C-P08	blue	20	21.35/21.85	total length of ferrule
540N-2	57	80C-P02H	brown	9	10.10/10.40	13.85/14.35
540N-3	55	80C-P03	gray	12	12.20/12.70	20.45/21.95
	56	80C-P03	gray	12	12.20/12.70	total length of ferrule
540N-4	55	80C-P04	red	14	14.25/14.75	26.60/28.10
	56	80C-P04	red	14	14.25/14.75	total length of ferrule
540N-5	55	80C-P05	purple	14	15.75/16.25	27.70/29.20
	56	80C-P05	purple	14	15.75/16.25	total length of ferrule
540N-6	55	80C-P06	yellow	17	17.15/17.65	27.60/29.10
	56	80C-P06	yellow	17	17.15/17.65	total length of ferrule
540N-8	55	80C-P08	blue	20	21.35/21.85	30.90/32.40
	56	80C-P08	blue	20	21.35/21.85	total length of ferrule
540N-12	55	80C-P12	green	28	27.95/28.45	34.70/36.20
	56	80C-P12	green	28	27.95/28.45	total length of ferrule
550H-3	55	80C-P03	gray	12	12.20/12.70	20.45/21.95
	56	80C-P03	gray	12	12.20/12.70	total length of ferrule
550H-4	55	80C-P04	red	14	14.25/14.75	26.60/28.10
	56	80C-P04	red	14	14.25/14.75	total length of ferrule
550H-5	55	80C-P05	purple	14	15.75/16.25	27.70/29.20
	56	80C-P05	purple	14	15.75/16.25	total length of ferrule

Technical information

Hose type	Fitting series	Dies for Parkrimp®	Colour code	Dies for free adjustable presses, mm	Crimp diameter A, mm	Insertion depth B, mm
550H-6	55	80C-P06	yellow	17	17.15/17.65	27.60/29.10
	56	80C-P06	yellow	17	17.15/17.65	total length of ferrule
550H-8	55	80C-P08	blue	20	21.35/21.85	30.90/32.40
	56	80C-P08	blue	20	21.35/21.85	total length of ferrule
550H-10	58	80C-P10H	orange	24	25.40/25.90	34.70/36.20
	56	80C-P10H	orange	24	25.40/25.90	total length of ferrule
550H-12	55	80C-P12	green	28	27.95/28.45	34.70/36.20
	56	80C-P12	green	28	27.95/28.45	total length of ferrule
550H-16	55	80C-P16	black	32	34.15/34.65	47.40/48.90
	56	80C-P16	black	32	34.15/34.65	total length of ferrule
55LT-2	57	80C-P02H	brown	9	10.10/10.40	13.85/14.35
55LT-3	55	80C-P03	gray	12	12.20/12.70	20.45/21.95
	56	80C-P03	gray	12	12.20/12.70	total length of ferrule
55LT-4	55	80C-P04	red	14	14.25/14.75	26.60/28.10
	56	80C-P04	red	14	14.25/14.75	total length of ferrule
55LT-5	55	80C-P05	purple	14	15.75/16.25	27.70/29.20
	56	80C-P05	purple	14	15.75/16.25	total length of ferrule
55LT-6	55	80C-P06	yellow	17	17.15/17.65	27.60/29.10
	56	80C-P06	yellow	17	17.15/17.65	total length of ferrule
55LT-8	55	80C-P08	blue	20	21.35/21.85	30.90/32.40
	56	80C-P08	blue	20	21.35/21.85	total length of ferrule
55LT-12	55	80C-P12	green	28	27.95/28.45	34.70/36.20
	56	80C-P12	green	28	27.95/28.45	total length of ferrule
560-3	55	80C-P03	gray	12	12.20/12.70	20.45/21.95
	56	80C-P03	gray	12	12.20/12.70	total length of ferrule
560-4	55	80C-P04	red	14	14.25/14.75	26.60/28.10
	56	80C-P04	red	14	14.25/14.75	total length of ferrule
560-5	55	80C-P05	purple	14	15.75/16.25	27.70/29.20
	56	80C-P05	purple	14	15.75/16.25	total length of ferrule
560-6	55	80C-P06	yellow	17	17.15/17.65	27.60/29.10
	56	80C-P06	yellow	17	17.15/17.65	total length of ferrule
560-8	55	80C-P08J	blue	20	20.75/21.25	30.90/32.40
	56	80C-P08J	blue	20	20.75/21.25	total length of ferrule
560-10	55	80C-P10	orange	24	24.15/24.65	34.70/36.20
	56	80C-P10	orange	24	24.15/24.65	total length of ferrule
560-12	58	80C-P12H	green	28	29.20/29.70	34.70/36.20
	56	80C-P12H	green	28	29.20/29.70	total length of ferrule

Crimping diameter and tooling selection chart

Hose type	Fitting series	Dies for Parkrimp®	Colour code	Dies for free adjustable presses, mm	Crimp diameter A. mm	Insertion depth B. mm
575X-3	55	80C-P03	gray	12	12.20/12.70	20.45/21.95
	56	80C-P03	gray	12	12.20/12.70	total length of ferrule
575X-4	55	80C-P04	red	14	14.25/14.75	26.60/28.10
	56	80C-P04	red	14	14.25/14.75	total length of ferrule
575X-6	55	80C-P06	yellow	17	17.15/17.65	27.60/29.10
	56	80C-P06	yellow	17	17.15/17.65	total length of ferrule
575X-8	55	80C-P08	blue	20	21.35/21.85	30.90/32.40
	56	80C-P08	blue	20	21.35/21.85	total length of ferrule
580N-4	58	80C-P04H	red	17	16.95/17.45	26.60/28.10
	56	80C-P04H	red	17	16.95/17.45	total length of ferrule
580N-6	58	80C-P06H	yellow	20	19.95/20.45	27.60/29.10
	56	80C-P06H	yellow	20	19.95/20.45	total length of ferrule
580N-8	58	80C-P08H	blue	20	22.85/23.35	30.90/32.40
	56	80C-P08H	blue	20	22.85/23.35	total length of ferrule
580N-10	58	80C-P10H	orange	24	25.40/25.90	34.70/36.20
	56	80C-P10H	orange	24	25.40/25.90	total length of ferrule
580N-12	58	80C-P12H	green	28	29.20/29.70	34.70/36.20
	56	80C-P12H	green	28	29.20/29.70	total length of ferrule
580N-16	58	80C-P16H	black	36	37.45/37.95	47.40/48.90
	56	80C-P16H	black	36	37.45/37.95	total length of ferrule
588N-4	58	80C-P04H	red	17	16.95/17.45	26.60/28.10
	56	80C-P04H	red	17	16.95/17.45	total length of ferrule
588N-6	58	80C-P06H	yellow	20	19.95/20.45	27.60/29.10
	56	80C-P06H	yellow	20	19.95/20.45	total length of ferrule
588N-8	58	80C-P08H	blue	20	22.85/23.35	30.90/32.40
	56	80C-P08H	blue	20	22.85/23.35	total length of ferrule
588N-10	58	80C-P10H	orange	24	25.40/25.90	34.70/36.20
	56	80C-P10H	orange	24	25.40/25.90	total length of ferrule
588N-12	58	80C-P12H	green	28	29.20/29.70	34.70/36.20
	56	80C-P12H	green	28	29.20/29.70	total length of ferrule
588N-16	58	80C-P16H	black	36	37.45/37.95	47.40/48.90
	56	80C-P16H	black	36	37.45/37.95	total length of ferrule

Technical information

Hose type	Fitting series	Dies for Parkrimp®	Colour code	Dies for free adjustable presses, mm	Crimp diameter A. mm	Insertion depth B. mm
590-3	55	80C-P03	gray	12	12.20/12.70	20.45/21.95
	56	80C-P03	gray	12	12.20/12.70	total length of ferrule
590-4	55	80C-P04	red	14	14.25/14.75	26.60/28.10
	56	80C-P04	red	14	14.25/14.75	total length of ferrule
590-6	55	80C-P06	yellow	17	17.15/17.65	27.60/29.10
	56	80C-P06	yellow	17	17.15/17.65	total length of ferrule
590-8	55	80C-P08J	blue	20	20.75/21.25	30.90/32.40
	56	80C-P08J	blue	20	20.75/21.25	total length of ferrule
590-10	58	80C-P10H	orange	24	25.40/25.90	34.70/36.20
	56	80C-P10H	orange	24	25.40/25.90	total length of ferrule
590-12	58	80C-P12H	green	28	29.20/29.70	34.70/36.20
	56	80C-P12H	green	28	29.20/29.70	total length of ferrule
590-16	58	80C-P16J	black	36	36.85/37.35	47.40/48.90
	56	80C-P16J	black	36	36.85/37.35	total length of ferrule
1202LT-3	55	80C-P03	gray	12	12.20/12.70	20.45/21.95
	56	80C-P03	gray	12	12.20/12.70	total length of ferrule
1202LT-4	55	80C-P04	red	14	14.25/14.75	26.60/28.10
	56	80C-P04	red	14	14.25/14.75	total length of ferrule
1202LT-5	55	80C-P05	purple	14	15.75/16.25	27.70/29.20
	56	80C-P05	purple	14	15.75/16.25	total length of ferrule
1202LT-6	55	80C-P06	yellow	17	17.15/17.65	27.60/29.10
	56	80C-P06	yellow	17	17.15/17.65	total length of ferrule
1202LT-8	58	80C-P08H	blue	20	22.85/23.35	30.90/32.40
	56	80C-P08H	blue	20	22.85/23.35	total length of ferrule
2040H-03 / 2040N-03	55	80C-P03F	gray	12	11.55/12.05	20.45/21.95
	56	80C-P03F	gray	12	11.55/12.05	total length of ferrule
2040H-04 / 2040N-04	55	80C-P04	red	14	14.25/14.75	26.60/28.10
	56	80C-P04	red	14	14.25/14.75	total length of ferrule
2040H-05 / 2040N-05	55	80C-P05F	purple	14	15.55/16.05	27.70/29.20
	56	80C-P05F	purple	14	15.55/16.05	total length of ferrule
2040H-06 / 2040N-06	55	80C-P06	yellow	17	17.15/17.65	27.60/29.10
	56	80C-P06	yellow	17	17.15/17.65	total length of ferrule
2040H-08 / 2040N-08	55	80C-P08	blue	20	21.35/21.85	30.90/32.40
	56	80C-P08	blue	20	21.35/21.85	total length of ferrule

Crimping diameter and tooling selection chart

Hose type	Fitting series	Dies for Parkrimp®	Colour code	Dies for free adjustable presses, mm	Crimp diameter A, mm	Insertion depth B, mm
2030T-04R14	91N	80C-T04N	red	Note	8.50/9.00	3.3/4.3
2030T-05R14	91N	80C-T05N	purple	Note	9.80/10.30	3.3/4.3
2030T-06R14	91N	80C-T06N	yellow	Note	11.90/12.40	3.3/4.3
2030T-08R14	91N	80C-T08N	blue	Note	14.40/14.90	3.3/4.3
2030T-10R14	91N	80C-T10N	orange	Note	16.90/17.40	3.3/4.3
2030T-12R14	91N	80C-T12N	green	Note	20.00/20.50	4.2/5.2
2030T-16R14	91N	80C-T16N	black	Note	26.50/27.00	4.2/5.2
919U-4	91N	80C-T04N	red	Note	8.50/9.00	3.3/4.3
919U-6	91N	80C-T06N	yellow	Note	11.90/12.40	3.3/4.3
919U-8	91N	80C-T08N	blue	Note	14.40/14.90	3.3/4.3
919U-12	91N	80C-T12N	green	Note	20.00/20.50	4.2/5.2
919U-16	91N	80C-T16N	black	Note	26.50/27.00	4.2/5.2
929-4/929B-4	91N	80C-T04N	red	Note	8.50/9.00	3.3/4.3
929-6/929B-6	91N	80C-T06N	yellow	Note	11.90/12.40	3.3/4.3
929-8/929B-8	91N	80C-T08N	blue	Note	14.40/14.90	3.3/4.3
929-12/929B-12	91N	80C-T12N	green	Note	20.00/20.50	4.2/5.2
929-16/929B-16	91N	80C-T16H	black	Note	27.90/28.40	4.2/5.2
939-8/939B-8	93N	83C-T08*	blue	17	19.05/19.55	total length of ferrule
939-10/939B-10	93N	83C-T10*	orange	20	23.10/23.60	total length of ferrule
939-12/939B-12	93N	83C-T12*	green	28	27.70/28.20	total length of ferrule
939-16/939B-16	93N	83C-T16*	black	32	32.90/33.40	total length of ferrule
939-20/939B-20	93N	83C-T20*	white	40	40.10/40.60	total length of ferrule
939-24/939B-24	93N	83C-T24*	red	45	46.85/47.35	total length of ferrule
939-32/939B-32	93N	83C-T32*	green	60	61.20/61.70	total length of ferrule

Notes:

Special dies available on request.

* 83C-xxx dies are suited for Parkrimp II only.

Notes

The 54, 55, 57, 58 and 91N series fittings must be crimped over the indicated insertion depth only. The appearance after crimping is shown in the related figures below.

The 56 and 93N series fittings must be crimped over the total length of the ferrule. The appearance after crimping is shown in the related figure below.

In the Parkrimp system the correct insert depth is guaranteed by using the indicated crimping die.

Information given in the table are valid for steel, stainless steel and brass fittings.

For the free adjustable crimpers only dies with eight segments must be used – dies with six segments are not allowed.

When crimping with Parkrimp presses, use the silver die ring only.

The crimp diameter is to be measured in the centre of the crimping area (see figure).

Crimp diameter roundness shall not vary by more than 0.25 mm.

Parker reserves the right to alter crimp specifications.

Appearance of 54, 55, 57 and 58 fittings series after crimping

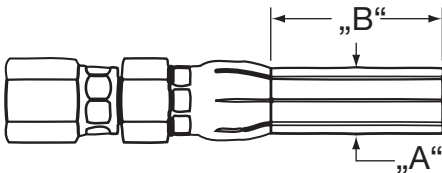

Appearance of 56 and 93N fittings series after crimping

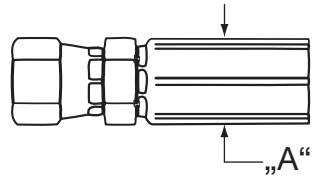

Appearance of 91N fittings series after crimping

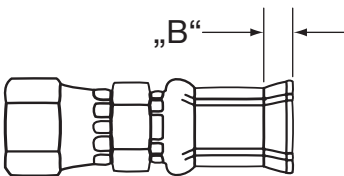

Assembly procedures – Reusable fittings

Measure and cut hose to length

1



Verify if type and size of the hose printed on the layline do match the work order.

NOTE

When calculating hose length, take into consideration the change in hose length (expansion/contraction) that may occur during pressurisation.

2
a/b

Using a flexible or rigid measuring tape, measure the length of hose required as follows:

- a. Verify required length of hose assembly with fittings.
- b. Subtract “Cutoff Allowance” of each fitting from hose assembly length. (Refer to Hose Fittings Tables for proper cutoff allowances)= dimension “B”

Example:

Hose assembly length with fittings =	500 mm
Fitting Cutoff Allowance (D0AB-12-6)	30 mm
Fitting Cutoff Allowance (1DAB-12-6)	44 mm
Total Cutoff Allowance	74 mm
500 mm – 74 mm	= 426 mm
Length of hose required	= 426 mm

2
c

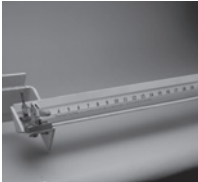

Secure hose in some type of fixture to ensure straightness.

2
d



Measure and mark hose.

CAUTION

Do not use abrasive wheels to cut hose. Abrasive wheels will damage core tube.

Technical information

3



Using a Parflex PHC hand cutter or other sharp cutter, cut hose squarely to correct length.

4

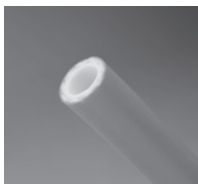

Visually inspect both ends of hose for squareness. Remove any burrs on core tube with a sharp knife.

Inspect Fittings

5



Verify if fitting part number(s) do match the work order.

6

a



Inspect socket for threads in shoulder, threads in shell and damage.

6

b



Inspect nipple for a through-hole, threads, hexagon and damage. Ensure swivel nut is properly crimped, has threads and turns freely.

Assemble hose

7



Using an SAE 20 lubricating oil, lightly lubricate inside and outside of hose end.

CAUTION

Ensure hose is installed in correct size hole of vice block. Clamping hose in a smaller hole will crush hose.

8

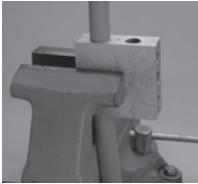

Using a Parker VBS or VBL vice block, place hose in proper hole of vice block and place in bench vice. Ensure enough hose extends from vice block to install socket.

CAUTION

Socket should be firm when tightened but not difficult to turn. If socket is difficult to install, check hose for proper lubrication. Re-apply lubricating oil as necessary. Installation of socket without proper lubrication may damage hose.

9
&
10



Using a wrench, screw socket onto hose counterclockwise until it bottoms. Ensure end of hose is against inside shoulder. Back off socket 1/4 turn clockwise.

CAUTION

When tightening socket in vice, do not over tighten vice jaws. Over tightening vice jaws will distort internal threads of socket and hamper installation of nipple.

11
&
12



Remove vice block and hose from vice. Place hexagon portion of socket into vice and tighten vice. Ensure socket extends past vice jaws enough to allow for installation of nipple.

13



Using an SAE 20 lubricating oil, generously lubricate nipple threads and hose ID.

CAUTION

Nipple should be firm when tightened but not difficult to turn. If nipple is difficult to install, check hose for proper lubrication. Re-apply lubricating oil as necessary. Installation of nipple without proper lubrication will damage core tube.

14

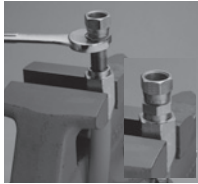

Using a wrench on the nipple hexagon, screw nipple into socket clockwise until nipple bottoms against socket shoulder.

Measure and inspect hose assembly15
&
16

Measure and verify hose assembly length matches work order. Pressure test hose assembly if required.

Assembly procedures – MiniKrimp®

Measure and cut hose to length

1



Verify if type and size of the hose printed on the layline do match the work order.

NOTE

When calculating hose length, take into consideration the change in hose length (expansion/contraction) that may occur during pressurisation.

2
a/b

Using a flexible or rigid measuring tape, measure the length of hose required as follows:

- Verify required length of hose assembly with fittings.
- Subtract “Cutoff Allowance” of each fitting from hose assembly length. (Refer to Hose Fittings Tables for proper cutoff allowances)= dimension “B”

Example:

Hose assembly length with fittings =	500 mm
Fitting Cutoff Allowance (1B255-6-6)	36 mm
Fitting Cutoff Allowance (2D955-6-6)	27 mm
Total Cutoff Allowance	63 mm
500 mm – 63 mm	= 437 mm
Length of hose required	= 437 mm

2
c

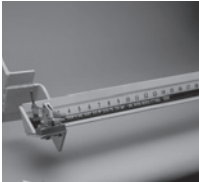

Secure hose in some type of fixture to ensure straightness.

2
d



Measure and mark hose.

CAUTION

Do not use abrasive wheels to cut hose. Abrasive wheels will damage core tube.

3



Using a Parflex PHC hand cutter or other sharp cutter, cut hose squarely to correct length.

4

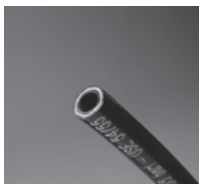

Visually inspect both ends of hose for squareness. Remove any burrs on core tube with a sharp knife.

Inspect fittings

5
&
6

Verify if fitting part number(s) do match the work order. Visually inspect fitting(s) for a through-hole, threads and damage.

Assemble hose

7



Mark hose end with proper insertion depth line. (Insertion depth = dimension "A" minus "B" according to hose fitting tables in chapters B to E)

WARNING

Do not use lubricating oil when installing fittings on hose used in oxygen service. When installing fittings on hose used in oxygen service lubricate with a non-oil based soap solution. Failure to do so may result in an explosion and personal injury when hose is used.

8



Using an SAE 20 lubricating oil, lightly lubricate inside of hose end. (Use non-oil based soap solution for oxygen service.)

9



Push hose into fitting all the way to depth insertion mark. (If fitting does not readily slide onto hose, perform the next step.)

10
a



Tap fitting onto hose as follows:
Using Parker VBS or VBL vice blocks, place hose with fitting into proper hole of vice block and place in bench vice.

CAUTION

Ensure hose extends from vice blocks only enough to clear depth insertion mark. Failure to do this may result in harmful kinking to the hose.

10
b
&
11



Using a rubber mallet, tap fitting onto hose until bottom of fitting shell is aligned with depth insertion mark.
Repeat Steps 7-10 for other end of hose if required.

NOTE

The following steps are performed using the Parker MiniKrimp®.

The MiniKrimp® crimping machine must only be set-up and operated by qualified and/or authorised staff. Parker will not accept warranty for the improper operation of MiniKrimp®.

12

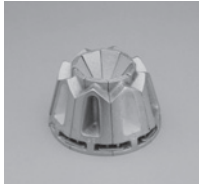

1. Select proper die set. For Parflex®-/polyflex® hose see Hose Crimp Assembly Tool Selection Chart in this manual.

Note: Die sets are colour coded by size.

13



2. Using a molybdenum disulfide type grease, apply a thin layer of grease to the die bowl.
Place selected die set into the bowl.

14



3. Place proper die ring on top of the selected die set. See Hose Crimp Assembly Tool Selection Chart in this manual for proper die ring selection.

15



4. Slide pusher into place onto shoulder bolt.

16



5. Position the hose and fitting in dies from below.

17

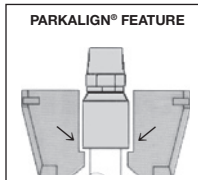

6. Align fitting so that the shell rests on die step.

18

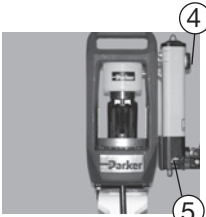

7. Open functional switch (4) on the pump and close the shut-off valve (5).

19



8. While holding hose and fitting into position on the step, begin pumping hand pump until die ring contacts base plate.

20



9. Release pressure by opening the shut-off valve (5) and remove finished assembly. Check crimp diameter.

21



10. Measure crimp diameter of each fitting at the top, middle and bottom of the shell. Take measurements at a minimum of three places around the shell circumference. Verify crimp diameter is within tolerances. For Parflex® hoses see Parflex Hose Crimp Assembly Tool Selection Chart in this manual.

Notes:

- Hose assemblies must be checked for cleanliness and should be free of all foreign particles.
- Parker Hannifin will not accept responsibility for the operation of, or provide warranty coverage for, a crimper that is operated by a power unit other than equipment supplied by Parker Hannifin for the express purpose of operating that crimper.

Assembly procedures – Parkrimp® 2

Measure and cut hose to length



Verify if type and size of the hose printed on the layline do match the work order.

NOTE

When calculating hose length, take into consideration the change in hose length (expansion/contraction) that may occur during pressurisation.

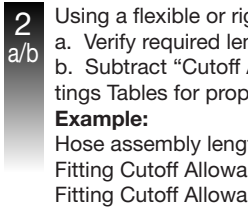

Using a flexible or rigid measuring tape, measure the length of hose required as follows:

- Verify required length of hose assembly with fittings.
- Subtract “Cutoff Allowance” of each fitting from hose assembly length. (Refer to Hose Fittings Tables for proper cutoff allowances)= dimension “B”

Example:

Hose assembly length with fittings =	500 mm
Fitting Cutoff Allowance (1B255-6-6)	36 mm
Fitting Cutoff Allowance (2D955-6-6)	27 mm
<u>Total Cutoff Allowance</u>	<u>63 mm</u>
500 mm – 63 mm	= 437 mm
Length of hose required	= 437 mm

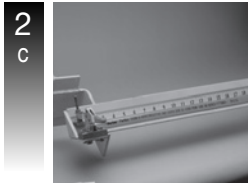

Secure hose in some type of fixture to ensure straightness.

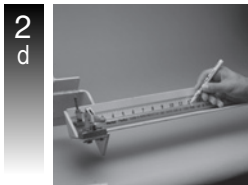

Measure and mark hose.

CAUTION

Do not use abrasive wheels to cut hose. Abrasive wheels will damage core tube.

3



Using a Parflex PHC hand cutter or other sharp cutter, cut hose squarely to correct length.

4

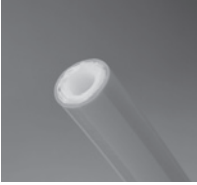

Visually inspect both ends of hose for squareness. Remove any burrs on core tube with a sharp knife.

Inspect fittings

5
&
6



Verify if fitting part number(s) do match the work order.

Assemble hose

7



Mark hose end with proper insertion depth line. (Insertion depth = dimension "A" minus "B" according to hose fitting tables in chapters B to E)

WARNING

Do not use lubricating oil when installing fittings on hose used in oxygen service. When installing fittings on hose used in oxygen service lubricate with a non-oil based soap solution. Failure to do so may result in an explosion and personal injury when hose is used.

8



Using an SAE 20 lubricating oil, lightly lubricate inside of hose end. (Use soap solution for oxygen service.)

9



Push hose into fitting all the way to depth insertion mark. (If fitting does not readily slide onto hose, perform the next step.)

10
a

Tap fitting onto hose as follows:
 Using Parker VBS or VBL vice blocks, place hose with fitting into proper hole of vice block and place in bench vice.

CAUTION

Ensure hose extends from vice blocks only enough to clear depth insertion mark. Failure to do this may result in harmful kinking of hose.

10
b & 11

Using a rubber mallet, tap fitting onto hose until bottom of fitting shell is aligned with depth insertion mark.
 Repeat Steps 7-10 for other end of hose if required.

NOTE

- The following steps are performed using the Parker ParKrimp® 2.
- Pusher slide pin is located inside rear of pusher.

VORSICHT

Do not use the black spacer ring on Parflex® fittings. Use of the black spacer ring will result in improperly crimped fittings and hose assemblies.

12

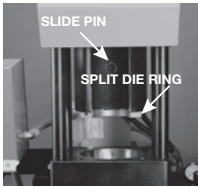

With pusher in full up position, position rear half of split die ring in rear of pusher. Lock ring in position by pushing in slide pin.

NOTE

When installing adaptor bowl, tilt bowl toward back of crimper during insertion.

13

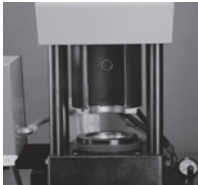

Install adaptor bowl in base plate of crimper for hose sizes 4 through 20.

14



Using a molybdenum disulfide type grease, apply a thin layer of grease on inside of adaptor bowl.

15



Select proper Parkrimp® die set. (See Swage and Crimp Die Selection Chart in this catalog section for proper part number selection.)

16

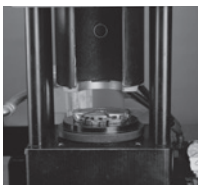

Place die set into bowl.

CAUTION

When crimping stainless steel fittings, lubricate dies with Parker 702 Oil. Failure to do so may result in damage to fittings.

17



Lower rear half of split die ring onto dies by pulling slide pin forward.

NOTE

When crimping bent tube fittings, front half of split die ring and front half of die set must be removed to insert and remove bent tube fittings.

18

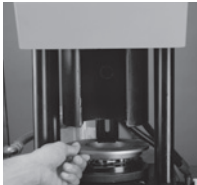

Insert front half of split die ring aligning pin in rear half with hole in front half.

CAUTION

When positioning fitting in die, ensure bottom of shell rests on die step. Failure to do so will result in an improperly crimped or damaged fitting.

19

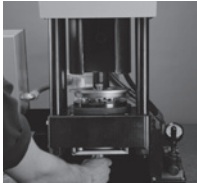

Insert hose and fitting from bottom of crimper and up through die. Position fitting so bottom of fitting shell rests on die step.

20



Press ON switch to turn on pump.

NOTE

Pump on crimper should not exceed 5000 psi (35 MPa). Parker Hannifin will not accept responsibility for the operation of or provide warranty coverage for a crimper that is operated by a power unit other than equipment supplied by Parker Hannifin for the express purpose of operating the crimper.

WARNING

Keep fingers and hands away from die-pusher area. Failure to do so may result in personal injury.



While holding hose and fitting in position on die step, lower pusher by pulling valve handle forward.

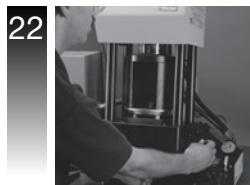

Crimp fitting onto hose until die ring contacts base plate.



Push valve handle towards the rear to retract pusher and open die set.

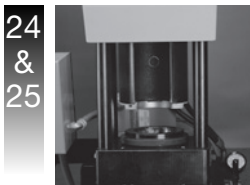

Remove hose assembly and die set.

Repeat Steps 13-24 for the other end of hose if required.



Press OFF switch to turn off pump.

Measure and inspect hose assembly

27



Measure and verify if the hose assembly length matches the work order.

28



Inspect depth insertion mark at fitting ends. Insertion mark must be visible and within 3 mm of bottom of fitting shell.

29
&
30

Measure crimp diameter of each fitting at top, middle and bottom of shell. Take measurements at a minimum of three places around shell circumference. Verify crimp diameter is within tolerances. (See Crimp Specification & Tool Selection Chart in this catalog section for proper crimp diameters.)

Pressure test hose assembly if required.

Assembly procedure – Push-Lok® self-grip hose

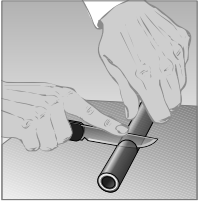

1. Cut hose perpendicularly with a sharp knife. If necessary, lubricate fitting end with water or soap and water solution (5% liquid soap + 95% water) for ease of assembly.

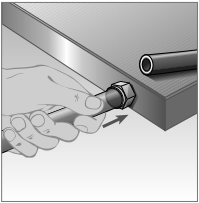

2. Insert fitting into hose and push with steady force until fitting is completely in hose. Grip hose approximately 2.5 cm from end. As an alternative, use the Parker 611050G assembly tool.

Caution! Push-Lok® fittings will provide an effective grip only when the Push-Lok® hose is pushed fully onto the insert, where the cropped end of the hose should be fully concealed by the plastic collar. Lubricate fitting end with water, soap, or a Push-Lok® assembly oil.

Disassembly

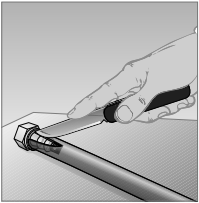

1. Cut the hose longitudinally along a line at approximately a 20° angle from the centre line of the hose. Make sure not to nick the barbs of the fitting.

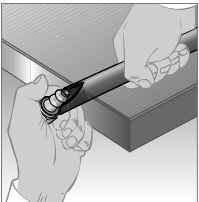

2. Pull fitting out of hose.

Caution! Before reusing the fitting, check fitting for damages. Damaged fittings result in leakage.

Push-Lok® assembly tool



For easy assembly of Parker self-gripping hose.

Overall length: approx. 320 mm

Weight: approx. 2.2 kg

Part No. 611050G

Twinline and multiline hose separation instructions

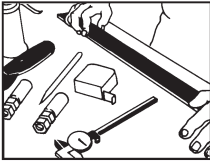

1. Position twinline or multiline hose assembly so that it lies flat on work surface without tendency to twist or turn.

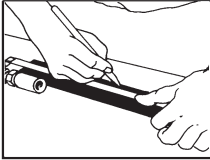

2. Measure and mark the length where the hoses are to be separated.

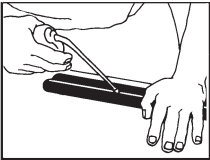

3. Lightly lubricate the area between the hoses to be separated with oil. The function of the oil is to reduce the friction of the knife blade.

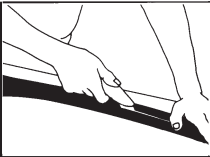

4. Press the multiline hose assembly firmly and flat against the work surface so that it does not move. Draw the knife toward you with constant light to moderate pressure and repeat cutting until hoses are separated.

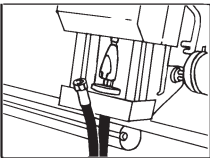

5. The separation length must be sufficiently long to avoid the risk of kinking the hoses during the crimping operation.

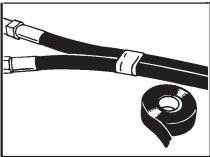

6. Depending on the requirements of the installation it is suggested that a nylon lashing strap or tape be applied at the termination of the separated length to provide protection against tearing of the hose covers.

Note:

It is important that the knife blade be perpendicular to the hose during this procedure, so that the blade cuts only the material connecting the hoses.
EXTREME CARE MUST BE TAKEN TO AVOID CUTTING THROUGH THE COVER OF THE HOSES AND THEREBY EXPOSING THE REINFORCEMENT.

Thermoplastic hose

Determining the hose length for over-the-sheaf applications

The exact cut-off length for an optimum over-the-sheaf assembly depends on the particular mechanical arrangement of the machine. A method for finding an approximate starting point is as follows:

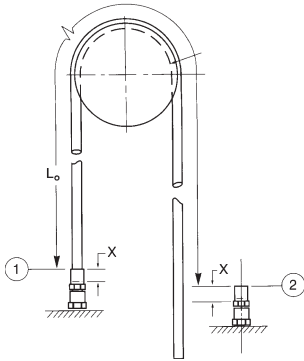

1. Assemble hose with one coupling, as shown in diagram.
2. Measure hose length from point 1 to point 2 with taut hose ($L_0 = \text{length}$)
3. Calculate the hose length:
Calculate hose cut-off or free length L_f :
$$L_f = 0.985 L_0 + 2x$$
Where L_f includes coupling insert allowance on both ends. The coupling insertion allowance (x) may be taken from the fitting tables as well as from the related drawing (difference measurement A-B) or from direct measuring on the coupling. A 1.5% stretch allowance is provided in this formula.
4. Couple the remaining hose end and assemble on the machine.

Definition of nominal length

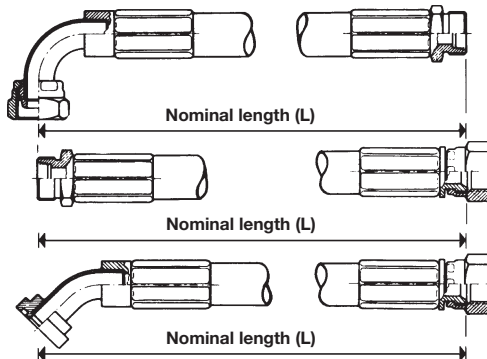

Selection, installation, and maintenance of *polyflex*[®]/*Parflex*[®] hose and hose assemblies

Hose and hose assemblies have a finite life span and many factors can reduce this time. This recommended practice should be read by designers and users of hose to assist them in the proper selection of hose. These guidelines, while not exhaustive, will assist the user in maintaining hydraulic and pneumatic systems.

READ THE PARKER SAFETY GUIDE CONTAINED IN THIS CATALOGUE IN ITS ENTIRETY!

Part 1 - How to select hose

- **Pressure** - Maximum operating pressure of the hose must be greater than or equal to the system pressure. Pressure surges or system “spikes” in excess of the maximum operating pressure will shorten hose life and must be avoided.
- **Temperature** - Ambient and fluid temperatures must not exceed the hose/fittings rated design temperature. Also the rated ambient temperature of the fluid inside the hose must not be exceeded. Attempt to route hose or shield hose from high temperature sources.
- **Size** - Adequately size hose and fittings to avoid damaging hose with excessive turbulence, or heat build-up, while maintaining proper flow and pressure. (Refer to fluid velocity nomogram.)
- **Fluid Resistance** - Refer to Chemical Resistance Guide in this catalogue for use of fluids with various materials. If unsure of an application, contact Parker *polyflex*[®].
- **Environment** - Conditions such as ozone, UV light, harsh chemicals, salt water, and other airborne contaminants can degrade hose and shorten its life.
- **Length** - Hose length changes with pressure. This, along with equipment movement, must be considered in the system design.
- **Proper couplings** - Always follow manufacturers specifications and do not mix components of different manufacturers.
- **Mechanical loads** - Conditions such as tensile and side loads, vibration, excessive flexing, and twist will reduce hose life. Use swivel fittings and adaptors to avoid hose twisting. Test the hose if the application is potentially problematic or unusual.

Part 2 – Installation and maintenance

- **Inspect components** - Check hose for cover cracks, blisters, cleanliness, kinks, cracks or core tube obstructions or other defects. Examine fittings for poor threads, obstructions, cracks, rust. Do not use hose or fittings if these problems exist.
- **Assemble per instructions contained in this catalogue.**
- **Do not exceed specified minimum bend radius** - Use stress relievers to prevent sharp bends at the hose and fitting juncture. These can be spring guards or other stress relieving members.
- **After installation, eliminate air entrapped in system, pressure to maximum operating pressure, and check for leaks and proper system function.**
- **After installation, periodically (frequency depends on severity of application and potential risk) inspect the system for the following:**
 1. Blistered, degraded, or loose hose covers.
 2. Stiff, cracked, or charred hose.
 3. Cuts or abrasion of hose. Look for exposed reinforcement.
 4. Leaks in hose or fittings.
 5. Damaged or corroded fittings.
 6. Excessive build up of dirt, grease, oils, etc.
 7. Defective or broken accessories (clamping devices, kink guards)
 8. Kinks in hoses.Upon discovery of any of these items, replace it.
DO NOT IGNORE IT!
- **Retest the system after all maintenance procedures.**
- **Establish replacement schedules based on previous service life, or when failures could result in damage, personal injury, excessive or unacceptable downtime.**

Installation standards

Hose installation tips

Establish hose size (ID) and style based upon flow rate (l/min), pressure drop, and chemical resistance with liquid or gaseous fluid. Other significant factors to be considered in hose selection and installation are the following:

Burst pressure and working pressure

The specified burst pressure for each hose style and dash size are for unaged hoses tested at normal laboratory temperature in accordance with SAE J343 specification for normal service and technically ideal installations. The maximum recommended working pressure is 1/4 of the minimum rated burst pressure, except as otherwise specifically stated in those product specifications. For more severe service, a higher rated working pressure hose may have to be selected.

Operating temperature

The temperature range for satisfactory service (maximum hose life) depends to a great extent upon the fluid being conveyed. Use of a hose above maximum specified temperature ratings will shorten hose life due, but not limited, to oxidation, chemical degradation and loss of compression within the coupling.

Pressure effects

Pressure surges and system shocks (spikes) are common in hydraulic systems. The normal 1:4 safety factor should reflect these transient pressures. Where these surges and shocks are considered severe or hazardous, the safety factor should be increased. When hose is under pressure, it may change in length by as much as +2/ -4%. Installation should compensate for shortening by providing an appropriate amount of slack and for lengthening by allowing space for this growth to be absorbed.

Bend radius

The minimum bend radii listed in this catalogue are valid at rated working pressures and indicated service temperatures. Service life of a hose may be shortened if the minimum radius is exceeded or if the hose is flexed continuously in use.

Ambient temperature

Exceedingly high or low ambient temperatures will affect the materials from which the hose is constructed and will negatively influence hose life. When at all possible, the hose should be routed in such a manner as to protect it from heat sources. In extreme cold applications, the equipment should be designed with remote relief valves to allow circulation and warming of the oil before hose articulation is attempted.

Abrasion

Abrasion occurs in numerous forms. Among the more common are the typical rubbing or chafing, with the second being very high frequency, low amplitude friction. This type of abrasion results from pump pressure pulses depending on the pump characteristics. It can also be caused by equipment vibration or resonance. Abrasion may occur when two hose lines cross or when a hose line rubs or bears against a fixed point. Abrasion resistance is also a function of temperature and attack of the cover material by aggressive chemicals.

Protective sleeving can ward off premature hose failure resulting from abrasion.

Routing and clamping

Maximum efforts should be made to route hose so it flexes in a single plane. Routing hoses in flexure through compound bends results in torsion. When this is unavoidable, the torsion should be distributed over the maximum hose length possible. Wire reinforced hoses suffer the most rapid and severe loss of service life when applied in torsion. Extremely tight and improperly located clamps focus this torsion over short distances.

Analysis of the hose function is required before the proper clamping techniques can be selected. In some applications, hoses must be contained to stay out of harm's way and at the same time be free to come and go with equipment articulation. Other applications may require restrictive clamping, in which case a protective material should be used around the hose to provide the grasp without deformation of the hose by the clamp.

Installation tips

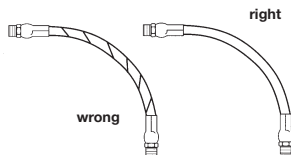

right Hose is weakened when installed in twisted position. Also, pressure pulses in twisted hose tend to fatigue wire and loosen fitting connections. Design so that machine motion produces bending rather than torsion.

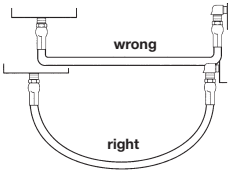

Hose should exit coupling in a straight position rather than side loaded. The minimum bend radius must not be exceeded to avoid kinking of hose and flow restriction.

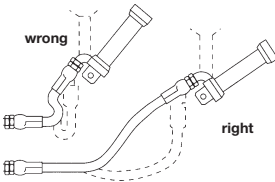

When hose assembly is installed in a flexing application, remember that metal hose fittings are not part of the flexible portion.

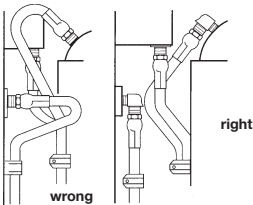

Use elbows or adaptors as necessary to eliminate excess hose length and to ensure neater installation and easier maintenance.

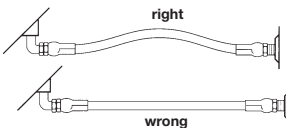

right Free hose length allowance:

Pressure can change hose in length by as much as $\pm 2\%$. This must be considered when cutting hose to appropriate length.

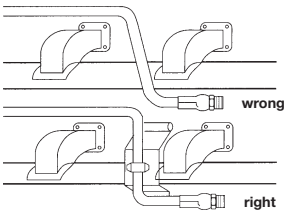

Avoid installing hose assemblies close to heat sources. However, if this should be required, insulate hose.

Parker safety guide for selecting and using hose, fittings and related accessories

! DANGER: Failure or improper selection or improper use of hose, fittings, or related accessories can cause death, personal injury and property damage. Possible consequences of failure or improper selection or improper use of hose, fittings, or related accessories include but are not limited to:

- Fittings thrown off at high speed
- High velocity fluid discharge
- Explosion or burning of the conveyed fluid
- Electrocutation from high voltage electric power lines or other sources of electricity
- Contact with suddenly moving or falling objects that are to be held in position or moved by the conveyed fluid
- Dangerously whipping hose
- Contact with conveyed fluids that may be hot, cold, toxic or otherwise injurious
- Sparking or explosion caused by static electricity build-up
- Sparking or explosion while paint or flammable liquid spraying

Before selecting or using any Parker hose or fittings or related accessories, it is important that you read and follow the following instructions.

1.0 General hints

1.1 Scope:

This safety guide provides instructions for selecting and using (including assembling, installing, and maintaining) hose (including all rubber and/or plastic products commonly called hose or tubing), fittings (including all products commonly called fittings or couplings for attachment to hose), and related accessories (including crimping and swaging machines and tooling). This safety guide is a supplement to and is to be used with, specific Parker publications for the specific hose, fittings and related accessories that are being considered for use.

1.2 Fail safe:

Hose and hose assemblies can and do fail without warning for many reasons. Design all systems and equipment in a fail-safe mode, so that failure of the hose or hose assembly will not endanger persons or property.

1.3 Distribution:

Provide a copy of this safety guide to each person that is responsible for selecting or using hose and fitting products. Do not select or use hose and fittings without thoroughly reading and understanding this safety guide as well as the specific Parker publications for the products considered or selected.

- 1.4 User responsibility:** Due to the wide variety of operating conditions and uses for hose and fittings, Parker and its distributors do not represent or warrant that any particular hose or fitting is suitable for any specific end use system. This safety guide does not analyse all technical parameters that must be considered in selecting a product. The user, through his own analysis and testing, is solely responsible for:
- Making the final selection of the hose and fitting
 - Assuring that the user's requirements are met and that the use presents no health or safety hazards
 - Providing all appropriate health and safety warnings on the equipment on which the hose and fittings are used
- 1.5 Additional questions:** Call the appropriate Parker technical service department if you have any questions or require any additional information. See the Parker publication for the product being considered or used, for telephone numbers of the appropriate technical service department.

2.0 Hose and fitting selection instructions

- 2.1 Electrical conductivity:** Certain applications require that a hose be non-conductive to prevent electrical current flow. Other applications require the hose to be sufficiently conductive to drain off static electricity. Extreme care must be exercised when selecting hose and fittings for these or any other applications in which electrical conductivity or non-conductivity is a factor. For applications that require hose to be electrically non-conductive, including but not limited to applications near high voltage electric lines, only special non-conductive hose can be used. The manufacturer of the equipment in which the non-conductive hose is to be used must be consulted to be certain that the hose and fittings selected are proper for the application. Do not use any Parker hose or fitting for any such application requiring non-conductive hose, including but not limited to applications near high voltage electric lines, unless (1) the application is expressly approved in the Parker technical publication for the product, (2) the hose is both orange colour and marked non-conductive, and (3) the manufacturer of the equipment on which the hose is to be used specifically approves the particular Parker hose and fitting for such use.
- The electrical conductivity or non-conductivity of hose and fittings is dependent upon many factors and may be susceptible to change. These factors include but are not limited to the various materials used to make the hose and the fittings' manufacturing methods (including moisture control), how the fittings contact the hose, age and amount of deterioration or damage or other changes, moisture content of the hose at any particular time and other factors.
- Parker manufactures a special hose for conveying paint in airless paint spraying applications. This hose is labelled Electrically Conductive Airless Paint Spray Hose on its layline and on its packag-

ing. This hose must be properly connected to Parker fittings and properly grounded in order to dissipate dangerous static charge build-up which occurs in all airless paint spraying. Do not use any other hose, even if electrically conductive, for airless paint spraying. Use of any other hose or failure to properly connect the hose can cause a fire or an explosion resulting in death, personal injury, and property damage.

Parker manufactures a special hose for certain compressed natural gas (CNG) applications where static electricity build-up may occur. This hose is labelled Electrically Conductive for CNG Use on its layline and on its packaging. This hose must be properly connected to Parker fittings and properly grounded in order to dissipate dangerous static charge build-up which occurs in, for example, high velocity CNG dispensing or transfer. Do not use any other hose, even if electrically conductive, for CNG transfer where static charge build-up may occur. Use of any other hose in such application or failure to properly connect this hose can cause a fire or an explosion resulting in death, personal injury, and property damage. Care must also be taken to protect against dangerous gas permeation through the hose wall. See section 2.6, Permeation of Fluids, for more information.

2.2 Pressure:

Hose selection must be made so that the published maximum recommended working pressure of the hose is equal to or greater than the maximum system pressure. Surge pressures in the system higher than the published maximum recommended working pressure will cause failure or shorten hose life. Do not confuse burst pressure or other pressure values for this purpose.

2.3 Suction:

Hoses used for suction applications must be selected to insure that the hose will withstand the vacuum and pressure of the system. Improperly selected hose may collapse in suction applications.

2.4 Temperature:

Be certain that fluid and ambient temperatures, both steady and transient, do not exceed the limitations of the hose. Care must be taken when routing hose near hot objects such as manifolds.

2.5 Fluid resistance:

Hose selection must assure resistance of the hose tube, cover, reinforcement, and fittings with the fluid media used. See the fluid resistance chart in the Parker publication for the product being considered or used.

2.6 Permeation:

Permeation (that is seepage through the hose) will occur from inside the hose to outside when hose is used with gases, liquid and gas fuels, and refrigerants (including but not limited to such materials as helium, fuel oil, natural gas, or Freon®*). This permeation may result in high concentrations of vapours which are potentially flammable, explosive, or toxic, and in loss of fluid. Dangerous explosions, fires, and other hazards can result when using the wrong hose for such applications. The system designer must take into account the fact that this permeation will take place and must not use hose if this permeation could be hazardous. The system designer must take into account all legal, government, insurance, or any other special regulations which govern the use of fuels and refrigerants. Never use a hose even though its fluid resistance is acceptable without considering the potential hazardous effects that can result from permeation through the hose assembly.

Permeation of moisture from outside the hose to inside the hose will also occur in hose assemblies, regardless of internal pressure. If this moisture permeation would have detrimental effects (particularly but not limited to refrigeration and air conditioning systems), incorporation of sufficient drying capacity in the system or other appropriate system safeguards should be selected and used.

* Freon® is a registered trademark of the E. I. DuPont De Nemours Co. Inc.

2.7 Size:

Transmission of power by means of pressurised fluid varies with pressure and rate of flow. The size of the components must be adequate to keep pressure losses to a minimum and avoid damage due to heat generation or excessive fluid velocity.

2.8 Routing:

Attention must be given to optimum routing to minimise inherent problems (kinking or flow restriction due to hose collapse).

2.9 Environment:

Care must be taken to ensure that the hose and fittings are either compatible with or protected from the environment (that is, surrounding conditions) to which they are exposed. Environmental conditions, including but not limited to ultraviolet radiation, sunlight, heat, ozone, moisture, water, salt water, chemicals, and air pollutants, can cause degradation and premature failure.

- 2.10 Mechanical loads:** External forces can significantly reduce hose life or cause failure. Mechanical loads which must be considered include excessive flexing, twisting, kinking, tensile or side loads, bend radius, and vibration. Use of swivel type fittings or adaptors may be required to ensure no twist is put into the hose. Unusual applications may require special testing prior to hose selection.
- 2.11 Physical damage:** Care must be taken to protect hose from wear, snagging and cutting, which can cause premature hose failure.
- 2.12 Proper end fitting:** See instruction 3.2 to 3.5. These recommendations may be substantiated by testing to industry standards such as SAE J517.
- 2.13 Length:** When establishing a proper hose length, motion absorption, hose length changes due to pressure, and hose and machine tolerances must be considered.
- 2.14 Specifications and standards:** When selecting hose and fittings, government, industry, and Parker specifications and recommendations must be reviewed and followed as applicable.
- 2.15 Hose cleanliness:** Hose components may vary in cleanliness levels. Care must be taken to ensure that the assembly selected has an adequate level of cleanliness for the application.
- 2.16 Fire resistant fluids:** Some fire resistant fluids require the same hose as petroleum oil. Some use a special hose, while a few fluids will not work with any hose at all. See instructions 2.5 and 1.5. The wrong hose may fail after a very short service. In addition, all liquids but pure water may burn fiercely under certain conditions, and even pure water leakage may be hazardous.
- 2.17 Radiant heat:** Hose can be heated to destruction without contact by such nearby items as hot manifolds or molten metal. The same heat source may then initiate a fire. This can occur despite the presence of cool air around the hose.
- 2.18 Welding and brazing:** When using a torch or arc welder in close proximity to hydraulic lines, the hydraulic lines should be removed or shielded with appropriate fire resistant materials. Flame or weld spatter could burn through the hose and possibly ignite escaping fluid resulting in a catastrophic failure. Heating of plated parts, including hose fittings and adaptors, above 232 °C) such as during welding, brazing, or soldering may emit deadly gases.
- 2.19 Atomic radiation:** Atomic radiation affects all materials used in hose assemblies. Since the long-term effects may be unknown, do not expose hose assemblies to atomic radiation.

3.0 Hose and fitting assembly and installation instructions

3.1 Pre-installation inspection:

Prior to installation, a careful examination of the hose must be performed. All components must be checked for correct style, size, catalogue number and length. In addition, the hose must be examined for cleanliness, obstructions, blisters, cover looseness, or any other visible defects.

3.2 Hose and fitting assembly:

Do not assemble a Parker fitting on a Parker hose that is not specifically listed by Parker for that fitting unless authorised in writing by the chief engineer of the appropriate Parker division. Do not assemble a Parker fitting on another manufacturer's hose or a Parker hose on another manufacturer's fitting unless (1) the chief engineer of the appropriate Parker division approves the assembly in writing, and (2) the user verifies the assembly and the application through analysis and testing. See instruction 1.4.

The Parker published instructions must be followed for assembling the fittings on the hose. These instructions are provided in the Parker Fitting Catalogue for the specific Parker fitting being used.

3.3 Related accessories:

Do not crimp or swage any Parker hose or fitting with anything but the proper listed Parker swage or crimp machine and dies and in accordance with Parker published instructions. Do not crimp or swage another manufacturer's hose fitting with a Parker crimp or swage die unless authorised in writing by the chief engineer of the appropriate Parker division.

3.4 Parts:

Do not use any Parker hose fitting part (including but not limited to socket and nipple) except with the correct Parker mating parts, in accordance with Parker published instructions, unless authorised in writing by the chief engineer of the appropriate Parker division.

3.5 Reusable fittings:

Do not reuse any reusable hose fitting that was blown or pulled off a hose. Do not reuse a Parker permanent hose fitting (that is, crimped or swaged) or any part thereof.

3.6 Minimum bend radius:

Installation of a hose at less than the minimum listed bend radius may significantly reduce the hose life. Particular attention must be given to preclude sharp bending at the hose/fitting juncture.

3.7 Twist angle and orientation:

Hose installations must be such that relative motion of machine components does not produce twisting.

- 3.8 Securement:** In many applications, it may be necessary to restrain, protect, or guide the hose to protect it from damage by unnecessary flexing, pressure surges, and contact with other mechanical components. Care must be taken to ensure such restraints do not introduce additional stress or wear points.
- 3.9 Proper connection of ports:** Proper physical installation of the hose requires a correctly installed port connection while ensuring that no twist or torque is transferred to the hose.
- 3.10 External damage:** Proper installation is not complete without ensuring that tensile loads, side loads, kinking, flattening, potential abrasion, thread damage, or damage to sealing surfaces are corrected or eliminated. See instruction 2.10.
- 3.11 System checkout:** All air entrapment must be eliminated and the system pressurised to the maximum system pressure and checked for proper function and freedom from leaks. Personnel must stay out of potential hazardous areas while testing and using.
- 3.12 Routing:** Hose should be routed in such a manner that if a failure does occur, oil mist will not come into contact with hot surfaces, open flame, or sparks, and the chance of personal injury is minimised.

4.0 Hose and fitting maintenance instructions

4.1 Maintenance programme:

Even with proper selection and installation, hose life may be significantly reduced without a continuing maintenance program. Frequency should be determined by the severity of the application and risk potential. A maintenance program must be established and followed by the user and must include the following as a minimum:

4.2 Visual inspection of hose/fitting:

Any of the following conditions require immediate shut down and replacement of the hose assembly:

- Fitting slippage on hose
- Damage, cut or abraded cover (any reinforcement exposed)
- Hard, stiff, heat cracked, or charred hose
- Cracked, damaged, or badly corroded fittings
- Leaks at fitting or in hose
- Kinked, crushed, flattened or twisted hose
- Blistered, soft, degraded, or loose cover

4.3 Visual inspection of other parts:

The following items must be tightened, repaired, removed or replaced as required:

- Leaking port conditions
- Excess dirt build-up
- Clamps, guards, shields
- System fluid level, fluid type and any air entrapment

4.4 Functional test:

Operate the system at maximum operating pressure and check for possible malfunctions and freedom from leaks. Personnel must avoid potential hazardous areas while testing and using.

4.5 Replacement intervals:

Specific replacement intervals must be considered based on previous service life, industry recommendations, or when failures could result in unacceptable downtime, damage, or injury risk. See instruction 1.2.

4.6 Inspecting a pressurised system:

Hydraulic power is accomplished by utilising high-pressure fluids to do work. Hoses, fittings and hose assemblies all contribute to doing work by transmitting fluids at high pressures. Fluids under pressure can be dangerous and potentially lethal and, therefore, extreme caution must be exercised when working with fluids under pressure and handling the hoses transporting the fluids. Usually these failures are the result of some form of misapplication, abuse, or simply wear. When hoses fail, generally the high-pressure fluids inside escape in some sort of stream which may or may not be visible to the user. High-pressure fluids can and will penetrate the skin and cause severe tissue damage and possibly loss of limb. Even seemingly minor hydraulic fluid injection injuries must be treated by a physician with knowledge of the tissue damaging properties of hydraulic fluid. If a hose failure occurs, immediately shut down the equipment and leave the area until pressure has been completely released from the hose assembly. Simply shutting down the hydraulic pump may or may not eliminate the pressure in the hose assembly. Many times check valves, etc., are employed in a system and can cause pressure to remain in a hose assembly even when pumps or equipment are not operating. Tiny holes in the hose, commonly known as pinholes, can eject small, dangerously powerful but hard to see streams of hydraulic fluid. It may take several minutes or even hours for the pressure to be relieved so that the hose assembly may be examined safely.

Once the pressure has been reduced to zero, the hose assembly may be taken off the equipment and examined. It must always be replaced if a failure has occurred. Never attempt to patch or repair a hose assembly that has failed. Consult the nearest Parker distributor or the appropriate Parker division for hose assembly replacement information.

Never touch or examine a failed hose assembly unless it is obvious that the hose no longer contains fluid under pressure. The high-pressure fluid is extremely dangerous and can cause serious and potentially fatal injury.

4.7 Refrigerant gases:

Special care should be taken when working with refrigeration systems. Sudden escape of refrigerant gases can cause blindness if the escaping gases contact the eye and can cause freezing or other severe injuries if it contacts any other part of the body.

For Your Safety!

Hose assemblies are used to transmit various kinds of fluids at considerable pressures. The critical zone of a hose assembly is the connection between flexible hose and rigid fitting (crimping area). Only the use of original **polyflex**[®] components (hose, fittings and tooling) and full compliance with the **polyflex**[®] assembly instructions can guarantee safety and conformity with standards.

When making and testing hose assemblies in connection with the respective field of application the guidelines and technical regulations as well as protection and hazard prevention rulings must be adhered to.

You as the manufacturer of **polyflex**[®] hose assemblies are obliged to mark the hose assemblies according to the regulations.

Non-compliance with these rules can lead to the failure of a hose assembly and the loss of warranty.

Unit Conversion Table

Physical value	Unit	Abbreviation	Conversion Unit	Factor
Length	1 inch	in	mm	25.4
	1 millimetre	mm	in	0.03934
	1 foot	ft	m	0.3048
	1 metre	m	ft	3.28084
Surface	1 square inch	sq in	cm ²	6.4516
	1 square centimetre	cm ²	sq in	0.1550
Cubic content	1 gallon (UK)	gal	l	4.54596
	1 litre	l	gal (UK)	0.219976
	1 gallon (US)	gal	l	3.78533
	1 litre	l	gal (US)	0.264177
Weight	1 pound	lb	kg	0.453592
	1 kilogramme	kg	lb	2.204622
Pressure	1 pound per square inch	psi	bar	0.06895
	1 bar	bar	psi	14.5035
	1 pound per square inch	psi	MPa	0.006895
	1 mega pascal	MPa	psi	145.035
	1 kilo pascal	kPa	bar	0.01
	1 bar	bar	kPa	100
	1 mega pascal	MPa	bar	10
	1 bar	bar	MPa	0.1
Velocity	1 foot per second	ft/s	m/s	0.3048
	1 metre per second	m/s	ft/s	3.28084
Flow rate	1 gallon per minute (UK)	gal/min.	l/min.	4.54596
	1 litre per minute	l/min.	gal/min. (UK)	0.219976
	1 gallon per minute (US)	gal/min.	l/min.	3.78533
	1 litre per minute	l/min.	gal/min. (US)	0.264178
Temperature	Fahrenheit	F	°C	$\frac{5}{9} (F-32)$
	Celsius	°C	F	$\frac{9}{5} °C + 32$

Chapter I

Index of part numbers

Part No.	Page	Part No.	Page	Part No.	Page
10155-12-12.....	E-61	101EX-2-025.....	E-101	101YX-8-08.....	C-52
10155-16-16.....	E-61	101EX-4-012.....	E-101	10293N-12-12.....	C-30
10155-2-3.....	E-61	101EX-4-025.....	E-101	10293N-16-16.....	C-30
10155-2-4.....	E-61	101NX-12-10.....	E-109	10293N-20-20.....	C-30
10155-4-3.....	E-61	101NX-12-12.....	E-109	10293N-24-24.....	C-30
10155-4-4.....	E-61	101NX-16-12.....	E-109	10293N-32-32.....	C-30
10155-4-5.....	E-61	101NX-16-16.....	E-109	10293N-8-8.....	C-30
10155-4-6.....	E-61	101NX-20-16.....	E-109	10355-10-8.....	E-62
10155-6-3.....	E-61	101NX-4-04.....	E-109	10355-12-12.....	E-62
10155-6-4.....	E-61	101NX-6-05.....	E-109	10355-16-16.....	E-62
10155-6-5.....	E-61	101NX-6-06.....	E-109	10355-4-3.....	E-62
10155-6-6.....	E-61	101NX-8-06.....	E-109	10355-4-4.....	E-62
10155-6-8.....	E-61	101NX-8-08.....	E-109	10355-5-4.....	E-62
10155-8-6.....	E-61	101PC-12-10.....	C-42	10355-5-5.....	E-62
10155-8-8.....	E-61	101PC-12-12.....	C-42	10355-6-4.....	E-62
10157-2-2.....	E-80	101PC-16-12.....	C-42	10355-6-5.....	E-62
10158-12-12.....	E-87	101PC-16-16.....	C-42	10355-6-6.....	E-62
10158-16-16.....	E-87	101PC-4-04.....	C-42	10355-8-6.....	E-62
10158-2-3.....	E-87	101PC-4-06.....	C-42	10355-8-8.....	E-62
10158-2-4.....	E-87	101PC-6-04.....	C-42	103NX-10-08.....	E-110
10158-4-3.....	E-87	101PC-6-05.....	C-42	103NX-12-10.....	E-110
10158-4-4.....	E-87	101PC-6-06.....	C-42	103NX-16-12.....	E-110
10158-4-5.....	E-87	101PC-6-08.....	C-42	103NX-20-16.....	E-110
10158-4-6.....	E-87	101PC-8-06.....	C-42	103NX-24-20.....	E-110
10158-6-3.....	E-87	101PC-8-08.....	C-42	103NX-5-04.....	E-110
10158-6-4.....	E-87	101PX-12-10.....	E-126	103NX-6-05.....	E-110
10158-6-5.....	E-87	101PX-12-12.....	E-126	103NX-8-06.....	E-110
10158-6-6.....	E-87	101PX-16-12.....	E-126	103PC-10-08.....	C-42
10158-6-8.....	E-87	101PX-16-16.....	E-126	103PC-12-10.....	C-42
10158-8-6.....	E-87	101PX-2-03.....	E-126	103PC-16-12.....	C-42
10158-8-8.....	E-87	101PX-4-03.....	E-126	103PC-20-16.....	C-42
10191N-12-12.....	C-18	101PX-4-04.....	E-126	103PC-5-04.....	C-42
10191N-16-16.....	C-18	101PX-4-06.....	E-126	103PC-6-04.....	C-42
10191N-2-4.....	C-18	101PX-6-04.....	E-126	103PC-6-05.....	C-42
10191N-20-20.....	C-18	101PX-6-05.....	E-126	103PC-8-06.....	C-42
10191N-4-4.....	C-18	101PX-6-06.....	E-126	103PX-10-08.....	E-126
10191N-4-5.....	C-18	101PX-6-08.....	E-126	103PX-12-10.....	E-126
10191N-4-6.....	C-18	101PX-8-06.....	E-126	103PX-16-12.....	E-126
10191N-4-8.....	C-18	101PX-8-08.....	E-126	103PX-20-16.....	E-126
10191N-6-6.....	C-18	101YX-12-10.....	C-52	103PX-4-03.....	E-126
10191N-6-8.....	C-18	101YX-12-12.....	C-52	103PX-5-04.....	E-126
10191N-8-10.....	C-18	101YX-16-12.....	C-52	103PX-6-04.....	E-126
10191N-8-12.....	C-18	101YX-16-16.....	C-52	103PX-6-05.....	E-126
10191N-8-8.....	C-18	101YX-2-03.....	C-52	103PX-8-06.....	E-126
10193N-12-12.....	C-30	101YX-4-03.....	C-52	103YX-10-08.....	C-52
10193N-16-16.....	C-30	101YX-4-04.....	C-52	103YX-12-10.....	C-52
10193N-20-20.....	C-30	101YX-4-06.....	C-52	103YX-16-12.....	C-52
10193N-24-24.....	C-30	101YX-6-04.....	C-52	103YX-20-16.....	C-52
10193N-32-32.....	C-30	101YX-6-05.....	C-52	103YX-4-03.....	C-52
10193N-8-10.....	C-30	101YX-6-06.....	C-52	103YX-5-04.....	C-52
10193N-8-8.....	C-30	101YX-6-08.....	C-52	103YX-6-05.....	C-52

Index of part numbers

Part No.	Page	Part No.	Page	Part No.	Page
103YX-8-06	C-52	10691N-16-16	C-19	106YX-16-12	C-53
10555-10-8	E-62	10691N-16-16-RD	C-19	106YX-20-16	C-53
10555-4-3	E-62	10691N-20-20	C-19	106YX-4-03	C-53
10555-4-4	E-62	10691N-4-4	C-19	106YX-5-04	C-53
10555-4-5	E-62	10691N-4-4-RD	C-19	106YX-6-05	C-53
10555-5-4	E-62	10691N-5-5	C-19	106YX-8-06	C-53
10555-5-5	E-62	10691N-5-5-RD	C-19	10791N-12-12	C-20
10555-6-4	E-62	10691N-6-6	C-19	10791N-16-16	C-20
10555-6-6	E-62	10691N-6-6-RD	C-19	10791N-4-4	C-20
10555-8-6	E-62	10691N-8-8	C-19	10791N-6-6	C-20
10555-8-8	E-62	10691N-8-8-RD	C-19	10791N-8-8	C-20
10655-10-8	E-63	10693N-10-10	C-31	107NX-12-10	E-111
10655-12-12	E-63	10693N-12-12	C-31	107NX-12-12	E-111
10655-12-8	E-63	10693N-16-16	C-31	107NX-4-04	E-111
10655-16-16	E-63	10693N-20-20	C-31	107NX-6-05	E-111
10655-4-2	E-63	10693N-24-24	C-31	107NX-6-06	E-111
10655-4-3	E-63	10693N-32-32	C-31	107NX-8-08	E-111
10655-4-4	E-63	10693N-8-8	C-31	107PC-12-10	C-43
10655-5-3	E-63	1069X-10-08	E-95	107PC-12-12	C-43
10655-5-4	E-63	1069X-6-06	E-95	107PC-2-03	C-43
10655-5-5	E-63	1069X-8-06	E-95	107PC-4-03	C-43
10655-6-4	E-63	106EX-3-012	E-102	107PC-4-04	C-43
10655-6-5	E-63	106EX-4-012	E-102	107PC-6-05	C-43
10655-6-6	E-63	106NX-10-08	E-110	107PC-6-06	C-43
10655-6-8	E-63	106NX-10-10	E-110	107PC-8-08	C-43
10655-8-5	E-63	106NX-12-10	E-110	107PX-12-10	E-127
10655-8-6	E-63	106NX-12-12	E-110	107PX-12-12	E-127
10655-8-8	E-63	106NX-16-12	E-110	107PX-2-03	E-127
10656-4-3	E-77	106NX-16-16	E-110	107PX-4-02	E-127
10656-4-4	E-77	106NX-20-16	E-110	107PX-4-03	E-127
10656-5-4	E-77	106NX-5-04	E-110	107PX-4-04	E-127
10656-6-4	E-77	106NX-6-05	E-110	107PX-6-05	E-127
10656-6-5	E-77	106NX-6-06	E-110	107PX-6-06	E-127
10656-6-6	E-77	106NX-8-06	E-110	107PX-8-08	E-127
10656-8-6	E-77	106NX-8-08	E-110	107YX-12-10	C-53
10656-8-8	E-77	106PC-10-08	C-43	107YX-12-12	C-53
10657-4-2	E-80	106PC-12-10	C-43	107YX-2-03	C-53
10658-10-8	E-88	106PC-16-12	C-43	107YX-4-03	C-53
10658-12-12	E-88	106PC-20-16	C-43	107YX-4-04	C-53
10658-12-8	E-88	106PC-4-04	C-43	107YX-6-05	C-53
10658-16-12	E-88	106PC-5-04	C-43	107YX-6-06	C-53
10658-16-16	E-88	106PC-6-05	C-43	107YX-8-08	C-53
10658-4-3	E-88	106PC-6-06	C-43	10891N-12-12	C-22
10658-4-4	E-88	106PC-8-06	C-43	10891N-6-6	C-22
10658-5-3	E-88	106PX-10-08	E-127	108JJ-8-8C	D-3
10658-5-4	E-88	106PX-12-10	E-127	10C56-10-4	E-71
10658-5-5	E-88	106PX-16-12	E-127	10C56-12-5	E-71
10658-6-4	E-88	106PX-20-16	E-127	10C56-12-6	E-71
10658-6-5	E-88	106PX-4-02	E-127	10C56-16-8	E-71
10658-6-6	E-88	106PX-4-03	E-127	10C56-8-3	E-71
10658-6-8	E-88	106PX-4-04	E-127	10C58-16-8	E-83
10658-8-6	E-88	106PX-5-04	E-127	10C58-8-3	E-83
10658-8-8	E-88	106PX-6-05	E-127	10C9X-14-06	E-93
10691N-10-10	C-19	106PX-6-06	E-127	10C9X-16-08	E-93
10691N-10-10-RD	C-19	106PX-8-06	E-127	10CNX-10-04	E-106
10691N-12-12	C-19	106YX-10-08	C-53	10CNX-12-05	E-106
10691N-12-12-RD	C-19	106YX-12-10	C-53	10CNX-12-06	E-106

Index



Part No.	Page	Part No.	Page	Part No.	Page
10CNX-14-06	E-106	11CPX-20-10	E-118	11DYX-10-05	C-48
10CNX-16-08	E-106	11CPX-6-04	E-118	11DYX-10-06	C-48
10CNX-20-10	E-106	11CPX-8-03	E-118	11DYX-12-06	C-48
10CNX-25-12	E-106	11D54-12-6	E-51	11DYX-15-08	C-48
10CNX-30-16	E-106	11D54-6-4	E-51	11DYX-18-10	C-48
10CPC-10-04	C-35	11D54-8-4	E-51	11DYX-22-12	C-48
10CPC-12-05	C-35	11D55-10-5	E-58	11DYX-28-16	C-48
10CPC-14-06	C-35	11D55-12-6	E-58	11DYX-6-03	C-48
10CPC-16-08	C-35	11D55-15-8	E-58	11DYX-8-04	C-48
10CPC-20-10	C-35	11D55-22-12	E-58	1202LT-3	E-12
10CPX-10-04	E-117	11D55-6-3	E-58	1202LT-4	E-12
10CPX-12-05	E-117	11D55-8-4	E-58	1202LT-5	E-12
10CPX-14-06	E-117	11D56-10-5	E-74	1202LT-6	E-12
10CPX-16-08	E-117	11D56-10-6	E-74	1202LT-8	E-12
10CPX-20-10	E-117	11D56-12-6	E-74	12891N-10-10	C-23
10CPX-8-03	E-117	11D56-15-8	E-74	12891N-12-12	C-23
115NX-12-10	E-111	11D56-18-12	E-74	12891N-4-4	C-23
115NX-12-12	E-111	11D56-18-8	E-74	12891N-5-5	C-23
115NX-16-16	E-111	11D56-22-12	E-74	12891N-5-6	C-23
115NX-20-20	E-111	11D56-28-16	E-74	12891N-6-6	C-23
115NX-8-08	E-111	11D56-6-3	E-74	12891N-8-8	C-23
117NX-12-10	E-112	11D56-6-4	E-74	128PX-4-03-LPG	D-7
117NX-12-12	E-112	11D56-8-4	E-74	13755-10-8-SM	E-64
117NX-16-16	E-112	11D91N-10-6	C-15	13755-12-12-SM	E-64
117NX-20-20	E-112	11D91N-10-8	C-15	13755-16-16-SM	E-64
117NX-8-08	E-112	11D91N-12-10	C-15	13755-4-3-SM	E-64
119NX-12-10	E-112	11D91N-12-8	C-15	13755-4-4-SM	E-64
119NX-12-12	E-112	11D91N-15-10	C-15	13755-5-4-SM	E-64
119NX-16-16	E-112	11D91N-18-10	C-15	13755-6-5-SM	E-64
119NX-20-20	E-112	11D91N-18-12	C-15	13755-6-6-SM	E-64
119NX-8-08	E-112	11D91N-22-16	C-15	13755-8-6-SM	E-64
11C56-10-4	E-72	11D91N-28-20	C-15	13755-8-8-SM	E-64
11C56-12-5	E-72	11D91N-6-4	C-15	13791N-10-10	C-20
11C56-12-6	E-72	11D91N-6-5	C-15	13791N-12-12	C-20
11C56-16-8	E-72	11D91N-8-5	C-15	13791N-16-16	C-20
11C58-12-5	E-84	11D91N-8-6	C-15	13791N-20-20	C-20
11C58-12-6	E-84	11DEX-4-012	E-99	13791N-4-4	C-20
11C58-16-8	E-84	11DEX-4-025	E-99	13791N-5-5	C-20
11C9X-14-06	E-93	11DEX-6-025	E-99	13791N-6-6	C-20
11C9X-16-08	E-93	11DPC-10-05	C-38	13791N-8-8	C-20
11CNX-10-04	E-107	11DPC-10-06	C-38	137PC-10-08	C-44
11CNX-12-05	E-107	11DPC-12-06	C-38	137PC-12-10	C-44
11CNX-14-06	E-107	11DPC-15-08	C-38	137PC-16-12	C-44
11CNX-16-08	E-107	11DPC-18-10	C-38	137PC-20-16	C-44
11CNX-20-10	E-107	11DPC-22-12	C-38	137PC-5-04	C-44
11CNX-25-12	E-107	11DPC-28-16	C-38	137PC-6-05	C-44
11CNX-30-16	E-107	11DPC-8-04	C-38	137PX-10-08	E-128
11CPC-10-04	C-36	11DPX-10-05	E-120	137PX-12-10	E-128
11CPC-12-05	C-36	11DPX-10-06	E-120	137PX-16-12	E-128
11CPC-14-06	C-36	11DPX-12-06	E-120	137PX-20-16	E-128
11CPC-16-08	C-36	11DPX-15-08	E-120	137PX-4-03	E-128
11CPC-20-10	C-36	11DPX-18-10	E-120	137PX-5-04	E-128
11CPC-6-04	C-36	11DPX-22-12	E-120	137PX-6-05	E-128
11CPX-10-04	E-118	11DPX-28-16	E-120	137PX-8-06	E-128
11CPX-12-05	E-118	11DPX-6-03	E-120	137YX-10-08	C-54
11CPX-14-06	E-118	11DPX-8-04	E-120	137YX-12-10	C-54
11CPX-16-08	E-118	11DPX-8-04-LPG	D-7	137YX-16-12	C-54

Part No.	Page	Part No.	Page	Part No.	Page
137YX-20-16	C-54	13BNX-12-10	E-109	13D56-12-5	E-74
137YX-4-03	C-54	13BNX-12-12	E-109	13D56-12-6	E-74
137YX-5-04	C-54	13BNX-16-12	E-109	13D56-14-6	E-74
137YX-6-05	C-54	13BNX-16-16	E-109	13D56-16-8	E-74
137YX-8-06	C-54	13BNX-20-16	E-109	13D56-20-12	E-74
13955-10-8-SM	E-64	13BNX-20-20	E-109	13D56-25-12	E-74
13955-12-12-SM	E-64	13BNX-24-20	E-109	13D56-8-3	E-74
13955-16-16-SM	E-64	13BNX-4-04	E-109	13D56-8-4	E-74
13955-4-3-SM	E-64	13BNX-6-05	E-109	13D91N-10-5	C-16
13955-4-4-SM	E-64	13BNX-6-06	E-109	13D91N-12-6	C-16
13955-5-4-SM	E-64	13BNX-8-06	E-109	13D91N-14-8	C-16
13955-6-4-SM	E-64	13BNX-8-08	E-109	13D91N-16-10	C-16
13955-6-5-SM	E-64	13BPC-12-10	C-41	13D91N-20-12	C-16
13955-6-6-SM	E-64	13BPC-12-12	C-41	13D91N-25-16	C-16
13955-8-6-SM	E-64	13BPC-16-12	C-41	13D91N-30-16	C-16
13955-8-8-SM	E-64	13BPC-16-16	C-41	13D91N-6-3	C-16
13958-10-8-SM	E-89	13BPC-20-16	C-41	13D91N-8-4	C-16
13958-12-12-SM	E-89	13BPC-4-04	C-41	13DEX-6-012	E-99
13958-16-16-SM	E-89	13BPC-6-05	C-41	13DEX-8-012	E-99
13958-4-3-SM	E-89	13BPC-6-06	C-41	13DEX-8-025	E-99
13958-4-4-SM	E-89	13BPC-8-06	C-41	14191N-10-10	C-21
13958-5-4-SM	E-89	13BPC-8-08	C-41	14191N-12-12	C-21
13958-6-4-SM	E-89	13BPX-12-10	E-124	14191N-16-16	C-21
13958-6-5-SM	E-89	13BPX-12-12	E-124	14191N-20-20	C-21
13958-6-6-SM	E-89	13BPX-16-12	E-124	14191N-4-4	C-21
13958-8-6-SM	E-89	13BPX-16-16	E-124	14191N-5-5	C-21
13958-8-8-SM	E-89	13BPX-2-03	E-124	14191N-6-6	C-21
13991N-10-10	C-21	13BPX-20-16	E-124	14191N-8-8	C-21
13991N-12-12	C-21	13BPX-4-03	E-124	14956-10-4	E-78
13991N-16-16	C-21	13BPX-4-04	E-124	14956-12-4	E-78
13991N-4-4	C-21	13BPX-6-05	E-124	14956-12-5	E-78
13991N-5-5	C-21	13BPX-6-06	E-124	14956-12-6	E-78
13991N-6-6	C-21	13BPX-8-04BF	E-124	14956-14-3	E-78
13991N-8-8	C-21	13BPX-8-04BF2	E-125	14956-14-4	E-78
139PC-10-08	C-44	13BPX-8-04C	E-124	14956-14-5	E-78
139PC-12-10	C-44	13BPX-8-04CS	E-125	149EX-10-025	E-103
139PC-16-12	C-44	13BPX-8-06	E-124	149EX-8-02	E-103
139PC-20-16	C-44	13BPX-8-08	E-124	149PX-10-03-LPG	D-5
139PC-5-04	C-44	13BYX-12-10	C-51	149PX-10-04-LPG	D-5
139PC-6-05	C-44	13BYX-12-12	C-51	149PX-10-05-LPG	D-5
139PC-8-06	C-44	13BYX-16-12	C-51	16791N-10-10	C-24
139PX-10-08	E-128	13BYX-16-16	C-51	16791N-12-12	C-24
139PX-12-10	E-128	13BYX-2-03	C-51	16791N-4-4	C-24
139PX-16-12	E-128	13BYX-20-16	C-51	16791N-5-5	C-24
139PX-20-16	E-128	13BYX-4-03	C-51	16791N-6-6	C-24
139PX-4-03	E-128	13BYX-4-04	C-51	16791N-8-8	C-24
139PX-5-04	E-128	13BYX-6-05	C-51	16991N-10-10	C-24
139PX-6-05	E-128	13BYX-6-06	C-51	16991N-12-12	C-24
139PX-8-06	E-128	13BYX-8-06	C-51	16991N-4-4	C-24
139YX-10-08	C-54	13BYX-8-08	C-51	16991N-5-5	C-24
139YX-12-10	C-54	13D55-10-4	E-58	16991N-5-6	C-24
139YX-16-12	C-54	13D55-12-5	E-58	16991N-6-6	C-24
139YX-20-16	C-54	13D55-14-6	E-58	16991N-8-8	C-24
139YX-4-03	C-54	13D55-16-8	E-58	16ANX-12-10	E-113
139YX-5-04	C-54	13D55-20-12	E-58	16ANX-12-12	E-113
139YX-6-05	C-54	13D55-8-3	E-58	16ANX-16-16	E-113
139YX-8-06	C-54	13D56-10-4	E-74	16ANX-20-20	E-113

Part No.	Page	Part No.	Page	Part No.	Page
16ANX-8-08.....	E-113	19291N-4-5-RD.....	C-17	1AL91N-6-6C.....	C-27
16FNX-12-10.....	E-113	19291N-6-6-RD.....	C-17	1AL91N-8-8C.....	C-27
16FNX-12-12.....	E-113	19291N-6-8-RD.....	C-17	1B154-4-3.....	E-52
16FNX-16-16.....	E-113	19291N-8-10-RD.....	C-17	1B154-4-4.....	E-52
16FNX-20-20.....	E-113	1929X-6-06.....	E-94	1B154-6-6.....	E-52
16FNX-8-08.....	E-113	1929X-8-06.....	E-94	1B156-10-8.....	E-75
16NNX-12-10.....	E-114	1929X-8-08.....	E-94	1B156-12-12.....	E-75
16NNX-12-12.....	E-114	192EX-4-025.....	E-100	1B156-4-3.....	E-75
16NNX-16-16.....	E-114	192EX-6-025.....	E-100	1B156-4-4.....	E-75
16NNX-20-20.....	E-114	192NX-12-10.....	E-108	1B156-6-5.....	E-75
16NNX-8-08.....	E-114	192NX-12-12.....	E-108	1B156-6-6.....	E-75
1709.....	F-5	192NX-16-12.....	E-108	1B156-8-8.....	E-75
1711/12.6.....	F-5	192NX-16-16.....	E-108	1B1PC-12-10.....	C-39
17135.....	F-5	192NX-20-16.....	E-108	1B1PC-12-12.....	C-39
17155.....	F-5	192NX-4-04.....	E-108	1B1PC-16-16.....	C-39
1717.....	F-5	192NX-6-05.....	E-108	1B1PC-20-16.....	C-39
1718.5.....	F-5	192NX-6-06.....	E-108	1B1PC-4-04.....	C-39
1721.....	F-5	192NX-8-06.....	E-108	1B1PC-6-05.....	C-39
1728.....	F-5	192NX-8-08.....	E-108	1B1PC-6-06.....	C-39
17791N-12-12.....	C-22	192PC-12-10.....	C-38	1B1PC-8-06.....	C-39
17791N-6-6.....	C-22	192PC-12-12.....	C-38	1B1PC-8-08.....	C-39
17991N-12-12.....	C-23	192PC-16-12.....	C-38	1B1PX-12-10.....	E-121
17991N-6-6.....	C-23	192PC-16-16.....	C-38	1B1PX-12-12.....	E-121
17APX-4-03S-LPG.....	D-6	192PC-20-16.....	C-38	1B1PX-16-16.....	E-121
17APX-6-03-LPG.....	D-6	192PC-4-04.....	C-38	1B1PX-20-16.....	E-121
17APX-8-04-LPG.....	D-6	192PC-6-05.....	C-38	1B1PX-4-03.....	E-121
191PX-4-04BF.....	E-125	192PC-6-06.....	C-38	1B1PX-4-04.....	E-121
191PX-4-04C.....	E-125	192PC-8-06.....	C-38	1B1PX-6-05.....	E-121
19254-4-4.....	E-51	192PC-8-08.....	C-38	1B1PX-6-06.....	E-121
19255-12-12.....	E-59	192PX.....	E-120	1B1PX-8-06.....	E-121
19255-16-16.....	E-59	192PX-12-10.....	E-120	1B1PX-8-08.....	E-121
19255-4-4.....	E-59	192PX-12-12.....	E-120	1B1YX-12-10.....	C-49
19255-6-6.....	E-59	192PX-16-12.....	E-120	1B1YX-12-12.....	C-49
19255-8-8.....	E-59	192PX-16-16.....	E-120	1B1YX-16-16.....	C-49
19256-10-8.....	E-75	192PX-2-02.....	E-120	1B1YX-20-16.....	C-49
19256-12-12.....	E-75	192PX-2-03.....	E-120	1B1YX-4-03.....	C-49
19256-16-16.....	E-75	192PX-20-16.....	E-120	1B1YX-4-04.....	C-49
19256-2-4.....	E-75	192PX-4-03.....	E-120	1B1YX-6-05.....	C-49
19256-4-3.....	E-75	192PX-4-04.....	E-120	1B1YX-6-06.....	C-49
19256-4-4.....	E-75	192PX-6-05.....	E-120	1B1YX-8-06.....	C-49
19256-4-5.....	E-75	192PX-6-06.....	E-120	1B1YX-8-08.....	C-49
19256-6-4.....	E-75	192PX-8-06.....	E-120	1B254-4-3.....	E-52
19256-6-5.....	E-75	192YX-12-10.....	C-48	1B254-4-4.....	E-52
19256-6-6.....	E-75	192YX-12-12.....	C-48	1B254-6-5.....	E-52
19256-8-6.....	E-75	192YX-16-12.....	C-48	1B254-6-6.....	E-52
19256-8-8.....	E-75	192YX-16-16.....	C-48	1B255-12-12.....	E-59
19258-10-8.....	E-85	192YX-20-16.....	C-48	1B255-16-16.....	E-59
19258-12-12.....	E-85	192YX-4-03.....	C-48	1B255-4-4.....	E-59
19258-16-16.....	E-85	192YX-4-04.....	C-48	1B255-6-6.....	E-59
19258-4-3.....	E-85	192YX-6-05.....	C-48	1B255-8-8.....	E-59
19258-4-4.....	E-85	192YX-6-06.....	C-48	1B256-10-8.....	E-76
19258-6-5.....	E-85	192YX-8-06.....	C-48	1B256-12-12.....	E-76
19258-6-6.....	E-85	192YX-8-08.....	C-48	1B256-16-16.....	E-76
19258-8-8.....	E-85	1AL91N-12-12C.....	C-27	1B256-4-3.....	E-76
19291N-12-12-RD.....	C-17	1AL91N-16-16C.....	C-27	1B256-4-4.....	E-76
19291N-12-16-RD.....	C-17	1AL91N-4-4C.....	C-27	1B256-6-5.....	E-76
19291N-4-4-RD.....	C-17	1AL91N-4-5C.....	C-27	1B256-6-6.....	E-76

Part No.	Page	Part No.	Page	Part No.	Page
1B256-8-8	E-76	1C355-28-16	E-53	1C3YX-10-03	C-45
1B258-10-8	E-86	1C355-6-3	E-53	1C3YX-10-04	C-45
1B258-12-12	E-86	1C355-8-4	E-53	1C3YX-10-05	C-45
1B258-16-16	E-86	1C356-10-4	E-68	1C3YX-10-06	C-45
1B258-4-4	E-86	1C356-10-5	E-68	1C3YX-12-06	C-45
1B258-6-5	E-86	1C356-10-6	E-68	1C3YX-12-08	C-45
1B258-6-6	E-86	1C356-12-5	E-68	1C3YX-15-08	C-45
1B258-8-8	E-86	1C356-12-6	E-68	1C3YX-18-10	C-45
1B2PC-12-10	C-39	1C356-15-8	E-68	1C3YX-18-12	C-45
1B2PC-12-12	C-39	1C356-18-12	E-68	1C3YX-22-12	C-45
1B2PC-20-16	C-39	1C356-22-12	E-68	1C3YX-28-16	C-45
1B2PC-4-04	C-39	1C356-28-16	E-68	1C3YX-6-03	C-45
1B2PC-6-05	C-39	1C356-6-3	E-68	1C3YX-8-03	C-45
1B2PC-6-06	C-39	1C356-8-4	E-68	1C3YX-8-04	C-45
1B2PC-8-06	C-39	1C391N-10-6-RD	C-13	1C454-12-6	E-48
1B2PC-8-08	C-39	1C391N-10-8-RD	C-13	1C454-6-3	E-48
1B2PX-12-10	E-121	1C391N-12-10-RD	C-13	1C454-8-4	E-48
1B2PX-12-12	E-121	1C391N-12-8-RD	C-13	1C455-10-5	E-54
1B2PX-20-16	E-121	1C391N-15-10-RD	C-13	1C455-12-6	E-54
1B2PX-4-03	E-121	1C391N-18-10-RD	C-13	1C455-15-8	E-54
1B2PX-4-04	E-121	1C391N-18-12-RD	C-13	1C455-6-3	E-54
1B2PX-6-05	E-121	1C391N-22-16-RD	C-13	1C455-8-4	E-54
1B2PX-6-06	E-121	1C391N-28-20-RD	C-13	1C456-10-5	E-69
1B2PX-8-06	E-121	1C391N-6-4-RD	C-13	1C456-10-6	E-69
1B2PX-8-08	E-121	1C391N-6-5-RD	C-13	1C456-12-6	E-69
1B2YX-12-10	C-49	1C391N-8-5-RD	C-13	1C456-15-8	E-69
1B2YX-12-12	C-49	1C391N-8-6-RD	C-13	1C456-6-3	E-69
1B2YX-16-16	C-49	1C39X-12-06	E-92	1C456-8-4	E-69
1B2YX-20-16	C-49	1C39X-15-08	E-92	1C554-12-6	E-49
1B2YX-4-03	C-49	1C3NX-10-04	E-105	1C554-6-3	E-49
1B2YX-4-04	C-49	1C3NX-10-05	E-105	1C554-8-4	E-49
1B2YX-6-05	C-49	1C3NX-10-06	E-105	1C555-10-5	E-54
1B2YX-6-06	C-49	1C3NX-12-06	E-105	1C555-12-6	E-54
1B2YX-8-06	C-49	1C3NX-12-08	E-105	1C555-15-8	E-54
1B2YX-8-08	C-49	1C3NX-15-08	E-105	1C555-6-3	E-54
1B455-4-4	E-60	1C3NX-8-04	E-105	1C555-8-4	E-54
1B455-6-6	E-60	1C3PC-10-04	C-33	1C556-10-4	E-69
1B455-8-8	E-60	1C3PC-10-05	C-33	1C556-10-5	E-69
1B456-4-4	E-76	1C3PC-10-06	C-33	1C556-10-6	E-69
1B456-6-6	E-76	1C3PC-12-06	C-33	1C556-12-6	E-69
1B456-8-8	E-76	1C3PC-12-08	C-33	1C556-15-6	E-69
1B4PX-2-02	E-122	1C3PC-15-08	C-33	1C556-15-8	E-69
1B4PX-2-03	E-122	1C3PC-8-04	C-33	1C556-18-12	E-69
1B4PX-4-03	E-122	1C3PX-10-03	E-115	1C556-6-3	E-69
1B4PX-4-04	E-122	1C3PX-10-04	E-115	1C556-8-4	E-69
1B4YX-4-04	C-50	1C3PX-10-05	E-115	1C655-12-5	E-53
1B4YX-6-05	C-50	1C3PX-10-06	E-115	1C655-14-6	E-53
1B4YX-6-06	C-50	1C3PX-12-06	E-115	1C655-16-8	E-53
1B4YX-8-08	C-50	1C3PX-12-08	E-115	1C655-8-3	E-53
1BPEX-4-012	E-101	1C3PX-15-08	E-115	1C656-10-4	E-68
1C354-10-5	E-48	1C3PX-6-02	E-115	1C656-12-5	E-68
1C354-12-6	E-48	1C3PX-6-03	E-115	1C656-12-6	E-68
1C354-6-3	E-48	1C3PX-8-03	E-115	1C656-14-6	E-68
1C354-8-4	E-48	1C3PX-8-03-LPG	D-5	1C656-16-8	E-68
1C355-10-5	E-53	1C3PX-8-04	E-115	1C656-20-12	E-68
1C355-12-6	E-53	1C3PX-8-04-LPG	D-5	1C656-8-3	E-68
1C355-15-8	E-53	1C3PX-8-05-LPG	D-5	1C658-10-4	E-81

Part No.	Page	Part No.	Page	Part No.	Page
1C658-12-5	E-81	1C9NX-25-12	E-106	1CA58-10-6	E-81
1C658-12-6	E-81	1C9NX-30-16	E-106	1CA58-12-5	E-81
1C658-14-6	E-81	1C9NX-38-20	E-106	1CA58-12-6	E-81
1C658-14-8	E-81	1C9NX-8-04	E-106	1CA58-15-8	E-81
1C658-16-8	E-81	1C9PC-10-04	C-34	1CA58-18-10	E-81
1C658-20-12	E-81	1C9PC-12-05	C-34	1CA58-18-12	E-81
1C658-25-12	E-81	1C9PC-12-06	C-34	1CA58-22-12	E-81
1C658-30-16	E-81	1C9PC-14-06	C-34	1CA58-28-16	E-81
1C658-8-3	E-81	1C9PC-16-08	C-34	1CA58-6-3	E-81
1C6NX-10-04	E-105	1C9PC-20-10	C-34	1CA58-8-4	E-81
1C6NX-12-05	E-105	1C9PX-10-04	E-116	1CAEX-6-012	E-98
1C6NX-14-06	E-105	1C9PX-12-05	E-116	1CAEX-6-025	E-98
1C6NX-16-08	E-105	1C9PX-12-06	E-116	1CAEX-8-012	E-98
1C6NX-20-10	E-105	1C9PX-14-06	E-116	1CAPC-10-04	C-34
1C6NX-25-12	E-105	1C9PX-16-08	E-116	1CAPC-10-05	C-34
1C6NX-30-16	E-105	1C9PX-20-10	E-116	1CAPC-10-06	C-34
1C6NX-8-04	E-105	1C9PX-25-12	E-116	1CAPC-12-05	C-34
1C955-10-4	E-55	1C9PX-30-16	E-116	1CAPC-12-06	C-34
1C955-12-5	E-55	1C9PX-6-03	E-116	1CAPC-15-08	C-34
1C955-14-6	E-55	1C9PX-8-03	E-116	1CAPC-18-10	C-34
1C955-16-8	E-55	1C9YX-10-04	C-46	1CAPC-22-12	C-34
1C955-25-12	E-55	1C9YX-12-05	C-46	1CAPC-28-16	C-34
1C955-30-16	E-55	1C9YX-14-06	C-46	1CAPC-6-04	C-34
1C955-8-3	E-55	1C9YX-16-08	C-46	1CAPC-8-04	C-34
1C956-10-4	E-70	1C9YX-20-10	C-46	1CAPX-10-04	E-116
1C956-10-5	E-70	1C9YX-25-12	C-46	1CAPX-10-05	E-116
1C956-12-4	E-70	1C9YX-30-16	C-46	1CAPX-10-06	E-116
1C956-12-5	E-70	1C9YX-8-03	C-46	1CAPX-12-05	E-116
1C956-12-6	E-70	1C9YX-8-04	C-46	1CAPX-12-06	E-116
1C956-14-6	E-70	1CA54-10-5	E-49	1CAPX-15-08	E-116
1C956-16-8	E-70	1CA54-10-6	E-49	1CAPX-18-10	E-116
1C956-20-12	E-70	1CA54-12-6	E-49	1CAPX-22-12	E-116
1C956-25-12	E-70	1CA54-6-3	E-49	1CAPX-28-16	E-116
1C956-8-3	E-70	1CA54-8-4	E-49	1CAPX-6-03	E-116
1C956-8-4	E-70	1CA55-10-5	E-55	1CAPX-6-04	E-116
1C958-10-4	E-82	1CA55-10-6	E-55	1CAPX-8-04	E-116
1C958-12-5	E-82	1CA55-12-6	E-55	1CAYX-10-04	C-46
1C958-12-6	E-82	1CA55-15-8	E-55	1CAYX-10-05	C-46
1C958-14-6	E-82	1CA55-18-12	E-55	1CAYX-12-06	C-46
1C958-16-8	E-82	1CA55-22-12	E-55	1CAYX-15-08	C-46
1C958-20-10	E-82	1CA55-28-16	E-55	1CAYX-18-10	C-46
1C958-20-12	E-82	1CA55-6-3	E-55	1CAYX-22-12	C-46
1C958-25-12	E-82	1CA55-8-4	E-55	1CAYX-28-16	C-46
1C958-30-16	E-82	1CA56-10-4	E-70	1CAYX-6-03	C-46
1C958-8-3	E-82	1CA56-10-5	E-70	1CAYX-8-04	C-46
1C99X-12-06	E-92	1CA56-10-6	E-70	1CE54-10-5	E-50
1C99X-14-06	E-92	1CA56-12-5	E-70	1CE54-10-6	E-50
1C99X-16-08	E-92	1CA56-12-6	E-70	1CE54-12-6	E-50
1C9EX-6-012	E-98	1CA56-15-8	E-70	1CE54-6-3	E-50
1C9EX-8-012	E-98	1CA56-18-12	E-70	1CE54-8-4	E-50
1C9EX-8-02	E-98	1CA56-18-8	E-70	1CE55-10-5	E-56
1C9EX-8-025	E-98	1CA56-22-12	E-70	1CE55-12-6	E-56
1C9NX-10-04	E-106	1CA56-28-16	E-70	1CE55-15-8	E-56
1C9NX-12-05	E-106	1CA56-6-3	E-70	1CE55-18-12	E-56
1C9NX-14-06	E-106	1CA56-6-4	E-70	1CE55-22-12	E-56
1C9NX-16-08	E-106	1CA56-8-4	E-70	1CE55-6-3	E-56
1C9NX-20-10	E-106	1CA58-10-5	E-81	1CE55-8-4	E-56

Part No.	Page	Part No.	Page	Part No.	Page
1CE56-10-4.....	E-71	1CF56-8-4.....	E-72	1D058-8-4.....	E-84
1CE56-10-5.....	E-71	1CF58-10-5.....	E-83	1D091N-10-6.....	C-14
1CE56-10-6.....	E-71	1CF58-10-6.....	E-83	1D091N-10-8.....	C-14
1CE56-12-6.....	E-71	1CF58-12-6.....	E-83	1D091N-12-10.....	C-14
1CE56-15-8.....	E-71	1CF58-15-8.....	E-83	1D091N-12-8.....	C-14
1CE56-18-12.....	E-71	1CF58-18-10.....	E-83	1D091N-15-10.....	C-14
1CE56-22-12.....	E-71	1CF58-18-12.....	E-83	1D091N-18-12.....	C-14
1CE56-6-3.....	E-71	1CF58-22-12.....	E-83	1D091N-22-16.....	C-14
1CE56-8-4.....	E-71	1CF58-28-16.....	E-83	1D091N-28-20.....	C-14
1CE58-10-5.....	E-82	1CF58-6-3.....	E-83	1D091N-6-4.....	C-14
1CE58-10-6.....	E-82	1CF58-8-4.....	E-83	1D091N-8-5.....	C-14
1CE58-12-6.....	E-82	1CFPC-10-05.....	C-36	1D091N-8-6.....	C-14
1CE58-15-8.....	E-82	1CFPC-10-06.....	C-36	1D0PC-10-05.....	C-37
1CE58-18-10.....	E-82	1CFPC-12-06.....	C-36	1D0PC-10-06.....	C-37
1CE58-18-12.....	E-82	1CFPC-15-08.....	C-36	1D0PC-12-06.....	C-37
1CE58-22-12.....	E-82	1CFPC-18-10.....	C-36	1D0PC-15-06.....	C-37
1CE58-6-3.....	E-82	1CFPC-22-12.....	C-36	1D0PC-15-08.....	C-37
1CE58-8-4.....	E-82	1CFPC-6-04.....	C-36	1D0PC-18-10.....	C-37
1CEPC-10-05.....	C-35	1CFPC-8-04.....	C-36	1D0PC-22-12.....	C-37
1CEPC-10-06.....	C-35	1CFPC-10-05.....	E-118	1D0PC-28-16.....	C-37
1CEPC-12-06.....	C-35	1CFPX-10-06.....	E-118	1D0PC-6-04.....	C-37
1CEPC-15-08.....	C-35	1CFPX-12-06.....	E-118	1D0PC-8-04.....	C-37
1CEPC-18-10.....	C-35	1CFPX-15-08.....	E-118	1D0PC-8-05.....	C-37
1CEPC-22-12.....	C-35	1CFPX-18-10.....	E-118	1D0PX-10-05.....	E-119
1CEPC-28-16.....	C-35	1CFPX-22-12.....	E-118	1D0PX-10-06.....	E-119
1CEPC-6-04.....	C-35	1CFPX-28-16.....	E-118	1D0PX-12-05.....	E-119
1CEPC-8-04.....	C-35	1CFPX-6-03.....	E-118	1D0PX-12-06.....	E-119
1CEPX-10-05.....	E-117	1CFPX-6-04.....	E-118	1D0PX-15-06.....	E-119
1CEPX-10-06.....	E-117	1CFPX-8-04.....	E-118	1D0PX-15-08.....	E-119
1CEPX-12-06.....	E-117	1D055-10-5.....	E-57	1D0PX-18-10.....	E-119
1CEPX-15-08.....	E-117	1D055-12-6.....	E-57	1D0PX-22-12.....	E-119
1CEPX-18-10.....	E-117	1D055-15-8.....	E-57	1D0PX-28-16.....	E-119
1CEPX-22-12.....	E-117	1D055-18-12.....	E-57	1D0PX-6-03.....	E-119
1CEPX-28-16.....	E-117	1D055-22-12.....	E-57	1D0PX-6-04.....	E-119
1CEPX-6-03.....	E-117	1D055-6-3.....	E-57	1D0PX-8-04.....	E-119
1CEPX-6-04.....	E-117	1D055-8-4.....	E-57	1D0PX-8-05.....	E-119
1CEPX-8-04.....	E-117	1D056-10-5.....	E-73	1D0YX-10-05.....	C-47
1CF54-10-6.....	E-50	1D056-10-6.....	E-73	1D0YX-12-06.....	C-47
1CF54-6-3.....	E-50	1D056-12-5.....	E-73	1D0YX-15-08.....	C-47
1CF55-10-5.....	E-56	1D056-12-6.....	E-73	1D0YX-18-10.....	C-47
1CF55-12-6.....	E-56	1D056-15-6.....	E-73	1D0YX-22-12.....	C-47
1CF55-15-8.....	E-56	1D056-15-8.....	E-73	1D0YX-28-16.....	C-47
1CF55-22-12.....	E-56	1D056-18-12.....	E-73	1D0YX-6-03.....	C-47
1CF55-28-16.....	E-56	1D056-22-12.....	E-73	1D0YX-8-04.....	C-47
1CF55-6-3.....	E-56	1D056-28-16.....	E-73	1D255-10-4.....	E-57
1CF55-8-4.....	E-56	1D056-6-3.....	E-73	1D255-12-5.....	E-57
1CF56-10-4.....	E-72	1D056-8-4.....	E-73	1D255-14-6.....	E-57
1CF56-10-5.....	E-72	1D058-10-5.....	E-84	1D255-16-8.....	E-57
1CF56-10-6.....	E-72	1D058-10-6.....	E-84	1D255-20-12.....	E-57
1CF56-12-5.....	E-72	1D058-12-5.....	E-84	1D255-25-12.....	E-57
1CF56-12-6.....	E-72	1D058-12-6.....	E-84	1D255-8-3.....	E-57
1CF56-15-8.....	E-72	1D058-15-6.....	E-84	1D256-10-4.....	E-73
1CF56-18-12.....	E-72	1D058-15-8.....	E-84	1D256-12-5.....	E-73
1CF56-22-12.....	E-72	1D058-18-12.....	E-84	1D256-14-6.....	E-73
1CF56-28-16.....	E-72	1D058-22-12.....	E-84	1D256-16-6.....	E-73
1CF56-6-3.....	E-72	1D058-28-16.....	E-84	1D256-16-8.....	E-73
1CF56-6-4.....	E-72	1D058-6-3.....	E-84	1D256-20-12.....	E-73

Part No.	Page	Part No.	Page	Part No.	Page
1D256-8-3	E-73	1D958-12-12	E-86	1EN56-22-12	E-78
1D258-10-4	E-85	1D958-16-16	E-86	1EN56-6-3	E-78
1D258-12-5	E-85	1D958-4-4	E-86	1EN56-8-4	E-78
1D258-14-6	E-85	1D958-6-5	E-86	1ET56-10-4	E-79
1D258-16-8	E-85	1D958-6-6	E-86	1ET56-10-5	E-79
1D258-20-12	E-85	1D958-8-8	E-86	1ET56-12-6	E-79
1D258-25-12	E-85	1D991N-12-12	C-17	1ET56-15-8	E-79
1D258-30-16	E-85	1D991N-12-16	C-17	1ET56-18-10	E-79
1D258-8-3	E-85	1D991N-4-4	C-17	1ET56-22-12	E-79
1D29X-14-06	E-94	1D991N-4-5	C-17	1ET56-6-3	E-79
1D29X-16-08	E-94	1D991N-6-6	C-17	1ET56-8-4	E-79
1D2NX-10-04	E-107	1D991N-6-8	C-17	1EU56-10-4	E-79
1D2NX-12-05	E-107	1D991N-8-10	C-17	1EU56-10-5	E-79
1D2NX-14-06	E-107	1D9EX-4-012	E-100	1EU56-12-6	E-79
1D2NX-16-08	E-107	1D9PC-12-10	C-40	1EU56-15-8	E-79
1D2NX-20-10	E-107	1D9PC-12-12	C-40	1EU56-18-10	E-79
1D2NX-25-12	E-107	1D9PC-16-12	C-40	1EU56-22-12	E-79
1D2NX-30-16	E-107	1D9PC-20-16	C-40	1EU56-6-3	E-79
1D2PC-10-04	C-37	1D9PC-4-04	C-40	1EU56-8-4	E-79
1D2PC-12-05	C-37	1D9PC-6-05	C-40	1GAPX-12-04BF	E-131
1D2PC-12-06	C-37	1D9PC-6-06	C-40	1GAPX-12-04C	E-131
1D2PC-14-05	C-37	1D9PC-8-06	C-40	1GAPX-8-04BF	E-131
1D2PC-14-06	C-37	1D9PC-8-08	C-40	1GAPX-8-04BF2	E-132
1D2PC-16-08	C-37	1D9PX-12-10	E-123	1GAPX-8-04C	E-131
1D2PC-20-10	C-37	1D9PX-12-12	E-123	1GAPX-8-04CS	E-132
1D2PC-25-12	C-37	1D9PX-16-12	E-123	1J0 55-8-6-SM	E-66
1D2PC-30-16	C-37	1D9PX-2-02	E-123	1J055-4-4-SM	E-66
1D2PC-8-04	C-37	1D9PX-2-03	E-123	1J055-6-6-SM	E-66
1D2PX-10-04	E-119	1D9PX-20-16	E-123	1J155-12-12	E-67
1D2PX-12-05	E-119	1D9PX-4-03	E-123	1J155-16-16	E-67
1D2PX-12-06	E-119	1D9PX-4-04	E-123	1J155-4-4	E-67
1D2PX-14-05	E-119	1D9PX-6-05	E-123	1J155-6-6	E-67
1D2PX-14-06	E-119	1D9PX-6-06	E-123	1J155-8-6	E-67
1D2PX-16-08	E-119	1D9PX-8-06	E-123	1J155-8-8	E-67
1D2PX-20-10	E-119	1D9PX-8-08	E-123	1J191N-10-10	C-26
1D2PX-25-12	E-119	1D9YX-12-10	C-51	1J191N-12-12	C-26
1D2PX-30-16	E-119	1D9YX-12-12	C-51	1J191N-16-16	C-26
1D2PX-8-03	E-119	1D9YX-16-12	C-51	1J191N-4-4	C-26
1D2PX-8-04	E-119	1D9YX-2-03	C-51	1J191N-4-5	C-26
1D2YX-10-04	C-47	1D9YX-20-16	C-51	1J191N-6-5	C-26
1D2YX-12-05	C-47	1D9YX-4-03	C-51	1J191N-6-6	C-26
1D2YX-14-06	C-47	1D9YX-4-04	C-51	1J191N-8-6	C-26
1D2YX-16-08	C-47	1D9YX-4-06	C-51	1J191N-8-8	C-26
1D2YX-20-10	C-47	1D9YX-6-05	C-51	1J755-12-12	E-66
1D2YX-25-12	C-47	1D9YX-6-06	C-51	1J755-16-16	E-66
1D2YX-30-16	C-47	1D9YX-8-06	C-51	1J755-4-4	E-66
1D2YX-8-03	C-47	1D9YX-8-08	C-51	1J755-6-4	E-66
1D955-12-12	E-60	1DAB-10-05	E-96	1J755-6-6	E-66
1D955-16-16	E-60	1DAB-12-06	E-96	1J755-8-6	E-66
1D955-4-4	E-60	1DAB-15-06	E-96	1J755-8-8	E-66
1D955-6-6	E-60	1DAB-6-025	E-96	1J758-12-12	E-90
1D955-8-8	E-60	1DAB-8-04	E-96	1J758-16-16	E-90
1D956-12-12	E-77	1EN56-10-4	E-78	1J758-4-4	E-90
1D956-4-4	E-77	1EN56-10-5	E-78	1J758-6-4	E-90
1D956-6-5	E-77	1EN56-12-6	E-78	1J758-6-6	E-90
1D956-6-6	E-77	1EN56-15-8	E-78	1J758-8-6	E-90
1D956-8-8	E-77	1EN56-18-10	E-78	1J758-8-8	E-90

Part No.	Page	Part No.	Page	Part No.	Page
1J791N-10-10	C-25	1JC55-4-5-SM	E-65	1JS58-10-10-SM	E-90
1J791N-12-12	C-25	1JC55-6-4-SM	E-65	1JS58-12-12-SM	E-90
1J791N-16-16	C-25	1JC55-6-5-SM	E-65	1JS58-16-16-SM	E-90
1J791N-4-4	C-25	1JC55-6-6-SM	E-65	1JS58-4-3-SM	E-90
1J791N-4-6	C-25	1JC55-8-6-SM	E-65	1JS58-4-4-SM	E-90
1J791N-6-6	C-25	1JC55-8-8-SM	E-65	1JS58-4-5-SM	E-90
1J791N-8-8	C-25	1JC58-10-8-SM	E-89	1JS58-6-4-SM	E-90
1J793N-16-16	C-32	1JC58-12-12-SM	E-89	1JS58-6-5-SM	E-90
1J793N-20-20	C-32	1JC58-16-16-SM	E-89	1JS58-6-6-SM	E-90
1J7PX-12-12	E-130	1JC58-4-3-SM	E-89	1JS58-8-6-SM	E-90
1J7PX-16-16	E-130	1JC58-4-4-SM	E-89	1JS58-8-8-SM	E-90
1J7PX-4-03	E-130	1JC58-4-5-SM	E-89	1JSPX-12-12	E-129
1J7PX-4-04	E-130	1JC58-6-4-SM	E-89	1JSPX-16-16	E-129
1J7PX-4-05	E-130	1JC58-6-5-SM	E-89	1JSPX-4-03	E-129
1J7PX-6-04	E-130	1JC58-6-6-SM	E-89	1JSPX-4-04	E-129
1J7PX-6-05	E-130	1JC58-8-6-SM	E-89	1JSPX-4-05	E-129
1J7PX-6-06	E-130	1JC58-8-8-SM	E-89	1JSPX-6-04	E-129
1J7PX-8-06	E-130	1JC91N-10-10	C-25	1JSPX-6-05	E-129
1J7PX-8-08	E-130	1JC91N-12-10	C-25	1JSPX-6-06	E-129
1J955-12-12	E-67	1JC91N-12-12	C-25	1JSPX-8-06	E-129
1J955-16-16	E-67	1JC91N-16-16	C-25	1JSPX-8-08	E-129
1J955-4-4	E-67	1JC91N-20-16	C-25	1P691N-12-12C	C-27
1J955-6-4	E-67	1JC91N-20-20	C-25	1P691N-16-16C	C-27
1J955-6-5	E-67	1JC91N-4-4	C-25	1P691N-4-4C	C-27
1J955-6-6	E-67	1JC91N-6-6	C-25	1P691N-4-5C	C-27
1J955-8-8	E-67	1JC91N-8-8	C-25	1P691N-6-6C	C-27
1J958-12-12	E-91	1JC93N-16-16	C-31	1P691N-8-8C	C-27
1J958-16-16	E-91	1JC93N-20-20	C-31	1PHPX-5.5-03S-LPG	D-7
1J958-4-4	E-91	1JCEX-4-012	E-102	1Q191N-12-12C	C-28
1J958-6-4	E-91	1JCEX-6-012	E-102	1Q191N-4-4C	C-28
1J958-6-5	E-91	1JCPX-12-12	E-129	1Q191N-6-6C	C-28
1J958-6-6	E-91	1JCPX-16-16	E-129	1Q191N-8-8C	C-28
1J958-8-8	E-91	1JCPX-4-03	E-129	1R8EX-11-012	E-103
1J991N-10-10	C-26	1JCPX-4-04	E-129	1TU91N-12-12C	C-28
1J991N-12-12	C-26	1JCPX-4-05	E-129	1TU91N-16-16C	C-28
1J991N-16-16	C-26	1JCPX-6-04	E-129	1TU91N-4-4C	C-28
1J991N-20-20	C-26	1JCPX-6-05	E-129	1TU91N-6-6C	C-28
1J991N-4-4	C-26	1JCPX-6-06	E-129	1TU91N-8-8C	C-28
1J991N-6-6	C-26	1JCPX-8-06	E-129	1U0NX	E-108
1J991N-8-8	C-26	1JCPX-8-08	E-129	1U0NX-12-10	E-108
1J993N-16-16	C-32	1JMPX-12-12	E-130	1U0NX-12-12	E-108
1J993N-20-20	C-32	1JMPX-16-16	E-130	1U0NX-16-12	E-108
1J9PX-12-12	E-131	1JMPX-4-04	E-130	1U0NX-4-04	E-108
1J9PX-16-16	E-131	1JMPX-6-06	E-130	1U0NX-6-04	E-108
1J9PX-4-03	E-131	1JMPX-8-06	E-130	1U0NX-6-06	E-108
1J9PX-4-04	E-131	1JMPX-8-08	E-130	1U0NX-8-06	E-108
1J9PX-4-05	E-131	1JS55-10-10-SM	E-65	1U0NX-8-08	E-108
1J9PX-6-04	E-131	1JS55-12-12-SM	E-65	1U0PC-12-10	C-40
1J9PX-6-05	E-131	1JS55-16-16-SM	E-65	1U0PC-12-12	C-40
1J9PX-6-06	E-131	1JS55-4-3-SM	E-65	1U0PC-16-12	C-40
1J9PX-8-06	E-131	1JS55-4-4-SM	E-65	1U0PC-16-16	C-40
1J9PX-8-08	E-131	1JS55-4-5-SM	E-65	1U0PC-20-16	C-40
1JC55-10-8-SM	E-65	1JS55-6-4-SM	E-65	1U0PC-4-04	C-40
1JC55-12-12-SM	E-65	1JS55-6-5-SM	E-65	1U0PC-6-05	C-40
1JC55-16-16-SM	E-65	1JS55-6-6-SM	E-65	1U0PC-6-06	C-40
1JC55-4-3-SM	E-65	1JS55-8-6-SM	E-65	1U0PC-8-06	C-40
1JC55-4-4-SM	E-65	1JS55-8-8-SM	E-65	1U0PC-8-08	C-40

Index



Part No.	Page	Part No.	Page	Part No.	Page
1U0PX-12-10.....	E-122	2030T-05R14.....	C-4	2040N-06V00-P.....	E-37
1U0PX-12-12.....	E-122	2030T-05V70.....	C-3, E-30	2040N-06V30.....	E-16
1U0PX-16-12.....	E-122	2030T-06CON.....	C-5	2040N-08V00.....	E-16, E-28
1U0PX-16-16.....	E-122	2030T-06R14.....	C-4	2040N-08V00-P.....	E-37
1U0PX-20-16.....	E-122	2030T-06V70.....	C-3, E-30	2040N-08V30.....	E-16
1U0PX-4-02.....	E-122	2030T-08CON.....	C-5	2040N-10V00.....	E-16, E-28
1U0PX-4-03.....	E-122	2030T-08R14.....	C-4	2040N-10V00-P.....	E-37
1U0PX-4-03-LPG.....	D-6	2030T-08V70.....	C-3, E-30	2040N-12V00.....	E-16, E-28
1U0PX-4-04.....	E-122	2030T-10CON.....	C-5	2040N-12V00-P.....	E-37
1U0PX-4-04-LPG.....	D-6	2030T-10R14.....	C-4	2040N-16V00.....	E-16, E-28
1U0PX-4-05-LPG.....	D-6	2030T-10V70.....	C-3, E-30	2040N-16V00-P.....	E-37
1U0PX-6-03.....	E-122	2030T-12CON.....	C-5	2244N-20V30.....	E-25
1U0PX-6-04.....	E-122	2030T-12R14.....	C-4	2245N-04V00.....	E-25
1U0PX-6-05.....	E-122	2030T-12V70.....	C-3, E-30	2245N-05V00.....	E-25
1U0PX-6-06.....	E-122	2030T-16CON.....	C-5	2245N-06V00.....	E-25
1U0PX-8-06.....	E-122	2030T-16R14.....	C-4	2245N-08V00.....	E-25
1U0PX-8-08.....	E-122	2030T-16V70.....	C-3, E-30	2245N-10V30.....	E-25
1U0YX-10-08.....	C-50	2030T-20CON.....	C-5	2245N-12V30.....	E-25
1U0YX-12-10.....	C-50	2030TB-04CON.....	C-6	2245N-16V30.....	E-25
1U0YX-12-12.....	C-50	2030TB-05CON.....	C-6	2246F-04V70.....	C-12
1U0YX-16-12.....	C-50	2030TB-06CON.....	C-6	2246F-05V70.....	C-12
1U0YX-16-16.....	C-50	2030TB-08CON.....	C-6	2246F-06V70.....	C-12
1U0YX-2-03.....	C-50	2030TB-10CON.....	C-6	2246F-08V70.....	C-12
1U0YX-20-16.....	C-50	2030TB-12CON.....	C-6	2246F-10V70.....	C-12
1U0YX-4-03.....	C-50	2030TB-16CON.....	C-6	2246F-12V70.....	C-12
1U0YX-4-04.....	C-50	2030TB-20CON.....	C-6	2246F-16V70.....	C-12
1U0YX-6-03.....	C-50	2033T-04V70.....	C-7, E-31	2370H-08V10.....	E-24
1U0YX-6-04.....	C-50	2033T-05V70.....	C-7, E-31	2370N-04V10.....	E-24, E-29
1U0YX-6-05.....	C-50	2033T-06V70.....	C-7, E-31	2370N-05V10.....	E-24, E-29
1U0YX-6-06.....	C-50	2033T-08V70.....	C-7, E-31	2370N-06V10.....	E-24, E-29
1U0YX-8-06.....	C-50	2033T-10V70.....	C-7, E-31	2370N-08V10.....	E-24, E-29
1U0YX-8-08.....	C-50	2033T-12V70.....	C-7, E-31	2380F-04V07.....	C-11
1YPEX-3-012.....	E-104	2033T-16V70.....	C-7, E-31	2380F-05V07.....	C-11
1YREX-10-012.....	E-104	2040H-03V10.....	E-17	2380F-06V07.....	C-11
1YREX-11-012.....	E-104	2040H-04-04V10V10.....	E-43	2380F-08V07.....	C-11
1YW91N-10-6C.....	C-29	2040H-04V10.....	E-17	2380F-10V07.....	C-11
1YW91N-12-8C.....	C-29	2040H-05-05V10V10.....	E-43	2380F-12V07.....	C-11
1YW91N-18-12C.....	C-29	2040H-05V10.....	E-17	2380F-16V07.....	C-11
1YW91N-6-4C.....	C-29	2040H-06-06V10V10.....	E-43	30182-12-12.....	B-18
1YW91N-8-4C.....	C-29	2040H-06V10.....	E-17	30182-12-12B.....	B-18
200AF-025.....	E-97	2040H-08-08V10V10.....	E-43	30182-12-12C.....	B-18
200AF-04.....	E-97	2040H-08V10.....	E-17	30182-2-4.....	B-18
200AF-05.....	E-97	2040H-10V10.....	E-17	30182-2-4-SM.....	B-18
200AF-06.....	E-97	2040H-12V10.....	E-17	30182-2-4B.....	B-18
2010H-025V00.....	E-3	2040H-16V10.....	E-17	30182-4-4.....	B-18
2010N-012V30.....	E-3	2040N-02V00.....	E-16, E-28	30182-4-4-SM.....	B-18
2020N-012V30.....	E-4	2040N-03V00.....	E-16, E-28	30182-4-4B.....	B-18
2020N-012V50.....	E-4	2040N-03V00-P.....	E-37	30182-4-4C.....	B-18
2020N-016V30.....	E-4	2040N-03V30.....	E-16	30182-4-6.....	B-18
2020N-025V30.....	E-4	2040N-04V00.....	E-16, E-28	30182-4-6-SM.....	B-18
2020N-025V50.....	E-4	2040N-04V00-P.....	E-37	30182-4-6B.....	B-18
2020N-02V30.....	E-4	2040N-04V30.....	E-16	30182-6-6.....	B-18
2030T-03V70.....	C-3, E-30	2040N-04V74-P.....	E-38	30182-6-6-SM.....	B-18
2030T-04CON.....	C-5	2040N-05V00.....	E-16, E-28	30182-6-6B.....	B-18
2030T-04R14.....	C-4	2040N-05V00-P.....	E-37	30182-6-6C.....	B-18
2030T-04V70.....	C-3, E-30	2040N-05V30.....	E-16	30182-6-8.....	B-18
2030T-05CON.....	C-5	2040N-06V00.....	E-16, E-28	30182-6-8B.....	B-18

Part No.	Page	Part No.	Page	Part No.	Page
30182-8-10-SM	B-18	30882-4-4	B-23	34982-14-8	B-27
30182-8-10B	B-18	30882-4-4B	B-23	34982-16-6	B-27
30182-8-12-SM	B-18	30882-5-4B	B-23	34982-17-6	B-27
30182-8-12B	B-18	30882-6-6	B-23	34982-17-6C	B-27
30182-8-4C	B-18	30882-6-6B	B-23	34982-18-8	B-27
30182-8-6-SM	B-18	30882-8-8	B-23	34982-22-10	B-27
30182-8-6B-SM	B-18	30882-8-8B	B-23	34982-22-8	B-27
30182-8-8	B-18	31382-12-12	B-19	34982-26-12	B-27
30182-8-8B	B-18	31382-4-4	B-19	34982-8-4	B-27
30182-8-8B-SM	B-18	31382-4-6	B-19	35C82-10-6B	B-12
30182-8-8C	B-18	31382-6-6	B-19	35C82-10-6BK	B-12
30282-4-4B	B-19	31382-8-8	B-19	35C82-12x1-4BK	B-12
30282-4-4C-SM	B-19	31D82-10-6	B-11	35C82-15-8B	B-12
30282-6-6B	B-19	31D82-10-6B	B-11	35C82-15-8BK	B-12
30282-8-8B	B-19	31D82-10-6C	B-11	35C82-18-10BK	B-12
30282-8-8C	B-19	31D82-12-6	B-11	35C82-6-4BK	B-12
30382-12-12	B-20	31D82-12-6B	B-11	36882-10-10C-SM	B-21
30382-12-12B	B-20	31D82-12-6C	B-11	36882-5-4C-SM	B-21
30382-4-4	B-20	31D82-15-8	B-11	36882-8-6-SM	B-21
30382-4-4B	B-20	31D82-15-8B	B-11	36882-8-6C-SM	B-21
30382-6-6	B-20	31D82-15-8C	B-11	36C82-10-6B	B-12
30382-6-6B	B-20	31D82-18-10	B-11	36C82-10-6BK	B-12
30382-8-8	B-20	31D82-18-10B	B-11	36C82-12x1-4BK	B-12
30382-8-8B	B-20	31D82-22-12	B-11	36C82-15-8BK	B-12
30682-10-10	B-21	31D82-22-12B	B-11	36C82-6-4B	B-12
30682-10-10-SM	B-21	31D82-6-4	B-11	36C82-6-4BK	B-12
30682-10-10B	B-21	31D82-6-4B	B-11	37C82-10-6B	B-13
30682-10-8-SM	B-21	31D82-8-4	B-11	37C82-10-6BK	B-13
30682-10-8B	B-21	31D82-8-4B	B-11	37C82-12x1-4B	B-13
30682-12-12	B-21	33482-10-10B	B-17	37C82-12x1-4BK	B-13
30682-12-12-SM	B-21	33482-12-12B	B-17	37C82-15-8B	B-13
30682-12-12B	B-21	33482-4-4B	B-17	37C82-15-8BK	B-13
30682-12-12B-SM	B-21	33482-6-6B	B-17	37C82-6-4B	B-13
30682-12-12C	B-21	33482-8-8B	B-17	37C82-6-4BK	B-13
30682-12-12C-SM	B-21	33782-4-4	B-22	38282-10-10	B-28
30682-16-16-SM	B-21	33782-6-6	B-22	38282-10-10B	B-28
30682-16-16C-SM	B-21	33782-6-6-SM	B-22	38282-12-12	B-28
30682-4-4	B-21	33782-8-8	B-22	38282-12-12B	B-28
30682-4-4-SM	B-21	33982-10-10	B-22	38282-4-4	B-28
30682-4-4B	B-21	33982-12-12	B-22	38282-4-4B	B-28
30682-4-4C	B-21	33982-12-12-SM	B-22	38282-6-6	B-28
30682-5-4	B-21	33982-4-4	B-22	38282-6-6B	B-28
30682-5-4B	B-21	33982-6-6	B-22	38282-8-8	B-28
30682-5-6B	B-21	33982-6-6-SM	B-22	38282-8-8B	B-28
30682-6-4B	B-21	33982-6-6C-SM	B-22	39182-12-10B	B-17
30682-6-6	B-21	33982-8-8	B-22	39182-12-12	B-17
30682-6-6-SM	B-21	33V82-4-4B-SM	B-22	39182-12-12B	B-17
30682-6-6B-SM	B-21	33W82-4-4C-SM	B-22	39182-16-16B	B-17
30682-6-6C	B-21	33W82-8-8-SM	B-22	39182-2-4	B-17
30682-6-6C-SM	B-21	34982-10-4	B-27	39182-2-4B	B-17
30682-8-6B	B-21	34982-10-6	B-27	39182-4-4	B-17
30682-8-8	B-21	34982-12-4	B-27	39182-4-4B	B-17
30682-8-8B	B-21	34982-12-6	B-27	39182-4-6	B-17
30882-10-10	B-23	34982-14-4	B-27	39182-4-6B	B-17
30882-10-10B	B-23	34982-14-4C	B-27	39182-6-6	B-17
30882-12-12	B-23	34982-14-6	B-27	39182-6-6B	B-17
30882-12-12B	B-23	34982-14-6C	B-27	39182-6-8B	B-17

Part No.	Page	Part No.	Page	Part No.	Page
39182-8-10B	B-17	3C382-10-4	B-4	3C582-12-6B	B-6
39182-8-8	B-17	3C382-10-4BK	B-4	3C582-12-6C	B-6
39182-8-8B	B-17	3C382-10-4C	B-4	3C582-15-8	B-6
39282-10-10	B-14	3C382-10-6	B-4	3C582-15-8B	B-6
39282-10-10B	B-14	3C382-10-6B	B-4	3C582-15-8C	B-6
39282-12-10C	B-14	3C382-10-6BK	B-4	3C582-18-10	B-6
39282-12-12	B-14	3C382-10-6C	B-4	3C582-22-12	B-6
39282-12-12B	B-14	3C382-12-6	B-4	3C582-22-12B	B-6
39282-16-16	B-14	3C382-12-6BK	B-4	3C582-22-12C	B-6
39282-4-4	B-14	3C382-12-6C	B-4	3C582-28-16-K	B-6
39282-4-4B	B-14	3C382-15-10	B-4	3C582-6-4	B-6
39282-4-4C	B-14	3C382-15-8	B-4	3C582-6-4B	B-6
39282-6-4B	B-14	3C382-15-8B	B-4	3C582-8-4	B-6
39282-6-6	B-14	3C382-15-8BK	B-4	3C582-8-4B	B-6
39282-6-6B	B-14	3C382-15-8C	B-4	3CA82-10-4	B-8
39282-6-6C	B-14	3C382-18-10	B-4	3CA82-10-6	B-8
39282-8-8	B-14	3C382-18-10C	B-4	3CA82-10-6B	B-8
39282-8-8B	B-14	3C382-22-12	B-4	3CA82-12-6	B-8
39282-8-8C	B-14	3C382-22-12B	B-4	3CA82-12-6B	B-8
39B82-10-6BK	B-7	3C382-22-12BK	B-4	3CA82-15-10	B-8
39B82-12-6BK	B-7	3C382-28-16	B-4	3CA82-15-10B	B-8
39B82-15-8BK	B-7	3C382-28-16BK	B-4	3CA82-15-8	B-8
39B82-6-4BK	B-7	3C382-28-16C-K	B-4	3CA82-15-8B	B-8
39B82-8-4BK	B-7	3C382-6-4	B-4	3CA82-18-10	B-8
39C82-10-6BK	B-7	3C382-6-4B	B-4	3CA82-22-12	B-8
39C82-12-6BK	B-7	3C382-6-4BK	B-4	3CA82-22-12B	B-8
39C82-15-8BK	B-7	3C382-6-4C	B-4	3CA82-6-4	B-8
39C82-6-4BK	B-7	3C382-8-4	B-4	3CA82-6-4B	B-8
39C82-8-4BK	B-7	3C382-8-4B	B-4	3CA82-8-4	B-8
3AF82-2-4B	B-24	3C382-8-4BK	B-4	3CA82-8-4B	B-8
3AF82-4-4B	B-24	3C382-8-4C	B-4	3CE82-10-6	B-9
3AF82-4-4C	B-24	3C482-10-6	B-5	3CE82-12-6	B-9
3AF82-4-6B	B-24	3C482-10-6B	B-5	3CE82-15-8	B-9
3AF82-6-6B	B-24	3C482-10-6C	B-5	3CE82-18-10	B-9
3AF82-6-8B	B-24	3C482-12-6	B-5	3CE82-22-12	B-9
3AF82-8-10B	B-24	3C482-12-6B	B-5	3CE82-6-4	B-9
3AF82-8-8B	B-24	3C482-15-10	B-5	3CE82-8-4	B-9
3B182-10-10	B-15	3C482-15-10B	B-5	3CF82-10-4	B-9
3B182-12-12	B-15	3C482-15-8	B-5	3CF82-10-6	B-9
3B182-16-16-K	B-15	3C482-15-8B	B-5	3CF82-10-6B	B-9
3B182-4-4	B-15	3C482-18-10	B-5	3CF82-12-6	B-9
3B182-6-6	B-15	3C482-18-10B	B-5	3CF82-12-6B	B-9
3B182-6-6B	B-15	3C482-18-12	B-5	3CF82-15-8	B-9
3B182-8-8	B-15	3C482-22-12	B-5	3CF82-18-10	B-9
3B182-8-8B	B-15	3C482-22-12B	B-5	3CF82-22-12	B-9
3B282-10-10	B-15	3C482-28-16-K	B-5	3CF82-6-4	B-9
3B282-10-10B	B-15	3C482-6-4	B-5	3CF82-8-4	B-9
3B282-10-8	B-15	3C482-6-4B	B-5	3D082-10-6	B-10
3B282-12-12	B-15	3C482-8-4	B-5	3D082-10-6B	B-10
3B282-12-12B	B-15	3C482-8-4B	B-5	3D082-10-6C	B-10
3B282-16-16-K	B-15	3C482-8-4C	B-5	3D082-12-6	B-10
3B282-4-4	B-15	3C582-10-4	B-6	3D082-12-6B	B-10
3B282-4-4B	B-15	3C582-10-4C	B-6	3D082-12-6C	B-10
3B282-6-6	B-15	3C582-10-6	B-6	3D082-15-8	B-10
3B282-6-6B	B-15	3C582-10-6B	B-6	3D082-15-8B	B-10
3B282-8-8	B-15	3C582-10-6C	B-6	3D082-15-8BK	B-10
3B282-8-8B	B-15	3C582-12-6	B-6	3D082-15-8C	B-10

Index of part numbers

Part No.	Page	Part No.	Page	Part No.	Page
3D082-18-10	B-10	515H-5	E-6	55SG-8	F-5
3D082-18-8	B-10	515H-6	E-6	560-10	E-9
3D082-22-12	B-10	515H-8	E-6	560-12	E-9
3D082-22-12B	B-10	518C-10	E-11	560-3	E-9
3D082-6-4	B-10	518C-12	E-11	560-4	E-9
3D082-8-4	B-10	518C-16	E-11	560-5	E-9
3D982-10-10	B-16	518C-2	E-11	560-6	E-9
3D982-10-10B	B-16	518C-3	E-11	560-8	E-9
3D982-12-12	B-16	518C-4	E-11	575X-3	E-23
3D982-12-12B	B-16	518C-5	E-11	575X-4	E-23
3D982-2-4	B-16	518C-6	E-11	575X-6	E-23
3D982-4-4	B-16	518C-8	E-11	575X-8	E-23
3D982-4-4B	B-16	520N-3	E-18	580N-10	E-20
3D982-4-6	B-16	520N-4	E-18	580N-12	E-20
3D982-4-6B	B-16	520N-4WHT	E-18	580N-16	E-20
3D982-6-6	B-16	520N-5	E-18	580N-4	E-20
3D982-6-6B	B-16	520N-6	E-18	580N-6	E-20
3D982-8-8	B-16	520N-6WHT	E-18	580N-8	E-20
3D982-8-8B	B-16	520N-8	E-18	588N-10	E-21
3DAB-10-04	E-97	526BA-3	E-39	588N-12	E-21
3DAB-8-025	E-97	526BA-4	E-39	588N-16	E-21
3FF82-10-6B	B-24	526BA-6	E-39	588N-4	E-21
3FF82-12-6B	B-24	528N-3	E-19	588N-6	E-21
3FF82-14-8B	B-24	528N-4	E-19	588N-8	E-21
3FF82-16-8B	B-24	528N-5	E-19	590-10	E-22
3FF82-18-10B	B-24	528N-6	E-19	590-12	E-22
3FF82-22-12B	B-24	528N-8	E-19	590-16	E-22
3FF82-6-4B	B-24	540N-12	E-8	590-3	E-22
3FF82-8-4B	B-24	540N-2	E-8	590-4	E-22
3JC82-10-10	B-23	540N-3	E-8	590-6	E-22
3JC82-10-12	B-23	540N-4	E-8	590-8	E-22
3JC82-12-12	B-23	540N-5	E-8	5CNG-12	D-2, E-40
3JC82-4-4	B-23	540N-6	E-8	5CNG-16	D-2, E-40
3JC82-6-6	B-23	540N-8	E-8	5CNG-3*	D-2, E-40
3JC82-6-6-SM	B-23	550H-10	E-7	5CNG-4	D-2, E-40
3JC82-8-10	B-23	550H-12	E-7	5CNG-6	D-2, E-40
3JC82-8-10-SM	B-23	550H-16	E-7	5CNG-8	D-2, E-40
3JC82-8-6-SM	B-23	550H-3	E-7	5PSG-4	F-5
3JC82-8-8	B-23	550H-4	E-7	5PSG-6	F-5
3JC82-8-8-SM	B-23	550H-4-4	E-43	5PSG-8	F-5
3NM82-12-12B	B-25	550H-5	E-7	60	G-9
3NM82-6-8B	B-25	550H-5-5	E-43	611050G	H-26
3NM82-8-8B	B-25	550H-6	E-7	8.2	G-10
3PSG-4	F-5	550H-6-6	E-43	8.204	F-7
3PSG-6	F-5	550H-8	E-7	8.207	F-7
3YW82-10-6C-ROUND	B-25	550H-8-8	E-43	80	G-7
3YW82-12-8C-ROUND	B-25	55LT-12	E-13	80-05	G-7
3YW82-18-10C-ROUND	B-25	55LT-2	E-13	80-06	G-7
3YW82-6-4C-ROUND	B-25	55LT-3	E-13	80-07	G-7
3YW82-8-4C-ROUND	B-25	55LT-4	E-13	80-08	G-7
50	G-8	55LT-5	E-13	80-09	G-7
510A-3	E-10	55LT-6	E-13	80-12	G-7
510A-4	E-10	55LT-8	E-13	80-14	G-7
510A-6	E-10	55SG-12	F-5	80-17	G-7
510A-8	E-10	55SG-4	F-5	80-20	G-7
515H-3	E-6	55SG-5	F-5	80-22	G-7
515H-4	E-6	55SG-6	F-5	80-24	G-7

Index



Part No.	Page	Part No.	Page	Part No.	Page
80-28	G-7	939/939B-20	C-10	HG-150	F-3
80-32	G-7	939/939B-24	C-10	HG-200	F-3
80-ZB01	G-7	939/939B-32	C-10	HG-350	F-3
80-ZB02	G-7	939/939B-6	C-10	PD-1-5MM	G-10
80-ZB03	G-7	939/939B-8	C-10	PG-038	F-3
80-ZB04	G-7	94C-001-PFD	G-6	PG-050	F-3
80-ZB05	G-7	A2M10	F-6	PG-062	F-3
80-ZB06	G-7	A2M3	F-6	PG-075	F-3
80-ZB07	G-7	A2M4	F-6	PG-088	F-3
80C-R01	G-5	A2M6	F-6	PG-100	F-3
82C-R01	G-5	A2M8	F-6	PG-119	F-3
82CE-0EP	G-3	AM-03	F-6	PG-138	F-3
830M-10-xxx-RL	B-2	AM-04	F-6	PG-188	F-3
830M-12-xxx-RL	B-2	AM-06	F-6	PTA-025	E-15
830M-4-xxx-RL	B-2	AM-08	F-6	PTA-04	E-15
830M-6-xxx-RL	B-2	AM-10	F-6	PTA-05	E-15
830M-8-xxx-RL	B-2	AM-13	F-6	PTA-06	E-15
838M-10-RL	B-3	AM-16	F-6	SG-060	F-2
838M-12-RL	B-3	AM-20	F-6	SG-066	F-2
838M-4-RL	B-3	AR-04	F-6	SG-072	F-2
838M-6-RL	B-3	AR-08	F-6	SG-084	F-2
838M-8-RL	B-3	AR-08C	F-6	SG-097	F-2
83CE-083	G-4	AR-10	F-6	SG-106	F-2
83CE-380	G-4	AR-16	F-6	SG-113	F-2
853009-10	F-7	C3AB-12-06	E-96	SG-122	F-2
853009-12	F-7	C3AB-6-025	E-96	SG-131	F-2
853009-14	F-7	C3AB-8-04	E-96	SG-155	F-2
853009-16	F-7	CNGG5-12-KIT	F-6	SG-161	F-2
853009-17	F-7	CNGG5-16-KIT	F-6	SG-166	F-2
853009-18	F-7	CNGG5-4-KIT	F-6	SG-182	F-2
853009-21	F-7	CNGG5-6-KIT	F-6	SG-209	F-2
853009-22	F-7	CNGG5-8-KIT	F-6	SG-220	F-2
853009-26	F-7	DP-10-10-6BK	B-28	SG-232	F-2
853009-8	F-7	DP-15-15-8BK	B-28	SG-270	F-2
85C-0AP	G-3	DP-6-6-4BK	B-28	SG-292	F-2
85CE-061	G-3	DP-8-8-4BK	B-28	SG-369	F-2
85CE-0HP	G-3	DR-10-6-6BK	B-29	SMM100	G-9
89CE-061	G-4	DR-15-8-8BK	B-29	ST250	G-8
8LPG-3	D-4, E-41	DR-6-4-4BK	B-29	TH 4-4	G-8
8LPG-3-FR*	D-4, E-41	FS-F-10	F-4	TH 5-3	G-9
8LPG-4	D-4, E-41	FS-F-11	F-4	TH8-380.E	G-2
8LPG-4-FR*	D-4, E-41	FS-F-12	F-4	Tape-FV	F-7
8LPG-5	D-4, E-41	FS-F-14	F-4	VW121-8937*	B-26
8LPG-6	D-4, E-41	FS-F-16	F-4	VW121-8938	B-26
919U-12	C-8	FS-F-18	F-4	VW121-8939	B-26
919U-16	C-8	FS-F-20	F-4	VW121-8940	B-26
919U-4	C-8	FS-F-22	F-4	VW121-8941**	B-26
919U-6	C-8	FS-F-24	F-4		
919U-8	C-8	FS-F-28	F-4		
929/929B-12	C-9	FS-F-32	F-4		
929/929B-16	C-9	FS-F-38	F-4		
929/929B-4	C-9	FS-F-40	F-4		
929/929B-6	C-9	FS-F-48	F-4		
929/929B-8	C-9	FS-F-60	F-4		
939/939B-10	C-10	HG-075	F-3		
939/939B-12	C-10	HG-100	F-3		
939/939B-16	C-10	HG-125	F-3		

Index of part numbers

Part No.	Page	Part No.	Page	Part No.	Page
----------	------	----------	------	----------	------

--	--	--	--	--	--

--	--	--	--	--	--

Index

Parker's Motion & Control Technologies

At Parker, we're guided by a relentless drive to help our customers become more productive and achieve higher levels of profitability by engineering the best systems for their requirements. It means looking at customer applications from many angles to find new ways to create value. Whatever the motion and control technology need, Parker has the experience, breadth of product and global reach to consistently deliver. No company knows more about motion and control technology than Parker. For further information call free on 08000 27 27 5374.



AEROSPACE

Key Markets

- Aircraft engines
- Business & general aviation
- Commercial transports
- Land-based weapons systems
- Military aircraft
- Missiles & launch vehicles
- Regional transports
- Unmanned aerial vehicles

Key Products

- Flight control systems & components
- Fuel conveyance systems
- Fluid metering/delivery & automation devices
- Fuel systems & components
- Hydraulic systems & components
- Inert nitrogen generating systems
- Pneumatic systems & components
- Wheels & brakes



CLIMATE CONTROL

Key Markets

- Agriculture
- Air conditioning
- Food, beverage & dairy
- Land-based weapons systems
- Processing
- Precision cooling
- Oil & gas
- Transportation
- Regional transports

Key Products

- CO₂ controls
- Electronic controllers
- Filter driers
- Heat shut-off valves
- Hose & fittings
- Pressure regulating valves & refrigerant distributors
- Safety relief valves
- Stand-off valves
- Thermostatic expansion valves



PROCESS CONTROL

Key Markets

- Chemical & refining
- Food, beverage & dairy
- Medical & dental
- Microelectronics
- Oil & gas
- Power generation
- Oil & gas

Key Products

- Analytical sample conditioning products & systems
- Fluoropolymer chemical delivery fittings, valves & pumps
- High purity gas delivery fittings, valves & regulators
- Instrumentation fittings, valves & regulators
- Medium pressure fittings & valves
- Process control manifolds



FILTRATION

Key Markets

- Industrial machinery
- Life sciences
- Marine
- Mobile equipment
- Oil & gas
- Power generation
- Process
- Transportation
- Oil & gas

Key Products

- Analytical gas generators
- Condition monitoring
- Condensation air & gas filters
- Engine air, fuel & oil filtration & systems
- Hydraulic, lubrication & coolant filters
- Process, chemical, water & micronation filters
- Piping, hydrogen & zero air generators



FLUID & GAS HANDLING

Key Markets

- Aerospace
- Agriculture
- Bulk chemical handling
- Construction machinery
- Food & beverage
- Fuel & gas delivery
- Industrial machinery
- Mobile
- Oil & gas
- Transportation
- Welding

Key Products

- Brass fittings & valves
- Diagnostic equipment
- Industrial hose
- Fluid conveyance systems
- PPE & PPA hose, tubing & fittings
- Rubber fittings & components
- 6 Thermoplastic hose
- Tube fittings & adapters
- Quick disconnects



HYDRAULICS

Key Markets

- Aerial lift
- Agriculture
- Construction machinery
- Forestry
- Industrial machinery
- Mining
- Oil & gas
- Power generation & energy
- Truck hydraulics

Key Products

- Diagnostic equipment
- Hydraulic cylinders & accumulators
- Hydraulic motors & pumps
- Hydraulic systems & controls
- Power take-offs
- Rubber & thermoplastic hose
- Ropes & couplings
- Tube fittings & adapters
- Quick disconnects



PNEUMATICS

Key Markets

- Conveyor & material handling
- Factory automation
- Life science & medical
- Machine tools
- Packaging machinery
- Transportation & automotive
- Air preparation
- Brass fittings & valves
- Manifolds
- Pneumatic accessories
- Pneumatic actuators & grippers
- Pneumatic valves & controls
- Quick disconnects
- Rotary actuators
- Rubber & thermoplastic hose & couplings
- Structural extrusions
- Thermoplastic tubing & fittings
- Vacuum generators, cups & sensors



ELECTROMECHANICAL

Key Markets

- Factory automation
- Life science & medical
- Machine tools
- Packaging machinery
- Paper machinery
- Plastics machinery & conveying
- Primary metals
- Semiconductor & electronics
- Textile
- Wire & cable

Key Products

- ACDC drives & systems
- Electric actuators
- Controllers
- Gantry robots
- Gearheads
- Human machine interfaces
- Industrial PCs
- Inverters
- Linear motors, slides and stages
- Precision stages
- Stepper motors
- Servo motors, drives & controls
- Structural extrusions



SEALING & SHIELDING

Key Markets

- Aerospace
- Chemical processing
- Consumer
- Energy, oil & gas
- Fluid power
- General industrial
- Information technology
- Life sciences
- Military
- Semiconductor
- Telecommunications
- Transportation
- Oil & gas

Key Products

- Dynamic seals
- Elastomeric o-rings
- EMI shielding
- Extruded & precision-cut, fabricated elastomeric seals
- Human machine interface stages
- Homogeneous & inerted elastomeric
- High temperature metal seals
- Metal & plastic retained composite seals
- Thermal management



ENGINEERING YOUR SUCCESS.



Parker Worldwide

AE – UAE, Dubai
Tel: +971 4 8127100
parker.me@parker.com

AR – Argentina, Buenos Aires
Tel: +54 3327 44 4129

AT – Austria, Wiener Neustadt
Tel: +43 (0)2622 23501-0
parker.austria@parker.com

AT – Eastern Europe, Wiener Neustadt
Tel: +43 (0)2622 23501 900
parker.easteurope@parker.com

AU – Australia, Castle Hill
Tel: +61 (0)2-9634 7777

AZ – Azerbaijan, Baku
Tel: +994 50 2233 458
parker.azerbaijan@parker.com

BE/LU – Belgium, Nivelles
Tel: +32 (0)67 280 900
parker.belgium@parker.com

BR – Brazil, Cachoeirinha RS
Tel: +55 51 3470 9144

BY – Belarus, Minsk
Tel: +375 17 209 9399
parker.belarus@parker.com

CA – Canada, Milton, Ontario
Tel: +1 905 693 3000

CH – Switzerland, Etoy
Tel: +41 (0)21 821 87 00
parker.switzerland@parker.com

CL – Chile, Santiago
Tel: +56 2 623 1216

CN – China, Shanghai
Tel: +86 21 2899 5000

CZ – Czech Republic, Klecany
Tel: +420 284 083 111
parker.czechrepublic@parker.com

DE – Germany, Kaarst
Tel: +49 (0)2131 4016 0
parker.germany@parker.com

DK – Denmark, Ballerup
Tel: +45 43 56 04 00
parker.denmark@parker.com

ES – Spain, Madrid
Tel: +34 902 330 001
parker.spain@parker.com

FI – Finland, Vantaa
Tel: +358 (0)20 753 2500
parker.finland@parker.com

FR – France, Contamine s/Arve
Tel: +33 (0)4 50 25 80 25
parker.france@parker.com

GR – Greece, Athens
Tel: +30 210 933 6450
parker.greece@parker.com

HK – Hong Kong
Tel: +852 2428 8008

HU – Hungary, Budapest
Tel: +36 1 220 4155
parker.hungary@parker.com

IE – Ireland, Dublin
Tel: +353 (0)1 466 6370
parker.ireland@parker.com

IN – India, Mumbai
Tel: +91 22 6513 7081-85

IT – Italy, Corsico (MI)
Tel: +39 02 45 19 21
parker.italy@parker.com

JP – Japan, Tokyo
Tel: +81 (0)3 6408 3901

KR – South Korea, Seoul
Tel: +82 2 559 0400

KZ – Kazakhstan, Almaty
Tel: +7 7272 505 800
parker.easteurope@parker.com

LV – Latvia, Riga
Tel: +371 6 745 2601
parker.latvia@parker.com

MX – Mexico, Apodaca
Tel: +52 81 8156 6000

MY – Malaysia, Shah Alam
Tel: +60 3 7849 0800

NL – The Netherlands, Oldenzaal
Tel: +31 (0)541 585 000
parker.nl@parker.com

NO – Norway, Asker
Tel: +47 66 75 34 00
parker.norway@parker.com

NZ – New Zealand, Mt Wellington
Tel: +64 9 574 1744

PL – Poland, Warsaw
Tel: +48 (0)22 573 24 00
parker.poland@parker.com

PT – Portugal, Leca da Palmeira
Tel: +351 22 999 7360
parker.portugal@parker.com

RO – Romania, Bucharest
Tel: +40 21 252 1382
parker.romania@parker.com

RU – Russia, Moscow
Tel: +7 495 645-2156
parker.russia@parker.com

SE – Sweden, Spånga
Tel: +46 (0)8 59 79 50 00
parker.sweden@parker.com

SG – Singapore
Tel: +65 6887 6300

SK – Slovakia, Banská Bystrica
Tel: +421 484 162 252
parker.slovakia@parker.com

SL – Slovenia, Novo Mesto
Tel: +386 7 337 6650
parker.slovenia@parker.com

TH – Thailand, Bangkok
Tel: +662 717 8140

TR – Turkey, Istanbul
Tel: +90 216 4997081
parker.turkey@parker.com

TW – Taiwan, Taipei
Tel: +886 2 2298 8987

UA – Ukraine, Kiev
Tel: +380 44 494 2731
parker.ukraine@parker.com

UK – United Kingdom, Warwick
Tel: +44 (0)1926 317 878
parker.uk@parker.com

US – USA, Cleveland
Tel: +1 216 896 3000

VE – Venezuela, Caracas
Tel: +58 212 238 5422

ZA – South Africa, Kempton Park
Tel: +27 (0)11 961 0700
parker.southafrica@parker.com

EU 2010/06-34

European Product Information Centre
Free phone: 00 800 27 27 5374
(from AT, BE, CH, CZ, DE, EE, ES, FI, FR, IE, IL, IS, IT, LU, MT, NL, NO, PT, SE, SK, UK)

